

Thule Rapid System Kit 1633

> Instructions

NISSAN Leaf, 5-dr Hatchback, 10- / *11-

*North America

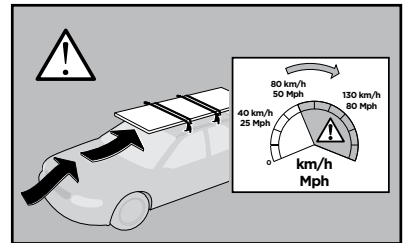
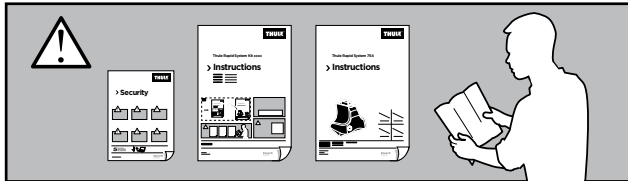
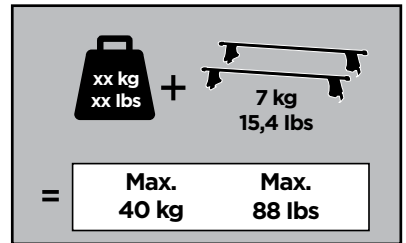
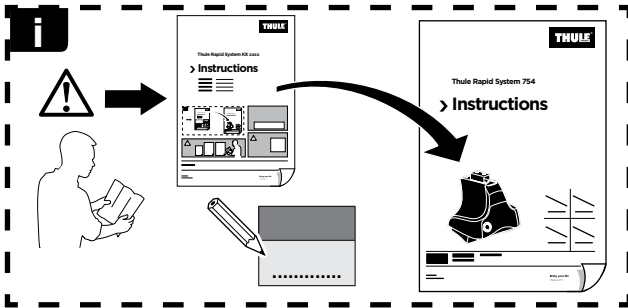

ISO 11154-E

141633

C.20121115
519-1633-01

Bring your life

thule.com



373 x1

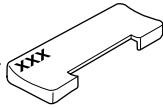

374 x1

375 x1

376 x1



1180 x2



1181 x2



x1

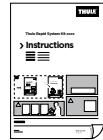

x1

1

	X (scale)	X (mm)	X (inch)
NISSAN Leaf, 5-dr Hatchback, 10- / *11-	41	1061	41 ³/₄

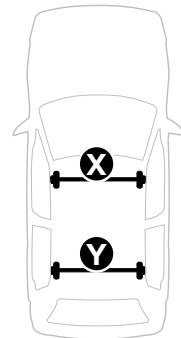
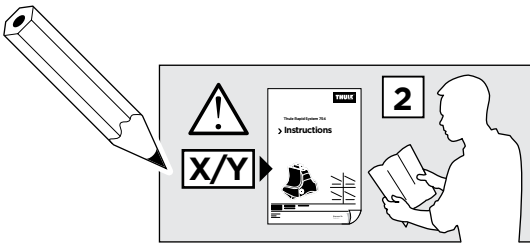

	Y (scale)	Y (mm)	Y (inch)
NISSAN Leaf, 5-dr Hatchback, 10- / *11-	31,5	966	38

2

NISSAN Leaf, 5-dr Hatchback, 10- / *11-

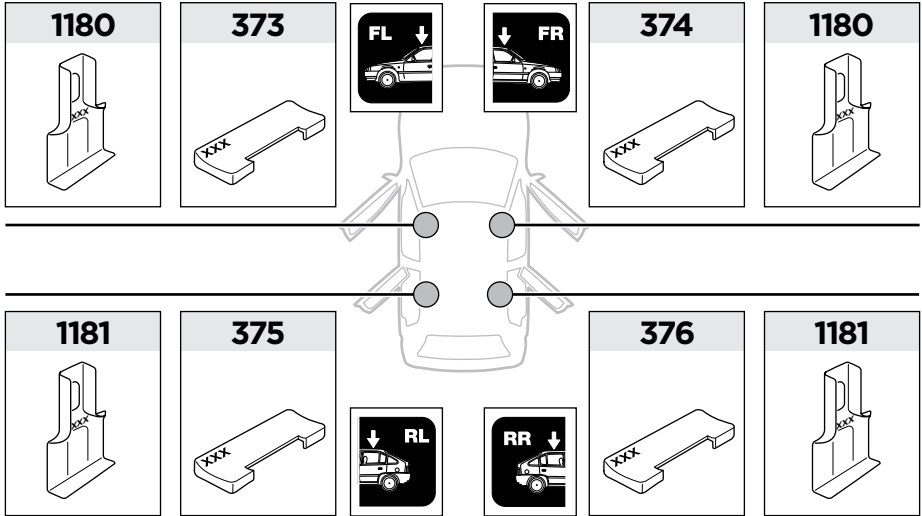

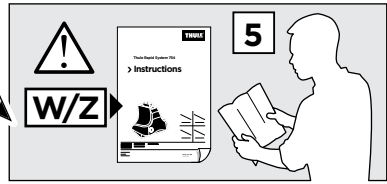
3

	W (mm)	Z (mm)	W (inch)	Z (inch)
NISSAN Leaf , 5-dr Hatchback, 10- / *11-	280	710	11	28

