

- EN Fitting Instructions for Basic Carrier
- D Montageanleitung für Basisträgersystem
- ES Instrucciones de montaje para el sistema de transporte.
- F Instructions de montage pour Basic Carrier
- NO Monteringsanvisning for takstativ
- PT Instruções de Montagem para sistema de transporte.
- RU Установочные Инструкции для Поперечных Балок

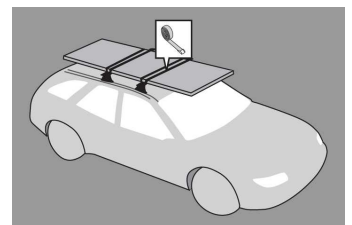

x 4

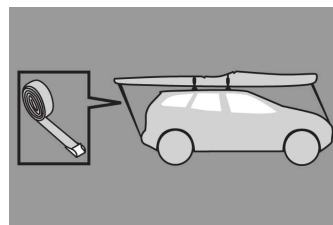
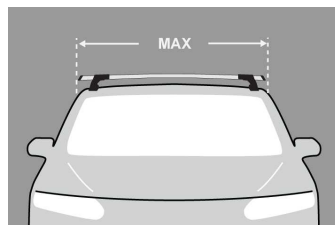
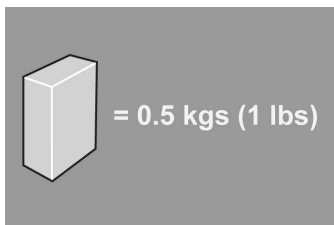

x 4



x 4



x 4



		MAX kgs (lbs)	
	🚩	W/P	WHD
<b>Toyota</b>			
Land Cruiser Prado , 5dr SUV 03-09	EU	75 kgs (165 lbs)	75 kgs (165 lbs)
Land Cruiser Prado GX, 5dr SUV Dec 09-+	NZ	75 kgs (165 lbs)	100 kgs (220 lbs)
Land Cruiser Prado , 5dr SUV Mar 03-Nov 09	NZ	75 kgs (165 lbs)	75 kgs (165 lbs)
Land Cruiser Prado 120 Series, 5dr SUV Mar 03-Oct 09	AU	75 kgs (165 lbs)	75 kgs (165 lbs)
Land Cruiser Prado GX, 5dr SUV Nov 09-+	AU	75 kgs (165 lbs)	100 kgs (220 lbs)
Land Cruiser 200 Series, 5dr SUV 07-+	US	75 kgs (165 lbs)	75 kgs (165 lbs)
Land Cruiser 200 Series, 5dr SUV 07-+	EU	75 kgs (165 lbs)	75 kgs (165 lbs)
Land Cruiser 100 Series, 5dr SUV 98-07	EU	75 kgs (165 lbs)	75 kgs (165 lbs)
Land Cruiser 100 Series, 5dr SUV 98-07	US	75 kgs (165 lbs)	75 kgs (165 lbs)
Land Cruiser 100 Series, 5dr SUV 98-07	ZA	75 kgs (165 lbs)	75 kgs (165 lbs)
Land Cruiser 100 Series, 5dr SUV Apr 98-Jun 07	AU	75 kgs (165 lbs)	75 kgs (165 lbs)
Land Cruiser 100 Series, 5dr SUV Apr 98-Oct 07	NZ	75 kgs (165 lbs)	75 kgs (165 lbs)
Land Cruiser 200 Series, 5dr SUV Aug 07-+	AU	75 kgs (165 lbs)	75 kgs (165 lbs)
Land Cruiser 200 Series, 5dr SUV Nov 07-+	NZ	75 kgs (165 lbs)	75 kgs (165 lbs)
Rav 4 , 3dr SUV 00-05	ZA	75 kgs (165 lbs)	80 kgs (176 lbs)
Rav 4 , 3dr SUV 00-05	ZA	75 kgs (165 lbs)	80 kgs (176 lbs)
Rav 4 , 3dr SUV 00-06	EU	75 kgs (165 lbs)	80 kgs (176 lbs)
Rav 4 , 3dr SUV 00-06	EU	75 kgs (165 lbs)	80 kgs (176 lbs)
Rav 4 , 3dr SUV 94-00	US	75 kgs (165 lbs)	75 kgs (165 lbs)
Rav 4 , 3dr SUV 94-00	EU	75 kgs (165 lbs)	75 kgs (165 lbs)
Rav 4 , 3dr SUV 94-99	ZA	75 kgs (165 lbs)	75 kgs (165 lbs)
Rav 4 , 3dr SUV Jun 00-Jan 06	NZ	75 kgs (165 lbs)	80 kgs (176 lbs)
Rav 4 , 3dr SUV Jun 00-Jan 06	NZ	75 kgs (165 lbs)	80 kgs (176 lbs)
Rav 4 20 Series, 3dr SUV Jun 00-Jan 06	AU	75 kgs (165 lbs)	80 kgs (176 lbs)
Rav 4 20 Series, 3dr SUV Jun 00-Jan 06	AU	75 kgs (165 lbs)	80 kgs (176 lbs)
Rav 4 , 3dr SUV Jun 94-May 00	AU	75 kgs (165 lbs)	75 kgs (165 lbs)
Rav 4 , 3dr SUV Jun 94-May 00	NZ	75 kgs (165 lbs)	75 kgs (165 lbs)
Rav 4 , 5dr SUV 00-04	EU	75 kgs (165 lbs)	80 kgs (176 lbs)
Rav 4 , 5dr SUV 00-06	ZA	75 kgs (165 lbs)	80 kgs (176 lbs)
Rav 4 , 5dr SUV 94-00	EU	75 kgs (165 lbs)	75 kgs (165 lbs)
Rav 4 , 5dr SUV 94-99	ZA	75 kgs (165 lbs)	75 kgs (165 lbs)
Rav 4 , 5dr SUV Dec 94-May 00	NZ	75 kgs (165 lbs)	75 kgs (165 lbs)
Rav 4 , 5dr SUV Jul 95-May 00	AU	75 kgs (165 lbs)	75 kgs (165 lbs)
Rav 4 , 5dr SUV Jun 00-Jan 06	NZ	75 kgs (165 lbs)	80 kgs (176 lbs)
Rav 4 20 Series, 5dr SUV Jun 00-Jan 06	AU	75 kgs (165 lbs)	80 kgs (176 lbs)

## Lexus

LX470 , 5dr SUV Apr 98-Jul 07

AU 75 kgs (165 lbs) 75 kgs (165 lbs)

LX470 , 5dr SUV May 98-Oct 07

NZ 75 kgs (165 lbs) 75 kgs (165 lbs)

## Suzuki

SX4 , 5dr Hatch 06-+

EU 40 kgs (88 lbs) 40 kgs (88 lbs)

SX4 , 5dr Hatch 06-+

ZA 40 kgs (88 lbs) 40 kgs (88 lbs)

SX4 Sportback, 5dr Hatch 07-+

US 40 kgs (88 lbs) 40 kgs (88 lbs)

SX4 , 5dr Hatch Mar 07-+

NZ 40 kgs (88 lbs) 40 kgs (88 lbs)

SX4 , 5dr Hatch Mar 07-+

AU 40 kgs (88 lbs) 40 kgs (88 lbs)

## First Time Installation



- Remove parts from inside the package and check. Contact your dealer if any parts are missing or damaged.



- This kit fits type A, B, C and D.
- These instructions show type A crossbar fitted. They also apply to type B, C and D.



- Use keys to remove covers.



- Use hex screwdriver to reverse adjusting screw 10 turns.



- Press adjusting screw and pull crossbar legs out. Refer to the crossbar instructions for crossbar adjustment.
- Ensure each end of the crossbar is adjusted equally.

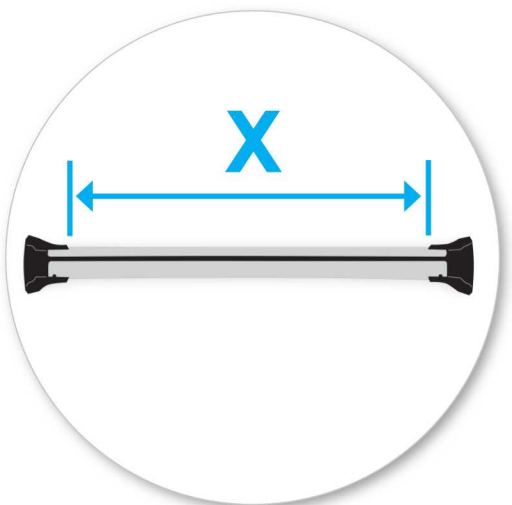

- Adjust crossbar in or out to suit vehicle. Refer to the crossbar instructions for crossbar adjustment.
- Ensure that the crossbar is adjusted evenly at both ends.
- Please check the rear of this manual for information relating specifically to your vehicle.

- Tighten adjusting screw to 5 Nm (3.7 ft lb).



- Remove plastic clamp block by gripping bar leg with fingers and push firmly with thumbs until clamp block drops out behind leg.

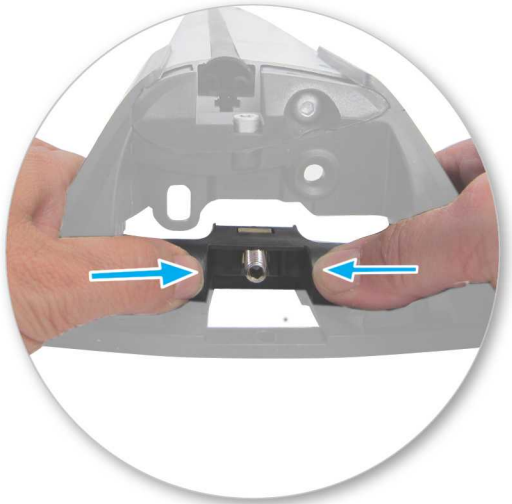

- Select plastic internal block (from fitting kit) and insert into foot.
- Repeat for all legs.





- Fit rubber pad (supplied with crossbar) to foot.
- Make sure the pad fits into the holes underneath the foot.
- Repeat for all legs.

## Fitment



- Open or remove fixed-point covers.
- Fixed point may vary to those pictured.



- Hook clamps into the fixed points on the vehicle.



- Ensure internal clamp sits upright.
- Repeat for all four positions.

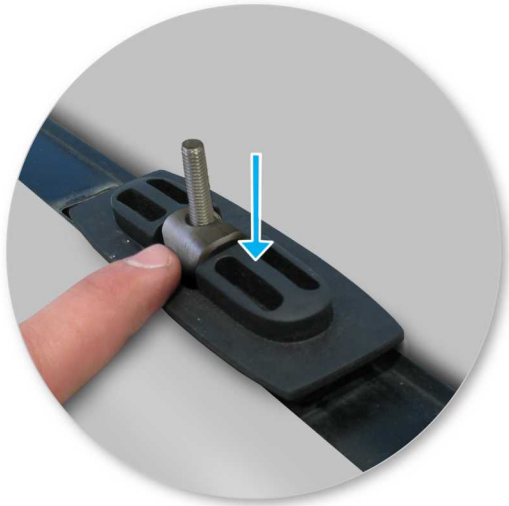

- Place ditch mould insert over the clamp.



- Mount crossbars over clamps.





- Tighten the red plastic knob. The side with the nut showing should be facing up.



- Ensure the red plastic knob is in the position shown when fully tightened.
- Repeat for all legs.



- Check crossbar is securely attached to the vehicle.
- Use keys to fit and lock covers

**CAUTION: Recheck all fasteners immediately after a load is applied to the crossbars.  
Regularly check screws are tight.**

---

## Maintenance

- Clean the car roof and surfaces of the product that will be in contact with the car roof.
- Follow the fitting instructions for fitting the product to your vehicle. Make sure all steps are carried out in order.
- Set crossbars a minimum distance of 700mm (27 1/2") apart where no other distance is specified in the fitting instructions. This is especially important when carrying long loads.
- Check unit is securely attached whenever you refit it to the vehicle. If the unit feels loose, refer to the fitting instructions and readjust.
- Some glass/panoramic roofs and radio antennae may not be able to be used when the product is fitted.
- Do not modify this product.
- Refer to the maximum permitted load capacity specified in the fitting instructions. Do not exceed the vehicle manufacturers roof load rating if it is lower than the maximum load capacity specified in the fitting instructions.
- Long loads should be secured with non-elastic straps to the front and rear of the vehicle.
- Objects with pointed ends (e.g. ski poles) should be carried with the pointed ends to the rear of the vehicle.
- Remove all loose or removable objects from the load prior to loading.
- Make sure all loads are securely fastened with non-elastic straps. Check regularly during longer journeys.
- A loaded roof rack system can alter the performance of your vehicle. Be especially aware of the effects of side winds, changing of direction, and braking performance. Avoid rapid acceleration and deceleration. Drive carefully.
- Note that the total height of the vehicle increases when upright loads are carried.
- Products should be locked during transport if they have locks fitted.
- Check and replace worn out or defective parts.

- Keep the product clean and maintained.
  - Never drive into a car wash with the roof rack system fitted.
  - Lubricate locks and adjusting screws at regular intervals.
  - Remove the products from the vehicle when not in use. Make sure all loose parts are stored safely.
- 

- Yakima Products, Inc.  
15025 SW Koll Pkwy.  
Beaverton, OR 97006-6056  
USA

[www.whispbar.com](http://www.whispbar.com)  
[www.whispbar.ca](http://www.whispbar.ca)  
[www.whispbar.eu](http://www.whispbar.eu)  
[www.whispbar.co.uk](http://www.whispbar.co.uk)  
[www.whispbar.co.za](http://www.whispbar.co.za)

---

## Erstinstallation



- Komponenten aus der Verpackung nehmen und überprüfen. Setzen Sie sich mit Ihrem Händler in Verbindung, sollten Teile fehlen oder beschädigt sein!



- Dieses Kit ist für die Typen A, B, C und D.
- Dargestellt ist der Querträger des Typs A. Die Anweisungen gelten aber auch für die Typen B, C und D!



- Abdeckungen mit Schlüsseln abnehmen.



- Innensechskantschlüssel benutzen und Stellschraube mit 10 Umdrehungen lösen.



- Befestigungsschraube eindrücken und Querträgerschenkel ausziehen. Siehe Anweisungen für das Einstellen der Querträger!
- Sicherstellen, dass beide Enden der Querträger gleich lang eingestellt sind (Maß 'x', s. Abb.).

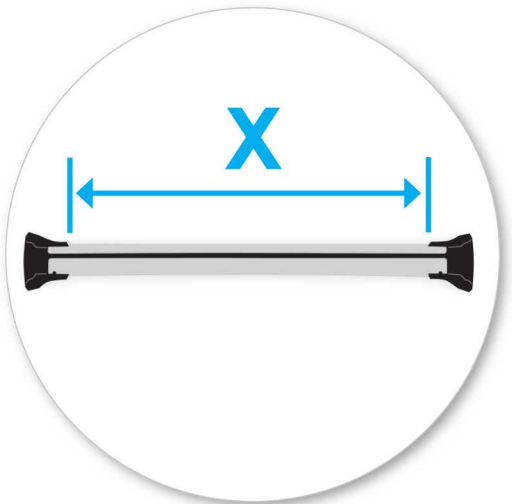

- Querträger auf erforderliche Breite einstellen. Siehe dazu Montageanleitung für die Querträger.
- Sicherstellen, dass die Querträger auf beiden Seiten gleich lang eingestellt ist.
- Im hinteren Teil dieser Bedienungsanleitung finden Sie Informationen speziell für Ihr Fahrzeug.

- Stellschraube mit 5 Nm / 3.7 ft lb anziehen.



- Klemmblock nach hinten drücken und so entfernen.

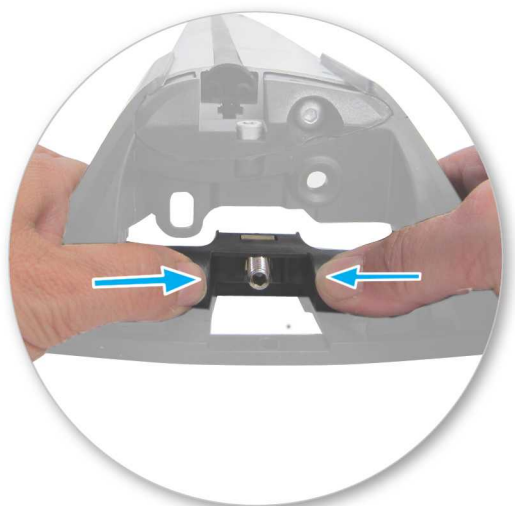

- Innenblock aus dem Montage-Kit in den Fuß einsetzen.
- Montage bei allen Beinen wiederholen.





- Montieren Sie das Gummi-Pad (wird zusammen mit der Querstange geliefert) an dem Fuß.
- Achten Sie darauf, dass die Pads in die Öffnungen unter den Füßen passen.
- Montage bei allen Beinen wiederholen.

## Befestigung



- Abdeckungen der Befestigungspunkte am Fahrzeug entfernen.
- Fixierungspunkte können von den gezeigten abweichen.



- Haken Sie die Klammern in die Fixierungspunkte am Fahrzeug.





- Stellen Sie sicher, dass die Klammer innen aufrecht sitzt.
- Dies an allen vier Punkten wiederholen.



- Platzieren Sie die Dachrillenleiste über der Klammer.



- Montieren Sie die Querstange über der Dachrillenklammer.



- Rote Flügelmutter festziehen. Die Mutterseite sollte nach oben weisen.



- Vergewissern Sie sich, dass sich der rote Plastikknopf in der gezeigten Position befindet, nachdem er ganz angezogen wurde.
- Montage bei allen Beinen wiederholen.



- Überprüfen ob die Querträger sicher am Fahrzeug befestigt sind.
- Abdeckungen aufsetzen und mit Schlüsseln verschließen (s. Abb.).

**ACHTUNG! Schrauben regelmäßig auf festen Sitz prüfen!**

---

## Sicherheitshinweise & Tipps

- Dach sowie alle Trägerflächen, die mit dem Dach Kontakt haben reinigen.
- Träger anhand der Montageanleitung montieren. Alle Schritte unbedingt in der richtigen Reihenfolge ausführen!
- Wenn in der Anleitung nicht anders angegeben, Querträger im Abstand von min. 700 mm montieren. Dies ist besonders für lange Belastungen wichtig!
- Bei jeder neuen Montage am Fahrzeug prüfen, ob der Träger korrekt sitzt. Im Zweifelsfalle bitte in der Montageanleitung nachschauen und nachziehen!
- Aufgrund der niedrigen Bauhöhen lassen sich evtl. manche Schiebedächer und Radioantennen nicht mehr benutzen.
- Dachträger nicht eigenmächtig modifizieren!
- Max. zulässige Zuladung in der Bedienungsanleitung des Fahrzeugs beachten! Sollte die max. zulässige Dachlast des Fahrzeugs gem. Herstellerangaben niedriger sein, darf diese auf keinen Fall überschritten werden!
- Lange Lasten sollten mit nichtelastischen Gurten an Front und Heck des Fahrzeugs gesichert werden.
- Gegenstände mit spitzen Enden (Ski) sollten mit den Spitzen nach hinten transportiert werden.
- Bei Lasten mit losen oder abnehmbaren Teilen diese vor dem Beladen entfernen.
- Sicherstellen, dass alle Lasten ausreichend mit nichtelastischen Gurten gesichert sind. Während längerer Fahrten regelmäßig überprüfen!
- Dachlasten verändern das Fahr- und Bremsverhalten Ihres Fahrzeugs! Vorsicht bei Seitenwind, Richtungswechseln, Bremsmanövern! Kein schnelles Beschleunigen und Abbremsen!
- Vorsicht! Dachlasten erhöhen die Gesamthöhe des Fahrzeugs!
- Dachträger während der Reise verschließen.
- Komponenten regelmäßig überprüfen und defekte oder verschlissene Teile gegen Originalteile ersetzen.

- Träger stets sauber halten (nicht ölen oder fetten)!
- Mit montierten Dachträgern nicht in Waschanlagen einfahren.
- Schlösser und Stellschrauben regelmäßig schmieren.
- Dachgepäckträger bei Nichtgebrauch abmontieren. Alle losen Teile sicher aufbewahren!

- 
- Yakima Products, Inc.  
15025 SW Koll Pkwy.  
Beaverton, OR 97006-6056  
USA

[www.whispbar.de](http://www.whispbar.de)

---

## Primera instalación

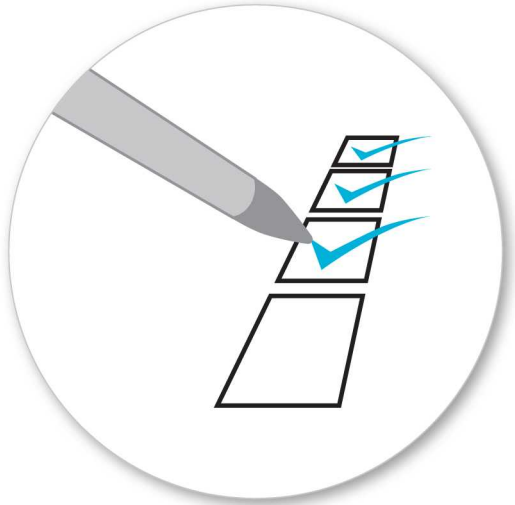

- Retire las piezas del embalaje y confirme su contenido. Póngase en contacto con su vendedor en el caso de que falten piezas o éstas estén dañadas.

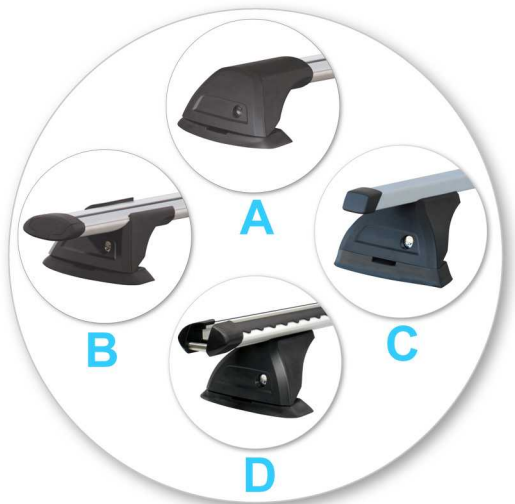

- Este kit se adecua a los tipos A, B, C y D.
- Estas instrucciones muestran la barra de techo tipo A montada. También se aplican a los tipos B, C y D.



- Utilice las llaves para retirar la tapa.



- Utilice la llave Allen para desatornillar los tornillos de ajuste en 10 vueltas.



- Presione el tornillo de ajuste y tire de los pies de la barra hacia fuera. Consulte las instrucciones de montaje de las barras para su ajuste.
- Asegúrese de que las extremidades de la barra estén ajustadas de forma igual.

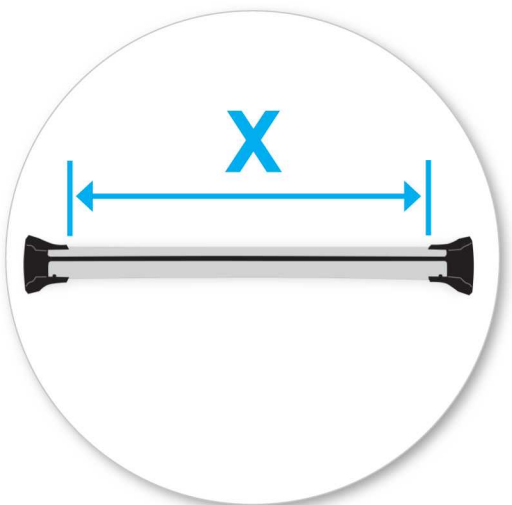

- Deslice la barra hacia dentro o hacia fuera para que se ajuste al vehículo. Consulte las instrucciones de montaje de las barras de techo para el ajuste de la barra.
- Asegúrese de que la barra esté ajustada de forma igual en cada extremidad.
- PF ver documento adjunto 1 para detalles específicos de su vehículo.



- Apriete el tornillo de ajuste a 5Nm (3.7 ft lb).

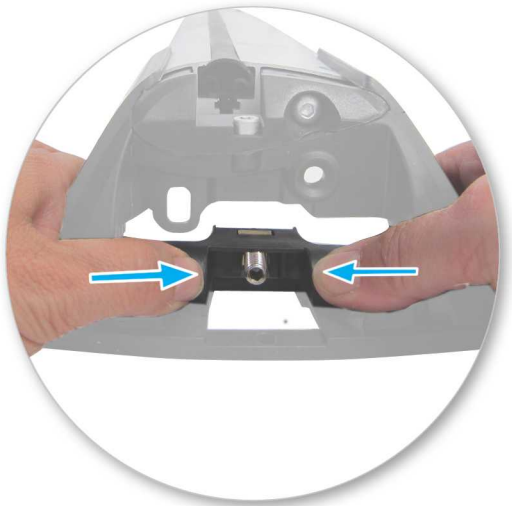

- Retire la pieza central asegurando el pie de la barra con los dedos empujando firmemente con los pulgares la pieza central hasta salir del interior del pie de la barra.



- Seleccione el bloque interno de plástico (del kit de fijación) y introdúzcalo en el pie de la barra.
- Repita para todos los pies de barra.





- Ajuste la almohadilla de goma (suministrada con las barras) a la base del pie de la barra.
- Asegúrese de que la almohadilla encaja correctamente en la base del pie de la barra.
- Repita para todos los pies de barra.

## Montaje



- Abra o retire las cubiertas de los puntos de fijación.
- Los puntos de fijación pueden diferir de los presentados en la figura.



- Acoplar los ganchos suministradas en los puntos de fijación del vehículo.



- Asegúrese de que el gancho queda correctamente posicionado.
- Repita para todas las cuatro posiciones.



- Ponga la pieza sobre el gancho.



- Monte las barras de techo sobre los ganchos.



- Apriete la rosca roja de plástico. El lado con la tuerca visible debe estar hacia arriba.



- Asegúrese de que la rosca roja de plástico esté en la posición demostrada.
- Repita para todos los pies de barra.



- Asegúrese de que la barra esté fijada al vehículo de forma segura.
- Utilice las llaves para instalar y cerrar las cubiertas.

**ATENCIÓN: Verifique regularmente si los tornillos  
están apretados.**

---

## Mantenimiento

- Limpie el techo del vehículo y las superficies del producto que estarán en contacto con el techo.
- Siga las instrucciones de montaje para la instalación del producto en su vehículo. Asegúrese de que todos los pasos se siguen correctamente.
- Ponga las barras de techo a una distancia mínima de 600mm (27 1/2") cuando no se especifique otra distancia en las instrucciones de montaje. Esto es especialmente importante al transportar cargas largas.
- Siempre que vuelva a montar las barras en su vehículo, confirme que el conjunto formado por las barras y sus pies sigue montado de forma segura. Si parecer estar suelto, consulte nuevamente las instrucciones de montaje y reajuste.
- Algunos techos solares y antenas no podrán utilizarse cuando se instalen las barras de techo.
- No intente modificar este producto.
- Considere siempre la capacidad máxima de carga especificada en instrucciones de montaje. No exceda la capacidad de carga comunicada por el fabricante del vehículo cuando esta sea inferior a la especificada en instrucciones de montaje.
- Las cargas largas deberán estar aseguradas con cintas no elásticas en la delantera y trasera del vehículo.
- Objetos puntiagudos (ej. esquís) deberán transportarse con la extremidad puntiaguda direccionada hacia a la trasera del vehículo.
- Retire todos los objetos sueltos o que puedan soltarse, antes de iniciar el transporte.
- Asegúrese de que toda la carga esté sujeta de forma segura con cintas no elásticas. Verifique regularmente en viajes largos.
- Transportar carga en el techo del vehículo cambia el comportamiento del mismo. Especial atención al efecto de viento cruzado, cambios de dirección y situaciones de frenado. Evite las aceleraciones y desaceleraciones rápidas. Conduzca con precaución.

- Tenga en cuenta que la altura total del vehículo se incrementa cuando se llevan cargas verticales.
- Los accesorios deben estar cerrados en el transporte siempre que tengan cerraduras.
- Verifique y reemplace las piezas desgastadas o defectuosas.
- Mantenga el producto limpio y con mantenimiento regular.
- No lave el coche en sistemas de lavado automático con las barras de techo montadas.
- Lubricar las cerraduras y tornillos de ajuste de forma periódica.
- Retire las barras de techo de su vehículo cuando no las utilice. Asegúrese de que mantiene todas las piezas en lugar seguro.

- 
- Yakima Products, Inc.  
15025 SW Koll Pkwy.  
Beaverton, OR 97006-6056  
USA

[www.whispbar.es](http://www.whispbar.es)  
[www.whispbar.com.mx](http://www.whispbar.com.mx)

---

## Première installation



- Retirer les pièces de contenu de l'emballage et vérifier. Contactez votre revendeur si certaines pièces sont manquantes ou endommagées.

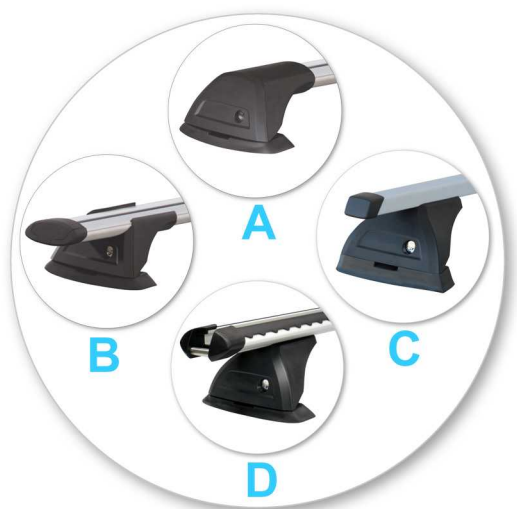

- Ce kit correspond aux types A, B, C et D.
- Ces instructions montrent la barre transversale de type A posée. Elles correspondent également aux types B, C et D.



- Utiliser les clés pour retirer les caches



- Utiliser le tournevis cruciforme pour repositionner la vis de réglage et faire 10 tours.



- Appuyer sur la vis de réglage et extraire les pieds de la barre transversale. Consulter les instructions de la barre transversale pour la régler.
- Veiller à ce que chaque extrémité de la barre transversale soit ajustée également.

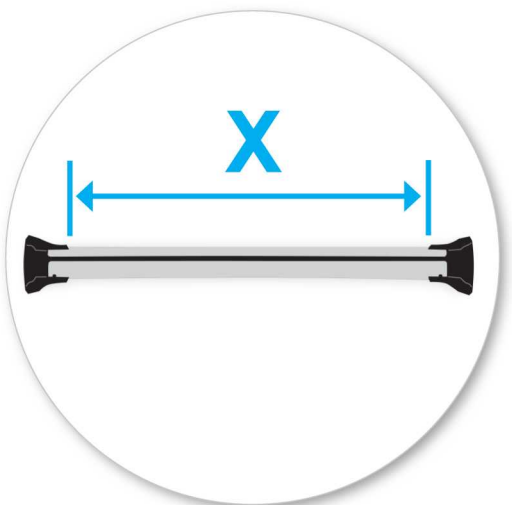

- Ajuster la barre transversale vers l'intérieur ou l'extérieur selon le véhicule. Consulter les instructions de la barre transversale pour procéder à son ajustement.
- Veiller à ce que la barre transversale soit ajustée de manière régulière aux deux extrémités.
- Veuillez consulter l'arrière de ce manuel pour obtenir des informations relatives à votre véhicule en particulier.





- Serrer la vis de réglage jusqu'à 5 Nm (3.7 ft lb).

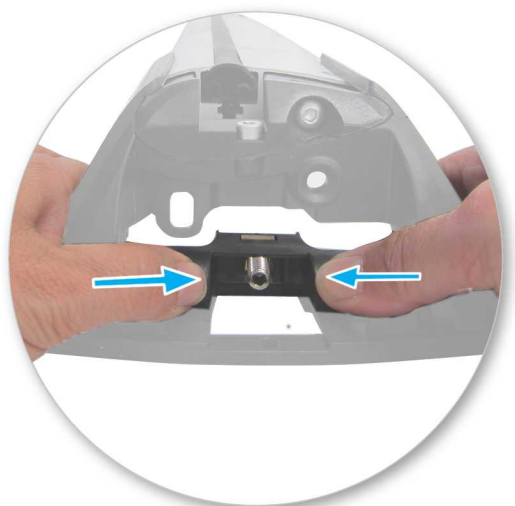

- Ôter le collier de serrage en plastique en saisissant la patte de la barre avec les doigts puis pousser fermement avec les pouces jusqu'à ce que le collier de serrage passe derrière la patte.



- Sélectionner le bloc interne en plastique (dans le kit de montage) et l'insérer dans le pied.
- Répéter l'opération pour tous les pieds.



- Placer le coussin en caoutchouc (Livré avec les barres transversales) sur le pied.
- S'assurer que le coussin s'intègre dans les orifices sous le pied.
- Répéter l'opération pour tous les pieds.

## Montage

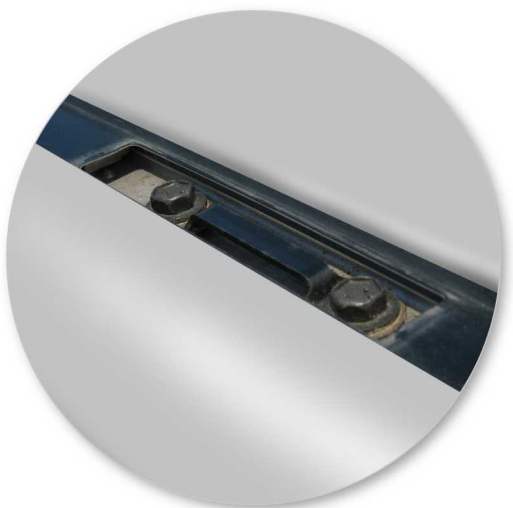

- Ouvrir ou retirer les couvercles à point fixe.
- Le point fixe pourra varier de celui représenté.



- Accrocher les fixations sur les points fixes du véhicule.



- Veiller à ce que la fixation interne soit posée bien droite.
- Répéter l'opération pour les quatre positions.



- Placer l'élément encastré de la moulure sur la fixation.



- Monter les barres transversales sur les fixations.



- Serrer le bouton en plastique rouge. Le côté avec l'écrou apparent doit être tourné vers l'avant.



- Veiller à ce que le bouton en plastique rouge soit dans la position indiquée lorsqu'il est totalement serré.
- Répéter l'opération pour tous les pieds.



- Vérifier que la barre transversale est solidement fixée au véhicule.
- Utiliser les touches pour installer et verrouiller les couvercles

**ATTENTION : Vérifier régulièrement que les vis  
sont bien serrées**

---

## Maintenance

- Nettoyer le toit de la voiture et les surfaces des produits qui seront en contact avec le toit de la voiture.
- Suivre les instructions de montage pour l'installation du produit sur votre véhicule. S'assurer que toutes les étapes sont réalisées dans l'ordre.
- Placer les barres transversales à une distance minimale de 700 mm (27 1/2") lorsqu'aucune autre distance n'est indiquée dans les instructions de montage. Cela est particulièrement important pour le transport de charges longues.
- Placer les barres transversales à une distance minimale de 700 mm lorsqu'aucune autre distance n'est indiquée dans les instructions de montage. Cela est particulièrement important pour le transport de charges longues.
- Certains toits en verre/panoramiques et autres antennes radio peuvent ne plus être utilisés dès lors que le produit est fixé.
- Ne pas modifier ce produit.
- Se référer à la capacité de charge maximale autorisée dans les instructions de montage. Ne pas dépasser les fabricants de véhicules toit des avis si elle est inférieure à la capacité de charge maximale spécifiée dans les instructions de montage
- Les charges longues doivent être attachées avec des sangles non élastiques à l'avant et l'arrière du véhicule.
- Les objets à bouts pointus (skis) doivent être transportés avec les pointes tournées vers l'arrière du véhicule.
- Retirez tous les objets en vrac ou amovibles de la charge avant le chargement.
- S'assurer que toutes les charges sont solidement attachées avec des sangles non élastiques. Vérifier régulièrement pendant les longs trajets.
- Un système de galerie de toit chargé peut altérer les performances de votre véhicule. Soyez particulièrement conscients des effets de vents latéraux, le changement de direction, et du freinage. Évitez accélération et de décélération. Conduisez prudemment

- Noter que la hauteur totale du véhicule augmente lorsque les charges sont transportées en position verticale.
- Les produits doivent être verrouillés pendant le transport si ils sont équipés de serrures.
- Vérifier et remplacer les éléments usés ou défectueux
- Conserver le produit propre et en bon état.
- Ne jamais entrer dans un lave-auto avec le système de galerie de toit installé.
- Lubrifier les serrures et les vis de réglage à intervalles réguliers.
- Retirer le produit du véhicule lorsqu'il n'est pas utilisé. Veiller à ce que toutes les pièces détachées soient stockées en toute sécurité.

- 
- Yakima Products, Inc.  
15025 SW Koll Pkwy.  
Beaverton, OR 97006-6056  
USA

[www.whispbar.fr](http://www.whispbar.fr)  
[www.whispbar.ca/fr](http://www.whispbar.ca/fr)

---

## Montering første gang



- Pakk ut delene og kontroller innholdet. Kontakt din forhandler hvis deler mangler eller er skadet.

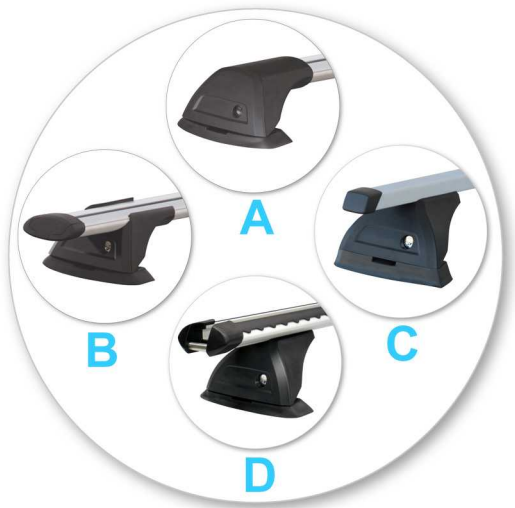

- Dette monteringssettet passer type A, B, C og D.
- Denne bruksanvisningen viser montering av stativ type A. den gjelder også for type B, C og D.



- Bruk nøklene for å ta av dekslene





- Bruk unbracoskrutrekker for å skru ut justeringsskruen 10 omdreininger.



- Trykk inn justeringsskruen og dra ut ftene på stativet. Bruk bruksanvisningen for riktig justering av stativet.
- Forsikre deg om at stativet er justert likt i hver ende i forhold til.

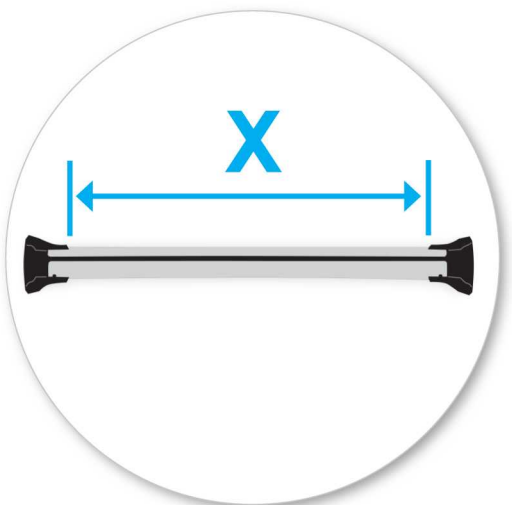

- Juster den inn eller ut så det passer til kjøretøyet. Instruksjonene for tverrstangen viser hvordan den skal justeres.
- Sørg for at tverrstangen justeres jevnt på begge sider.
- Vennligst les slutten av denne bruksanvisningen for informasjon som er spesifikk for din bil.



- Trekk til justeringskruen med et moment på 5Nm / 3.7 ft lb.

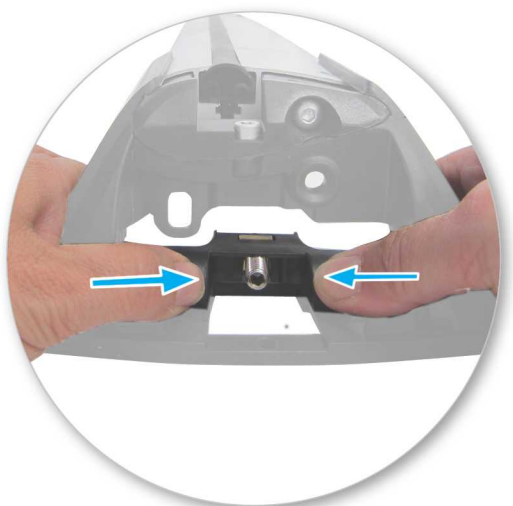

- Demonter brakettklossen ved å presse bakover.



- Velg plastblokk for bruk i foten (ligger med monteringssettet) og plasser i foten.
- Repeter for alle føtter.



- Monter gummifot (kommer med stativet) til foten.
- Forsikre om at gummifoten passer i hullene på foten på stativet.
- Repeter for alle føtter.

## Montering

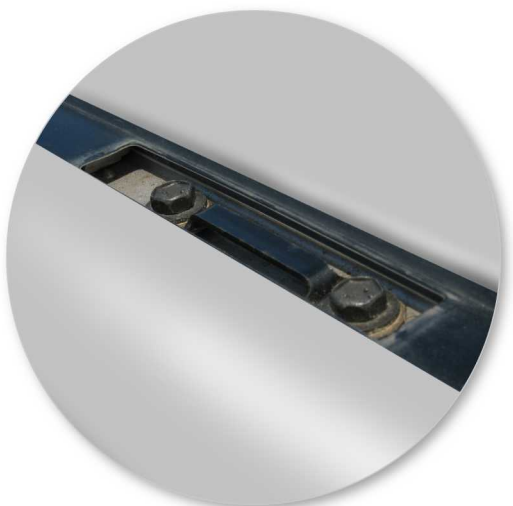

- Åpne eller fjern dekselet på fix point festet.
- Festepunktet kan variere i forhold til dem som er avbildet.



- Hekt klemmene inn i festepunktene på kjøretøyet.



- Pass på at den innvendige klemmen sitter vertikalt.
- Repeter for alle ender.



- Plasser grøftelistinnsatsen over klemmen.



- Monter tverrstengene over klemmene.



- Skru til den røde delen. Enden med mutteren skal være opp.



- Forsikre deg om at den røde delen er i posisjonen som vist på bildet når den skues til.
- Repeter for alle føtter.



- Forsikre om at takstativet er sikkert festet til bilen.
- Bruk nøkkelen og sett på dekslene

**Advarsel: undersøk regelmessig at skruer er festet og strammet korrekt.**

---

## Vedlikehold

- Rengjør grundig taket og alle overflater på produktet som kommer i kontakt med taket på bilen.
- Følg bruksanvisningen når du monterer produktet på bilen. Sørg for at trinn følges i rett rekkefølge.
- Avstanden mellom stengene skal være minimum 700 mm hvis noe annet ikke er spesifisert i bruksanvisningen. Dette er spesielt viktig der det skal transporteres lange gjenstander.
- Kontroller at takstativet er sikkert festet hver gang du monterer det på bilen. Hvis stativet føles løst bør bruksanvisningen følges og etterjuster.
- Enkelte soltak og antenner kan ikke være i bruk når takstativ er montert.
- Ikke modifier dette produktet.
- Se maksimalt tillatte lastekapasitet i bruksanvisningen. Man skal likevel aldri gå over anbefalt totalvekt for bilens tak.
- Lange gjenstander bør alltd festes med elastiske stropper både foran og bak på bilen.
- Gjenstander med spiss ende bør alltid fraktes med den spisse enden bakover.
- Fjern alle løse gjenstander fra lasten før den festes på taket.
- Forsikre deg om at all last er festet med ikke elastiske stropper og kontroller regelmessig under lange turer.
- Last på taket kan endre kjøregenskapene på bilen. Det er viktig å være oppmerksom på sidevind, unnamanøvre og bremseegenskaper. Kjør forsiktig.
- Vær oppmerksom på at høyden på bilen ofte øker betraktelig med last på taket.
- Produkter bør løses under transport hvis mulig.
- Kontroller og bytt ut slitte eller defekte deler.
- Hold produktet rent og vedlikeholdt.
- Kjør aldri inn i en bilvaskemaskin med takstativet på.
- Smør låsene og juster skruer hvis nødvendig med jevne intervaller.

- Demonter produktet hvis det ikke er bruk. Sørg for å lagre alle løse deler forsvarlig.
- 

- Yakima Products, Inc.  
15025 SW Koll Pkwy.  
Beaverton, OR 97006-6056  
USA

[www.whispbar.no](http://www.whispbar.no)

---



## Primeira instalação



- Retire as peças da embalagem e confirme o conteúdo. Contacte a sua loja no caso de faltarem peças ou na eventualidade de estarem danificadas.



- Este kit serve o tipo A, B, C e D.
- Estas instruções mostram a barra de tejadilho tipo A montada. Também se aplica ao tipo B, C e D.



- Utilize as chaves para retirar a tampa.



- Utilize a chave hexagonal para desapertar o parafuso de ajuste. 10 voltas.



- Pressione o parafuso de ajuste e puxe os pés da barras para fora. Consulte as Instruções de Montagem das barras de tejadilho para o ajuste da barra.
- Certifique-se que as extremidades da barra estão ajustadas de forma igual.

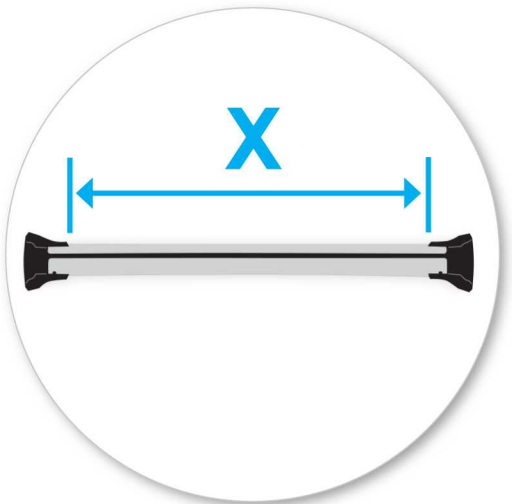

- Deslize a barra de tejadilho para dentro ou para fora de forma a ajustar-se ao veículo. Consulte as Instruções de Montagem das barras de tejadilho para o ajuste da barra.
- Certifique-se que a barra de tejadilho está ajustada de forma igual em cada extremidade.
- PF consulte o verso deste manual para informação específica relativa ao seu veículo.

- Aperte parafuso de ajuste a 5Nm / 3.7 ft lb.



- Retire a peça central segurando o pé da barra com os dedos e empurrando firmemente com os polegares a peça central até esta sair pelo interior do pé da barra.

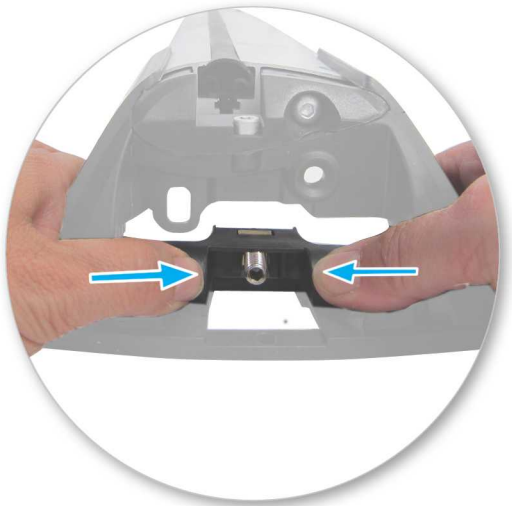

- Identifique a peça central de plástico (no Kit de Fixação) e introduza no interior do pé da barra.
- Repita operação para todos os pés das barras.





- Ajuste a almofada de borracha (fornecida com as barras) à base do pé da barra.
- Certifique-se que a almofada encaixa correctamente na base do pé da barra.
- Repita operação para todos os pés das barras.

## Montagem



- Abra ou retire as coberturas dos pontos de fixação no tejadilho do veículo.
- Os pontos de fixação podem diferir dos apresentados na figura.



- Engate os ganchos fornecidos nos pontos de fixação do veículo.



- Certifique que o gancho assenta correctamente.
- Repita operação para os quatro pontos de fixação do veículo.



- Coloque o molde sobre o gancho.



- Monte as barras de tejadilho sobre os ganchos.



- Aperte a rosca plástica vermelha. O lado com a porca visível deve estar virado para cima.



- Certifique-se que a rosca plástica de cor vermelha está na posição demonstrada quando totalmente apertada.
- Repita operação para todos os pés das barras.



- Certifique-se que a barra de tejadilho está fixa ao veículo de forma segura.
- Utilize as chaves para colocar e fechar as coberturas.

**ATENÇÃO: Verifique regularmente se os parafusos estão apertados.**

---

## Manutenção

- Limpe o tejadilho do carro e as superfícies do produto que estarão em contacto com o tejadilho.
- Siga as Instruções de Montagem para a colocação do produto no seu veículo. Certifique-se que todos os passos são seguidos correctamente.
- Coloque as barras de tejadilho a uma distância mínima de 700mm, quando não é especificada outra distância nas Instruções de Montagem. Especialmente importante ao transportar cargas longas.
- Sempre que voltar a colocar as barras no seu veículo, confirme se o conjunto formado pelas barras e respectivos pés continua montado de forma segura. Se perceber que tem folgas, consulte novamente as Instruções de Montagem e reajuste.
- Certos tectos de abrir e antenas de rádio não poderão ser utilizados aquando da colocação das barras de tejadilho.
- Não tente modificar este produto.
- Considere sempre a capacidade máxima de carga especificada nas Instruções de Montagem. Não exceda a capacidade de carga comunicada pelo fabricante do veículo quando esta é inferior à capacidade de carga especificada nas Instruções de Montagem.
- As cargas longas deverão ser seguras com cintas não elásticas na frente e na traseira do veículo.
- Objectos pontiagudos (ex. Skis) deverão ser transportados com a extremidade pontiaguda em direcção à traseira do automóvel.
- Retire todos os objectos soltos ou passíveis de se soltarem antes de iniciar o transporte.
- Certifique-se que toda a carga está presa de forma segura com cintas não elásticas. Verifique regularmente durante viagens longas.
- Transportar carga no tejadilho do veículo pode alterar o comportamento do mesmo. Tenha especial atenção para o efeito dos ventos laterais, mudanças de direcção e situações de travagem. Evite acelerações e desacelerações rápidas. Conduza com precaução.



- Note que a altura total do veículo aumenta quando são transportadas cargas verticais.
- Os acessórios devem estar trancados durante o transporte sempre que tiverem dispositivos anti-roubo.
- Verifique e substitua as peças desgastadas ou com defeito.
- Mantenha o produto limpo e com manutenção regular.
- Não lavar o carro em sistemas de lavagem automática com as barras de tejadilho montadas.
- Lubrifique os anti-roubos e os parafusos de ajuste periodicamente.
- Retire as barras de tejadilho do seu veículo quando não as utilizar. Salvaguarde que guarda todas as peças em local seguro.

- 
- Yakima Products, Inc.  
15025 SW Koll Pkwy.  
Beaverton, OR 97006-6056  
E.U.A

[www.whispbar.pt](http://www.whispbar.pt)  
[www.whispbar.br](http://www.whispbar.br)

---

## Первая Установка

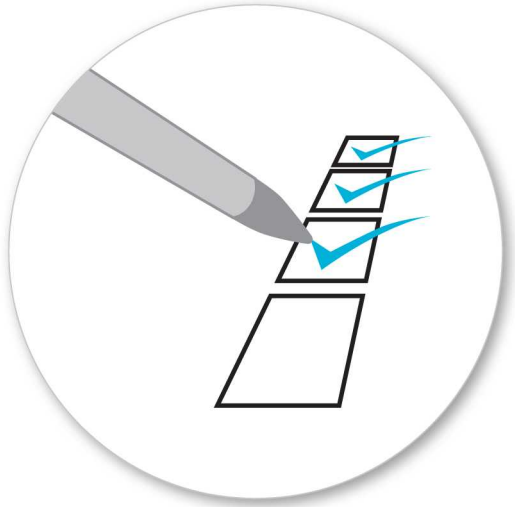

- Распакуйте установочный комплект и проверьте наличие всех компонентов. В случае отсутствия или повреждения каких либо компонентов обратитесь к вашему представителю Prorack

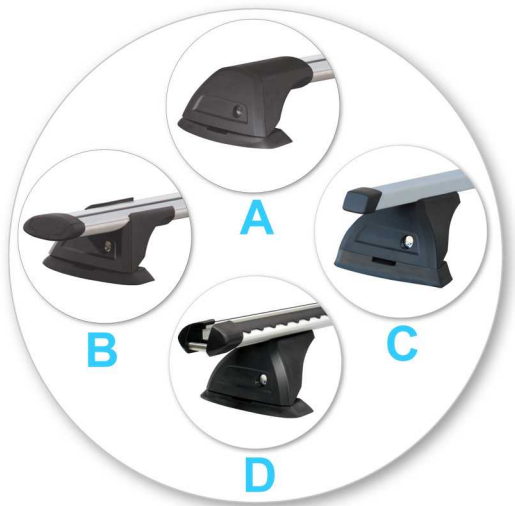

- Данный установочный набор подходит к типу А, В, С и D.
- Данные инструкции показывают установку поперечных балок типа А. Идентичные операции используются в установке балок типа В, С и D.



- Используйте ключи чтобы снять крышки багажника



- Используйте шестигранную отвертку чтобы открутить регулировочный винт. Около 10-ти оборотов.



- Держите регулировочный винт нажатым и потяните упоры поперечных балок на себя. Полное описание регулировки упоров описано в инструкции багажника.
- Постарайтесь отрегулировать упоры так чтобы они были расположены на одинаковом расстоянии от краёв балки.

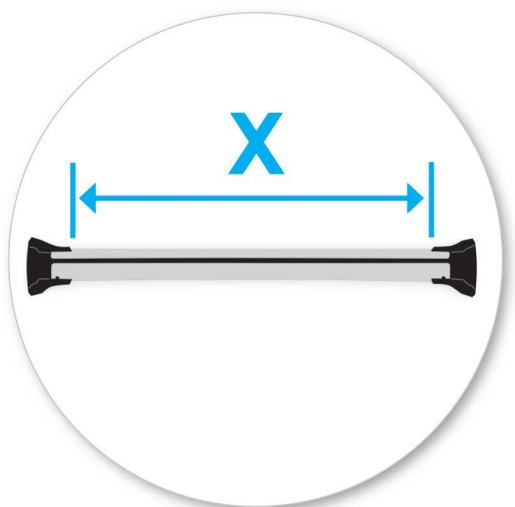

- Отрегулируйте упоры поперечных балок ближе или дальше друг от друга (в зависимости от ширины крыши вашего автомобиля). Регулировка упоров описана в инструкции поперечных балок
- Постарайтесь отрегулировать упоры так чтобы они были расположены на одинаковом расстоянии от каждого края поперечной балки
- Более подробную информацию, относящуюся к вашему типу автомобиля, можно найти на обороте данного руководства.



- Затяните регулировочный винт до 5Nm / 3.7 ft lb.

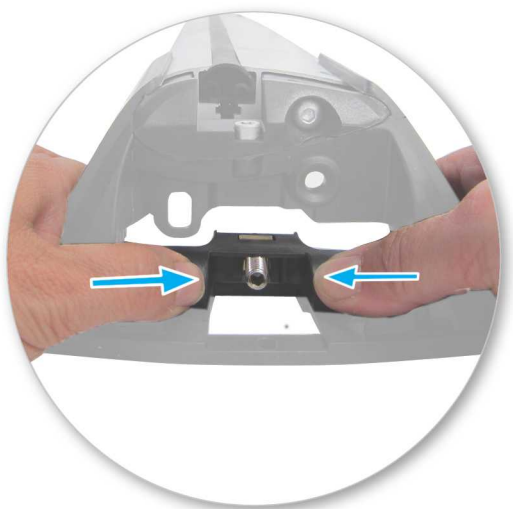

- Снимите пластиковый зажимной блок, обхватив ножки поперечины пальцами и с усилием нажимая большими пальцами на зажимной блок, пока он не выпадет с тыльной стороны ножек.



- Возьмите пластиковый внутренний блок и вставьте его в упор поперечной балки.
- Повторите на всех упорах.



- Установите резиновые подкладки (предоставленные с поперечными балками) на ножки упоров багажника.
- Убедитесь что резиновая подкладка полностью смыкается с ножкой упора багажника
- Повторите на всех упорах.

## Установка

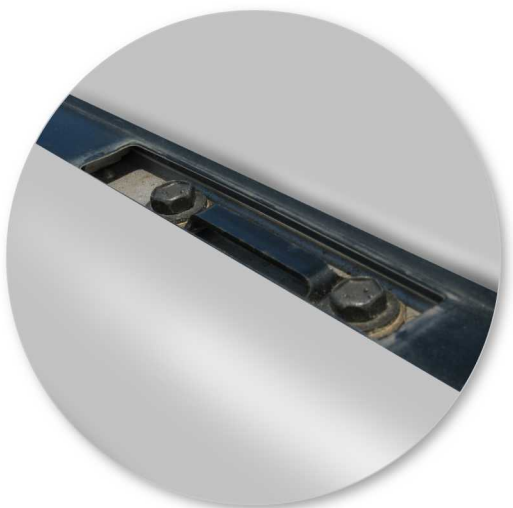

- Откройте или снимите крышки со штатных мест установки багажника на автомобиле.
- Внешний вид установочных крючков может отличаться от показанных на картинке



- Зацепите скобы за установочные крючки на автомобиле



- Убедитесь что скобы зацепленные за установочные крючки находятся в вертикальном положении
- Повторите на всех четырёх установочных местах



- Положите резиновые подкладки на скобы



- Установите поперечные балки на резиновые подкладки



- Плотно закрутите красную пластиковую регулировочную ручку. Деталь крепится гайкой наружу.



- Когда красная ручка затянута, она должна находиться в положении идентичном показанному на картинке
- Повторите на всех упорах.



- Проверьте, что багажник надежно установлен на автомобиле
- Используйте ключи чтобы установить и закрыть крышки багажника

**ВНИМАНИЕ! Регулярно проверяйте тугость  
ВИНТОВ**

---



## Эксплуатация

- Крыша автомобиля, а также все компоненты набора которые будут с ней соприкоснутся должны быть чистыми
- Следуйте инструкции при установке продукции на ваш автомобиль.
- Установите поперечные балки с минимальным промежутком 700мм (27 1/2") если в инструкциях не указаны специальные размеры для вашего автомобиля. Это поможет вам при перевозке длинных грузов.
- Если переустановив багажник вы считаете что он плохо прикреплен то обратитесь к инструкциям по установке и переустановите багажник заново.
- При установке данного изделия возможно Вы не сможете использовать некоторые виды стеклянных/панорамных крыш и радиоантенн.
- Не модифицируйте данный продукт!
- Максимальная допустимая нагрузка на ваш багажник обозначена в инструкциях установочного набора. Если производитель вашего автомобиля допускает меньшую нагрузку на крышу то следуйте ей.
- Длинные грузы должны быть закреплены неэластичными верёвками спереди и сзади автомобиля
- Остроконечные предметы (например лыжи) должны перевозиться с острыми концами направленными назад.
- Снимите все плохо закреплённые предметы с вещей которые вы собираетесь везти перед тем как погрузите их на багажник.
- Все перевозимые предметы должны быть крепко закреплены на багажнике неэластичными верёвками. Регулярно проверяйте тугость верёвок во время длинных поездок.
- Багажник с нагрузкой может повлиять на характеристики вашего автомобиля. Старайтесь вести ваш автомобиль аккуратно, не превышая скорость и избегая резких разгонов, торможений и поворотов.
- Помните что багажник с грузом влияет на высоту вашего автомобиля.

- Всё оборудование с установленными на нём замками должно быть закрыто во время поездки.
- Если вы заметили что какие либо из компонентов повреждены или износились, замените их как можно скорее.
- Старайтесь сохранять ваш багажник в чистом и ухоженном состоянии так как это увеличит срок службы продукта.
- Никогда не заезжайте в автоматическую автомойку с установленным багажником.
- Регулярно смазывайте замки и регулировочные винты.
- Снимите багажник с автомобиля когда вы его не используете. Храните все компоненты в безопасном месте.

- 
- Yakima Products, Inc.  
15025 SW Koll Pkwy.  
Beaverton, OR 97006-6056  
USA

[www.whispbar.ru](http://www.whispbar.ru)  
[www.whispbar.com.ua](http://www.whispbar.com.ua)

---

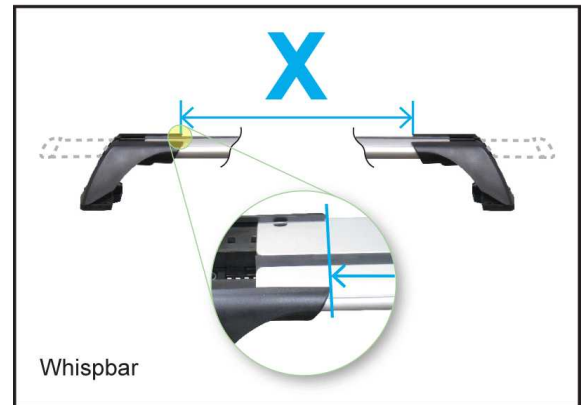
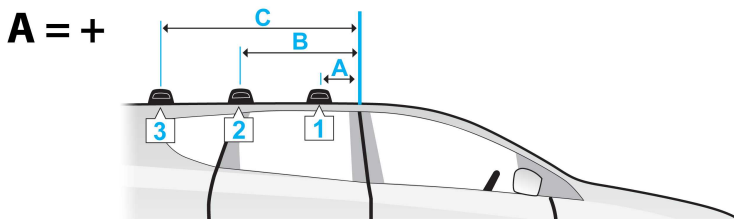
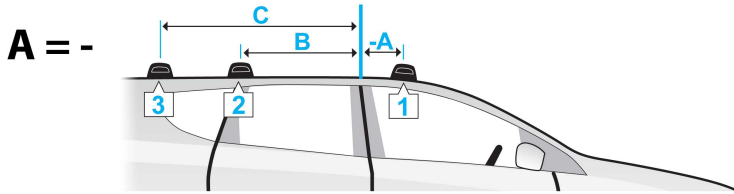

	<b>X</b>					
	<b>A</b>	<b>B</b>	<b>C</b>	<b>1</b>	<b>2</b>	<b>3</b>
Land Cruiser Prado, 5dr SUV 03-09 (EU)	-	850mm	1340mm	920mm	864mm	841mm
	-	33 7/16ths"	52 3/4ths"	36 1/4ths"	34"	33 1/8ths"
Land Cruiser Prado, 5dr SUV Dec 09-+ (NZ)	20mm	830mm	1310mm	935mm	895mm	875mm
	0 13/16ths"	32 11/16ths"	51 9/16ths"	36 13/16ths"	35 1/4ths"	34 7/16ths"
Land Cruiser Prado, 5dr SUV Mar 03-Nov 09 (NZ)	-	850mm	1340mm	920mm	864mm	841mm
	-	33 7/16ths"	52 3/4ths"	36 1/4ths"	34"	33 1/8ths"
Land Cruiser Prado, 5dr SUV Mar 03-Oct 09 (AU)	-	850mm	1340mm	920mm	864mm	841mm
	-	33 7/16ths"	52 3/4ths"	36 1/4ths"	34"	33 1/8ths"
Land Cruiser Prado, 5dr SUV Nov 09-+ (AU)	20mm	830mm	1310mm	935mm	895mm	875mm
	0 13/16ths"	32 11/16ths"	51 9/16ths"	36 13/16ths"	35 1/4ths"	34 7/16ths"
Land Cruiser, 5dr SUV 07-+ (US)	280mm	940mm	1600mm	983mm	954mm	935mm
	11"	37"	63"	38 11/16ths"	37 9/16ths"	36 13/16ths"
Land Cruiser, 5dr SUV 07-+ (EU)	280mm	940mm	1600mm	983mm	954mm	935mm
	11"	37"	63"	38 11/16ths"	37 9/16ths"	36 13/16ths"
Land Cruiser, 5dr SUV 98-07 (EU)	150mm	820mm	1540mm	1040mm	1010mm	980mm
	5 7/8ths"	32 5/16ths"	60 5/8ths"	40 15/16ths"	39 3/4ths"	38 9/16ths"
Land Cruiser, 5dr SUV 98-07 (US)	150mm	820mm	1540mm	1040mm	1010mm	980mm
	5 7/8ths"	32 5/16ths"	60 5/8ths"	40 15/16ths"	39 3/4ths"	38 9/16ths"
Land Cruiser, 5dr SUV 98-07 (ZA)	150mm	820mm	1540mm	1040mm	1010mm	980mm
	5 7/8ths"	32 5/16ths"	60 5/8ths"	40 15/16ths"	39 3/4ths"	38 9/16ths"
Land Cruiser, 5dr SUV Apr 98-Jun 07 (AU)	150mm	820mm	1540mm	1040mm	1010mm	980mm
	5 7/8ths"	32 5/16ths"	60 5/8ths"	40 15/16ths"	39 3/4ths"	38 9/16ths"
Land Cruiser, 5dr SUV Apr 98-Oct 07 (NZ)	150mm	820mm	1540mm	1040mm	1010mm	980mm
	5 7/8ths"	32 5/16ths"	60 5/8ths"	40 15/16ths"	39 3/4ths"	38 9/16ths"
Land Cruiser, 5dr SUV Aug 07-+ (AU)	280mm	940mm	1600mm	983mm	954mm	935mm
	11"	37"	63"	38 11/16ths"	37 9/16ths"	36 13/16ths"
Land Cruiser, 5dr SUV Nov 07-+ (NZ)	280mm	940mm	1600mm	983mm	954mm	935mm
	11"	37"	63"	38 11/16ths"	37 9/16ths"	36 13/16ths"
LX470, 5dr SUV Apr 98-Jul 07 (AU)	150mm	820mm	1540mm	1040mm	1010mm	980mm
	5 7/8ths"	32 5/16ths"	60 5/8ths"	40 15/16ths"	39 3/4ths"	38 9/16ths"

LX470, 5dr SUV May 98-Oct 07 (NZ)	150mm 5 7/8ths"	820mm 32 5/16ths"	1540mm 60 5/8ths"	1040mm 40 15/16ths"	1010mm 39 3/4ths"	980mm 38 9/16ths"
Rav 4, 3dr SUV 00-05 (ZA)	-440mm -17 -5/16ths"	230mm 9 1/16ths"	510mm 20 1/16ths"	- -	- -	- -
Rav 4, 3dr SUV 00-05 (ZA)	-440mm -17 -5/16ths"	230mm 9 1/16ths"	510mm 20 1/16ths"	862mm 33 15/16ths"	808mm 31 13/16ths"	790mm 31 1/8ths"
Rav 4, 3dr SUV 00-06 (EU)	-440mm -17 -5/16ths"	230mm 9 1/16ths"	510mm 20 1/16ths"	- -	- -	- -
Rav 4, 3dr SUV 00-06 (EU)	-440mm -17 -5/16ths"	230mm 9 1/16ths"	510mm 20 1/16ths"	862mm 33 15/16ths"	808mm 31 13/16ths"	790mm 31 1/8ths"
Rav 4, 3dr SUV 94-00 (US)	- -	- -	- -	- -	- -	- -
Rav 4, 3dr SUV 94-00 (EU)	- -	- -	- -	- -	- -	- -
Rav 4, 3dr SUV 94-99 (ZA)	- -	- -	- -	- -	- -	- -
Rav 4, 3dr SUV Jun 00-Jan 06 (NZ)	-440mm -17 -5/16ths"	230mm 9 1/16ths"	510mm 20 1/16ths"	- -	- -	- -
Rav 4, 3dr SUV Jun 00-Jan 06 (NZ)	-440mm -17 -5/16ths"	230mm 9 1/16ths"	510mm 20 1/16ths"	862mm 33 15/16ths"	808mm 31 13/16ths"	790mm 31 1/8ths"
Rav 4, 3dr SUV Jun 00-Jan 06 (AU)	-440mm -17 -5/16ths"	230mm 9 1/16ths"	510mm 20 1/16ths"	- -	- -	- -
Rav 4, 3dr SUV Jun 00-Jan 06 (AU)	-440mm -17 -5/16ths"	230mm 9 1/16ths"	510mm 20 1/16ths"	862mm 33 15/16ths"	808mm 31 13/16ths"	790mm 31 1/8ths"
Rav 4, 3dr SUV Jun 94-May 00 (AU)	- -	- -	- -	- -	- -	- -
Rav 4, 3dr SUV Jun 94-May 00 (NZ)	- -	- -	- -	- -	- -	- -
Rav 4, 5dr SUV 00-04 (EU)	-100mm -3 -15/16ths"	550mm 21 5/8ths"	1120mm 44 1/8ths"	854mm 33 5/8ths"	806mm 31 3/4ths"	792mm 31 3/16ths"
Rav 4, 5dr SUV 00-06 (ZA)	-100mm -3 -15/16ths"	550mm 21 5/8ths"	1120mm 44 1/8ths"	854mm 33 5/8ths"	806mm 31 3/4ths"	792mm 31 3/16ths"
Rav 4, 5dr SUV 94-00 (EU)	220mm 8 11/16ths"	830mm 32 11/16ths"	- -	745mm 29 5/16ths"	735mm 28 15/16ths"	- -
Rav 4, 5dr SUV 94-99 (ZA)	220mm 8 11/16ths"	830mm 32 11/16ths"	- -	745mm 29 5/16ths"	735mm 28 15/16ths"	- -
Rav 4, 5dr SUV Dec 94-May 00 (NZ)	220mm 8 11/16ths"	830mm 32 11/16ths"	- -	745mm 29 5/16ths"	735mm 28 15/16ths"	- -
Rav 4, 5dr SUV Jul 95-May 00 (AU)	220mm 8 11/16ths"	830mm 32 11/16ths"	- -	745mm 29 5/16ths"	735mm 28 15/16ths"	- -
Rav 4, 5dr SUV Jun 00-Jan 06 (NZ)	-100mm -3 -15/16ths"	550mm 21 5/8ths"	1120mm 44 1/8ths"	854mm 33 5/8ths"	806mm 31 3/4ths"	792mm 31 3/16ths"
Rav 4, 5dr SUV Jun 00-Jan 06 (AU)	-100mm -3 -15/16ths"	550mm 21 5/8ths"	1120mm 44 1/8ths"	854mm 33 5/8ths"	806mm 31 3/4ths"	792mm 31 3/16ths"
SX4, 5dr Hatch 06+ (EU)	-120mm -4 -3/4ths"	600mm 23 5/8ths"	- -	759mm 29 7/8ths"	723mm 28 7/16ths"	- -
SX4, 5dr Hatch 06+ (ZA)	-120mm -4 -3/4ths"	600mm 23 5/8ths"	- -	759mm 29 7/8ths"	723mm 28 7/16ths"	- -
SX4, 5dr Hatch 07+ (US)	-120mm -4 -3/4ths"	600mm 23 5/8ths"	- -	759mm 29 7/8ths"	723mm 28 7/16ths"	- -
SX4, 5dr Hatch Mar 07+ (NZ)	-120mm -4 -3/4ths"	600mm 23 5/8ths"	- -	759mm 29 7/8ths"	723mm 28 7/16ths"	- -
SX4, 5dr Hatch Mar 07+ (AU)	-120mm -4 -3/4ths"	600mm 23 5/8ths"	- -	759mm 29 7/8ths"	723mm 28 7/16ths"	- -

**LIMITED LIFETIME WARRANTY**

Technical Assistance or Replacement Parts: Contact your dealer or visit: [www.whispbar.com](http://www.whispbar.com) or call (888) 925-4621 Monday through Friday, 7:00am to 5:00pm, PST

This limited lifetime warranty covers all Whispbar-brand products\* and rack components manufactured by Yakima Products, Inc. (Yakima), and is effective for as long as the original retail purchaser owns the product. This warranty terminates when the original retail purchaser sells or otherwise transfers the product to any other person. Subject to Yakima's inspection of the product, Yakima will remedy defects in materials and/or workmanship by repairing or replacing, at Yakima's option, the defective product without charge for parts or labor, subject to the limitations and exclusions described in this warranty. Yakima may elect, at its option, not to repair or replace a defective product, in which case Yakima will issue to the original retail purchaser, at Yakima's option, either a refund equal to the purchase price paid for the product, or a credit to be used toward the purchase of new Whispbar products or rack components. This warranty does not cover problems caused by normal wear and tear (including, but not limited to, scratches, dents, or aesthetic oxidation of surfaces), accidents, unlawful vehicle operation, or modifications or repairs not performed or authorized by Yakima. In addition, this warranty does not cover problems resulting from conditions beyond Yakima's control including, but not limited to, theft, misuse, overloading, or failure to assemble, mount or use the product in accordance with Yakima's written instructions or guidelines included with the product or made available to the original retail purchaser. If a product is believed to be defective, the original retail purchaser should contact the Whispbar dealer from whom it purchased the product, who will give the original retail purchaser instructions on how to proceed. If the original retail purchaser is unable to contact the Whispbar dealer, or the dealer is not able to remedy the defect, the original retail purchaser should contact Yakima by e-mail at: [yakwarranty@yakima.com](mailto:yakwarranty@yakima.com), or phone 888.925.4621 for shipping instructions. Upon contacting Yakima directly, a Yakima technician will provide the original retail purchaser with appropriate instructions for returning the product to Yakima. The original retail purchaser will be responsible for the cost of mailing the product to Yakima. In order to receive any remedy under this warranty (either from a Whispbar dealer, or from Yakima directly), proof of purchase in the form of an original purchase invoice or receipt is strictly required.

**LIMITATION OF LIABILITY**

REPAIR OR REPLACEMENT OF A DEFECTIVE PRODUCT, OR THE ISSUANCE OF A REFUND OR CREDIT (AS DETERMINED BY YAKIMA), IS THE ORIGINAL RETAIL PURCHASER'S EXCLUSIVE REMEDY UNDER THIS WARRANTY. DAMAGE OR INJURY TO THE ORIGINAL RETAIL PURCHASER, TO HIS OR HER VEHICLE, CARGO, OR PROPERTY, AND/OR TO ANY OTHER PERSON OR PROPERTY IS NOT COVERED BY THIS WARRANTY. THIS WARRANTY IS EXPRESSLY MADE IN LIEU OF ANY AND ALL OTHER EXPRESS WARRANTIES, WHETHER ORAL OR WRITTEN.

YAKIMA'S SOLE LIABILITY IS LIMITED TO THE REMEDY SET FORTH ABOVE. IN NO EVENT WILL YAKIMA BE LIABLE FOR ANY DIRECT, INDIRECT, CONSEQUENTIAL, INCIDENTAL, SPECIAL, EXEMPLARY, OR PUNITIVE DAMAGES OR FOR ANY OTHER DAMAGES OF ANY KIND OR NATURE (INCLUDING, BUT NOT LIMITED TO, LOST PROFITS OR LOST SALES).

SOME STATES DO NOT ALLOW THE EXCLUSION OR LIMITATION OF INCIDENTAL OR CONSEQUENTIAL DAMAGES, SO THE ABOVE LIMITATIONS MAY NOT APPLY TO YOU.

THIS WARRANTY GIVES YOU SPECIFIC LEGAL RIGHTS, AND YOU MAY ALSO HAVE OTHER RIGHTS WHICH VARY FROM STATE TO STATE.

**WARRANTY & DISCLAIMER**

**Yakima Australia Pty Ltd ABN 58 154 440 221**  
**17 Hinkler Court, Brendale QLD 4500**  
**Tel: 0800 4776 722 (NZ) or 1800 143 548 (AU)**  
**Email: warranty@yakima.co.nz or warranty@yakima.com.au**

1. Where the product is supplied to the customer for other than business purposes within the meaning of section 43 of the New Zealand Consumer Guarantees Act 1993, the provisions of that Act shall apply. It is important that anyone who fits or uses this product does so in accordance with the manufacturer's instructions.
2. Where the product is supplied to the customer for business purposes within the meaning of section 43 of the New Zealand Consumer Guarantees Act 1993, the provisions of that Act and all other representations or terms (including any conditions or warranty expressed or implied by law, statute or otherwise) not expressly included in this leaflet are hereby expressly excluded shall have no effect and the clauses (a) and (b) shall apply.
3. Subject to the **Additional Information (Australia)**, where the product is supplied and purchased in Australia, the following shall apply:
  - a. THE SUPPLIER WARRANTS the product to be free from defects in materials and/or workmanship for a limited lifetime from the date of original purchase (the warranty period). Proof of purchase is required. Subject to the limitations and exclusions set out below, the Supplier hereby agrees to remedy any defects in materials or workmanship becoming apparent during the warranty period, by replacing or repairing any defective product or component (at its option) free of charge to the purchaser in respect of replacement parts or labour. Any defective product or component must be notified and where practicable, returned at the purchaser's expense to the Supplier immediately upon discovery of the alleged defect and no attempt made on the part of the purchaser to repair it.
  - b. EXCEPTIONS, EXCLUSIONS AND LIMITATIONS TO WARRANTY. The product and/or its components must be fitted/ assembled and loaded in accordance with the Supplier's written instructions and any requirements set out in the car's owner manual. This warranty does not cover defects, loss or damage resulting from circumstances beyond the Supplier's control including, but not limited to misuse, overloading, or failure to assemble and/or fit the product or component in accordance with the Supplier's written instructions. Nor does the warranty cover defects, loss or damage resulting from accidents, unlawful use of the vehicle or defects/inconsistencies in the vehicle on which the product or component is fitted. Liability for direct, indirect, special, punitive, incidental, exemplary, contractual or consequential damage or loss arising from defects, faulty materials or design omissions or negligence or workmanship in the product or its components is hereby expressly excluded subject to the following. Certain Commonwealth legislation, including the Competition and Consumer Act 2010 (Cth), and other State and Territorial legislation confers upon purchasers rights which cannot be excluded from or be restricted or modified by contract. Any conditions, guarantees and/or warranties implied by law and incapable of exclusion are deemed to be expressly incorporated herein. Nothing herein contained is intended nor shall be permitted to be inconsistent with any such conditions, guarantees and/or warranties. To the extent permitted by legislation all conditions, guarantees and/or warranties such as implied warranties which are capable of exclusion are hereby expressly excluded and negated.

**ADDITIONAL INFORMATION ( AUSTRALIA )**

This information should be read in conjunction with clauses (a) and (b).

**IMPORTANT LEGAL NOTICE**

Our goods come with guarantees that cannot be excluded under the Australian Consumer Law. You are entitled to a replacement or refund for a major failure and for compensation for any other reasonably foreseeable loss or damage. You are also entitled to have the goods repaired or replaced if the goods fail to be of acceptable quality and the failure does not amount to a major failure.

This warranty does not change or take away your rights under the Australian Consumer Law. Your right to claim under this policy for the benefits covered is in addition to other rights and remedies you have under the law in relation to the product.

Where you become aware of defects in materials or of workmanship, and wish to make a claim under this warranty you must do the following for the warranty to be honoured by your Whispbar dealer or Yakima Australia Pty Ltd ABN 58 154 440 221 (Yakima):

1. Make a claim as soon as practicable by contacting the Whispbar dealer from whom you purchased the product, who will give you instructions on how to proceed.
2. If you are unable to contact the Whispbar dealer, or the dealer is not able to remedy the defect, you should contact Yakima as soon as practicable at:  
 Call: 0800 4776 722 (NZ) or 1800 143 548 (AU)  
 Email: warranty@yakima.co.nz or warranty@yakima.com.au

Alternately, you can write to Yakima at 17 Hinkler Court, Brendale QLD Australia 4500 in order to make a claim under your warranty.

3. Upon contacting Yakima directly, you should explain as fully as possible the defect. A Yakima representative will provide you with appropriate instructions for returning the product together with a copy of the original purchase invoice or receipt to Yakima.

4. The costs and expenses associated with making a claim under your warranty including the costs of complying with those instructions and of returning the product to Yakima or the Whispbar dealer will be borne by you.

Following receipt of the product and purchase invoice or receipt, Yakima or the Whispbar dealer must inspect the product to determine whether the claim falls within the warranty. If:

- 4.1 the claim falls within the warranty, Yakima will remedy any defects in materials or workmanship becoming apparent during the warranty period, by replacing or repairing any defective product or component (at its option) free of charge to the purchaser in respect of replacement parts or labour.
- 4.2 the claim does not fall within the warranty, Yakima will return the product to you at your expense.

## Whispbar 5-Jahres-Garantie (EU)

Whispbar ist stolz darauf, dass alle Produkte des Unternehmens nach höchsten Qualitätsstandards entwickelt, getestet und hergestellt werden. Zusätzlich verfügen alle in Europa verkauften Whispbar-Produkte über eine 5-Jahres-Garantie auf Material und Verarbeitung.

### I. Von der Garantie umfasste Waren und Garantierahmen

Whispbar gewährt für Lastträgersysteme, Dachboxen und Zubehör, die/das von Whispbar hergestellt und unter dem Markennamen Whispbar verkauft wurde/n, bei Materialdefekten und Verarbeitungsfehlern eine Garantie mit einer Laufzeit von bis zu fünf Jahren ab Lieferdatum.

Außer bei den nachfolgend genannten Einschränkungen und Ausnahmen behebt Whispbar Materialdefekte oder Verarbeitungsfehler während der Garantiezeit durch Reparatur oder Austausch der defekten Teile (nach Whispbars Ermessen), ohne dass dem Erstkäufer Kosten für Teile oder Arbeit entstehen. Der Erstkäufer ist für die Kosten des Versands der entsprechenden Teile/Produkte an den Original-Whispbar-Händler verantwortlich. Damit die Mängelbeseitigung im Rahmen dieser Garantie berücksichtigt werden kann, muss ein Kaufbeleg in Form der Originalrechnung vorgelegt werden.

### II. Übertragung der Garantie

Die Garantie gilt nur für den Erstkäufer der Ersatzteile und ist nicht übertragbar.

### III. Einschränkung der Garantierechte

Eine Garantie gilt nicht für Defekte durch Umstände, die außerhalb der Kontrolle von Whispbar liegen, einschließlich, aber nicht beschränkt auf normale Abnutzung, fehlerhaften Gebrauch, Überladung, Modifizierungen oder Reparaturen, die nicht von Whispbar ausgeführt oder autorisiert wurden, oder die durch fehlerhafte Montage, falschen Zusammenbau oder fehlerhafte Nutzung des Lastenträgers oder des Zubehörs entgegen den Anweisungen in den schriftlichen Bedienungsanleitungen und Sicherheitsbestimmungen von Whispbar entstanden sind.

Weiterhin wird keine Garantie gewährt für Defekte durch Unfälle, illegale Fahrzeugbewegung oder für Defekte am Fahrzeug, auf dem das Produkt installiert ist.

Eine Garantie für Defekte aufgrund fehlerhaften Verhaltens des Nutzers bei der Lastensicherung gemäß den Empfehlungen von Whispbar wird ebenfalls nicht gewährt.

Die Reparatur oder der Austausch fehlerhafter Whispbar-Produkte im Rahmen der Garantie ist allein dem Erstkäufer vorbehalten. Folge- oder Unfallschäden sind von der Garantie ausgenommen. Schäden am Fahrzeug oder Beförderungsgut des Nutzers sowie an anderen Personen oder Gütern sind von der Garantie ausgenommen.

### IV. Davon unberührte gesetzliche Mängelansprüche

Die oben aufgeführten Bestimmungen beeinträchtigen weder die gesetzlichen Rechte des Käufers oder Dritter bezüglich geltender nationaler Gesetze, noch die sich für den Käufer aus dem Kaufvertrag ergebenden Rechte gegenüber dem Verkäufer. Dies gilt insbesondere für Gewährleistungsrechte nach den geltenden nationalen Gesetzen, die in vollem Umfang weiterbestehen, unabhängig davon, ob ein Garantiefall eintritt und die Garantie in Anspruch genommen wird.

### V. Kontaktaufnahme mit Whispbar

Bei allen speziellen Fragen zur Garantie von Whispbar setzen Sie sich bitte mit dem nächsten Whispbar-Händler oder mit dem Händler in Verbindung, bei dem das Produkt gekauft wurde. Informationen über entsprechende Händler finden Sie auf [www.whispbar.eu](http://www.whispbar.eu)

Garantiegeber ist Yakima Products, Inc., 15025 SW Koll Parkway, Beaverton, OR 97006 USA

Whispbar ist eine registrierte Handelsmarke von Yakima Products, Inc.



## GARANTÍA LIMITADA DE POR VIDA

### SI NECESITA ASISTENCIA TÉCNICA O REPUESTOS

Contacte un vendedor, visite el sitio [www.whispbar.com](http://www.whispbar.com) o llame al (888)925-4621 De lunes a viernes, 7:00 AM a 5:00 PM, hora del Pacífico

Esta garantía limitada de por vida cubre todos los productos y accesorios de marca Whispbar, fabricados por Yakima Products, Inc. (Yakima), y es válida durante todo el tiempo que el comprador original conserve el producto. La validez de esta garantía caducará cuando el comprador original venda o transfiera el producto a otra persona. Sujeto a inspección y a las limitaciones y exclusiones descritas en esta garantía, Yakima reparará o sustituirá, a su criterio, el producto que presente defectos de material o mano de obra sin cargo por las piezas o la mano de obra. Yakima podrá elegir, según lo estime conveniente, no reparar o reemplazar un producto defectuoso. En tal caso, Yakima otorgará al comprador original, a su criterio, un reembolso o un vale igual al precio de compra para ser usado en la compra de nuevos productos o componentes de rejillas portaequipajes Whispbar. Esta garantía no cubre problemas causados por uso o desgaste normal del producto (incluyendo, sin limitarse a ello, arañazos, abolladuras, u oxidaciones que afecten solo a la estética de las superficies), accidentes, conducción ilegal de vehículos, reparaciones o modificaciones no realizadas o autorizadas por Yakima. Asimismo, esta garantía no cubre problemas derivados de circunstancias fuera del alcance de Yakima incluyendo, sin limitarse a ello, robo, mal uso, sobrecarga, o la colocación, montaje o uso del producto que no respeten las instrucciones por escrito de Yakima, incluidas en el producto o puestas a disposición del comprador original. Si el comprador original considera que un producto tiene algún defecto, puede comunicarse con el distribuidor de productos Whispbar donde adquirió el producto, que le dará las instrucciones necesarias sobre cómo proceder en este caso. Si no es posible comunicarse con el concesionario de Whispbar, o este no puede reparar el defecto, el comprador original deberá comunicarse con Yakima mediante el correo electrónico [yakwarranty@yakima.com](mailto:yakwarranty@yakima.com), o bien llamar por teléfono al número 888 925 4621 para que le indiquen las instrucciones de envío. Al comunicarse directamente con Yakima, un técnico de Yakima dará al comprador original las instrucciones apropiadas para devolver el producto a Yakima. El comprador original correrá con los gastos de envío. Para recibir cualquier servicio de reparación bajo esta garantía (tanto del distribuidor de los productos Whispbar como directamente de Yakima) se exigirá sin excepción la factura o el recibo original.

### LIMITACIÓN DE LA RESPONSABILIDAD

LA REPARACIÓN O SUSTITUCIÓN DEL PRODUCTO DEFECTUOSO O LA EMISIÓN DE UN REEMBOLSO O UN VALE (SEGÚN LO DETERMINE YAKIMA), CONSTITUYEN EL REMEDIO EXCLUSIVO PARA EL COMPRADOR ORIGINAL EN VIRTUD DE ESTA GARANTÍA. LOS DAÑOS O LESIONES OCASIONADOS AL COMPRADOR ORIGINAL, A SU VEHÍCULO, CARGA O PROPIEDAD O A CUALQUIER PERSONA O PROPIEDAD NO ESTÁN CUBIERTOS POR ESTA GARANTÍA. ESTA GARANTÍA ESTÁ CONCEBIDA EXPRESAMENTE PARA REEMPLAZAR AL RESTO DE GARANTÍAS, SEAN ORALES O ESCRITAS. LA RESPONSABILIDAD DE YAKIMA SE LIMITA AL REMEDIO MENCIONADO ANTERIORMENTE. EN NINGÚN CASO, YAKIMA SERÁ RESPONSABLE DE DAÑO ALGUNO DIRECTO, INDIRECTO, INCIDENTAL, ESPECIAL, PUNITIVO U OTROS DAÑOS DE CUALQUIER NATURALEZA (INCLUYENDO, SIN LIMITARSE A ELLO, GANANCIAS O VENTAS NO REALIZADAS).

## Garantía Whispbar de 5 años (UE)

En Whispbar estamos orgullosos de garantizar que todos nuestros productos son diseñados, probados y fabricados de acuerdo con las normas de calidad más exigentes. Además, todos los productos Whispbar vendidos en la UE disponen de una garantía de 5 años para los materiales y la mano de obra.

### I. Artículos cubiertos y ámbito de aplicación

Whispbar garantizará que los sistemas de transporte de cargas, cofres de techo y accesorios, fabricados por Whispbar y vendidos bajo la denominación comercial Whispbar, estén exentos de defectos en los materiales o la mano de obra durante cinco años a partir de la fecha de entrega del producto al comprador minorista original.

Con sujeción a las limitaciones y exclusiones que se exponen abajo, Whispbar remediará los defectos del material o de la mano de obra durante el período de garantía, reparando o sustituyendo (a discreción de Whispbar) los componentes defectuosos sin cargo en concepto de piezas o mano de obra para el comprador minorista original, que correrá con el coste de devolver los componentes/productos al distribuidor Whispbar original. Con el fin de que cualquier reparación se considere cubierta por esta garantía, será estrictamente necesario aportar una prueba de compra en forma de factura o recibo de compra original.

### II. Transferencia de la garantía

La garantía se emite solo para el comprador minorista original y no es transferible.

### III. Limitación de las reclamaciones de garantía

No se ofrece garantía alguna ante los defectos resultantes de condiciones ajenas al control de Whispbar incluyendo, sin limitarse a ello, uso o desgaste natural, mala utilización, sobrecarga, modificaciones o reparaciones no realizadas ni autorizadas por Whispbar, o debidas a un fallo de montaje, colocación o uso del portacargas o los accesorios de acuerdo con las instrucciones, directrices y texto de seguridad escritos de Whispbar.

Además, no se ofrece garantía alguna por los defectos causados por accidentes, uso ilegal del vehículo o defectos en el vehículo en el que se instala el producto.

Asimismo, no se ofrece garantía alguna por los defectos causados por el fallo de los usuarios a la hora de asegurar adecuadamente la carga de acuerdo con las recomendaciones de Whispbar.

La reparación o sustitución del producto Whispbar defectuoso es el único remedio que obtendrá el comprador original en virtud de la garantía. Todos los daños resultantes o fortuitos quedan excluidos de esta garantía. Los daños sufridos en el vehículo del usuario o en la carga así como por cualquier otra persona o propiedad quedan excluidos.

### IV. Reclamaciones legales no afectadas por las limitaciones

Las disposiciones anteriores no restringen los derechos legales del comprador ni de terceros en virtud de la legislación nacional aplicable. Tampoco afectan a los derechos del comprador ante el distribuidor derivados del contrato de compra formalizado entre las dos partes. Concretamente, esto se aplicará a los derechos de garantía de acuerdo con la legislación nacional aplicable que esté vigente, exceptuando el hecho de que se produzca un caso de garantía y de que la garantía se reclame o no.

### V. Contacto con Whispbar

Si tiene cualquier duda concreta acerca de la garantía Whispbar, póngase en contacto con el distribuidor Whispbar más cercano o con el distribuidor donde adquirió el producto. Puede encontrar información sobre los distribuidores en [www.whispbar.eu](http://www.whispbar.eu)  
El garante es Yakima Products, Inc., 15025 SW Koll Parkway, Beaverton, OR 97006 EE. UU.

Whispbar es una marca registrada de Yakima Products, Inc.

## GARANTIE LIMITÉE À VIE

POUR OBTENIR DES RENSEIGNEMENTS TECHNIQUES OU DES PIÈCES DE RECHANGE prière de contacter votre dépositaire, de consulter le site [www.whispbar.com](http://www.whispbar.com) ou d'appeler au (888) 925-4621, du lundi au vendredi, entre 7 heures et 17 heures, heure du Pacifique.

Cette garantie limitée à vie couvre tous les produits de la marque Whispbar\* et tous les composants du porte-vélo fabriqué par Yakima Products, Inc. (Yakima), et restera en vigueur aussi longtemps que l'acheteur au détail original sera en possession du produit. Cette garantie prendra fin lorsque l'acheteur au détail original vendra ou transférera le produit à toute autre personne. Sous réserve de l'inspection du produit par Yakima, Yakima remédiera aux défauts des matériaux et / ou de fabrication en réparant ou en remplaçant, à la discrétion de Yakima, tout produit défectueux sans frais de pièces ou de main d'oeuvre, sous réserve des limitations et des exclusions décrites dans cette garantie. Yakima peut décider, à sa discrétion, de ne pas réparer ou de ne pas remplacer un produit défectueux, auquel cas Yakima délivrera à l'acheteur au détail original, à la discrétion de Yakima, soit un remboursement égal au prix d'achat payé pour le produit, soit un avoir à utiliser pour l'achat de nouveaux produits ou de nouveaux composants du porte-vélo Whispbar. Cette garantie ne couvre pas les problèmes causés par l'usure normale (y compris, entre autres, les égratignures, les enfoncements, ou l'oxydation esthétique des surfaces), les accidents, la conduite illégale du véhicule, ou les modifications ou les réparations non effectuées ou non autorisées par Yakima. En outre, cette garantie ne couvre pas les problèmes résultant de situations échappant au contrôle de Yakima, y compris, entre autres, aux suivantes : le vol, l'abus, la surcharge, ou l'incapacité à assembler, à monter ou à utiliser le produit conformément aux instructions écrites par Yakima ou des instructions fournies avec le produit ou mises à disposition à l'acheteur au détail original. Si un produit est jugé défectueux, l'acheteur au détail original devra contacter le distributeur Whispbar auquel il a acheté le produit, qui lui donnera des instructions sur la marche à suivre. Si l'acheteur au détail original n'est pas en mesure de contacter le distributeur de la marque Whispbar, ou si le distributeur n'est pas à même de remédier au défaut, l'acheteur au détail original devra communiquer avec Yakima par e-mail à l'adresse suivante : [yakwarranty@yakima.com](mailto:yakwarranty@yakima.com), ou téléphoner au + 1 888.925.4621 pour s'enquérir au sujet des instructions d'expédition. Après avoir contacté directement Yakima, un technicien de Yakima donnera à l'acheteur au détail original les instructions appropriées pour retourner le produit à Yakima. Le coût de l'envoi du produit à Yakima sera à la charge de l'acheteur au détail original. Afin de redresser toute situation fâcheuse pendant toute la vigueur de cette garantie (occasionnée soit par un distributeur Whispbar, soit directement par Yakima), un justificatif d'achat sous la forme d'une facture originale d'achat ou d'un reçu est strictement requise.

## LIMITATION DE RESPONSABILITÉ

LA RÉPARATION OU LE REMPLACEMENT D'UN PRODUIT DÉFECTUEUX, OU ENCORE LA DÉLIVRANCE D'UN REMBOURSEMENT OU D'UN AVOIR (À LA DISCRÉTION DE YAKIMA), CONSTITUE LE RECOURS EXCLUSIF DE L'ACHETEUR AU DÉTAIL ORIGINAL TOUT AU LONG DE LA DURÉE DE VALIDITÉ DE CETTE GARANTIE. TOUT DOMMAGE OU TOUTE BLESSURE INFLIGÉ(E) À L'ACHETEUR AU DÉTAIL ORIGINAL, À SON VÉHICULE, À SON CHARGEMENT, OU À SA PROPRIÉTÉ, ET/OU À TOUTE AUTRE PERSONNE OU À TOUTE AUTRE PROPRIÉTÉ, N'EST PAS COUVERT PAR CETTE GARANTIE. CETTE GARANTIE EST EXPRESSÉMENT FAITE POUR REMPLACER TOUTE AUTRE GARANTIE EXPRESSE, QU'ELLE SOIT ORALE OU ÉCRITE. LA SEULE RESPONSABILITÉ DE YAKIMA EST LIMITÉE AU RECOURS DÉVELOPPÉ CI-DESSUS. EN AUCUN CAS, YAKIMA NE POURRA ÊTRE TENUE POUR RESPONSABLE DES DOMMAGES DIRECTS, INDIRECTS, CONSÉQUENTS, EXEMPLAIRES OU PUNITIFS OU DE TOUT AUTRE DOMMAGE DE QUELQUE NATURE QUE CE SOIT (Y COMPRIS, ENTRE AUTRES, DE MANQUES À GAGNER OU DE VENTES MANQUÉES).

## Garantie quinquennale Whispbar (UE)

Chez Whispbar, nous pouvons nous vanter de garantir que l'ensemble de nos produits est conçu, testé et fabriqué conformément aux exigences les plus strictes. Par ailleurs, tous les produits Whispbar vendus au sein de l'UE bénéficient d'une garantie quinquennale sur les pièces et la main d'oeuvre.

### I. Produits couverts et champs d'application.

La garantie Whispbar couvre les systèmes de porte-charges, les coffres de toit et les accessoires fabriqués par Whispbar et commercialisés sous la marque Whispbar, pour une durée de cinq ans à compter de la date de la remise du produit à l'acheteur au détail d'origine. Il s'agit d'une garantie couvrant l'ensemble des défauts sur les pièces ou de fabrication. Sous réserve des limitations et des exclusions indiquées ci-dessous, Whispbar remédiera à l'ensemble des défauts affectant les pièces ou de fabrication pendant toute la durée de la période de garantie, en réparant ou en remplaçant (au choix de Whispbar) le(s) composant(s) défectueux, et cela à titre gratuit (pièces et main d'oeuvre) pour l'acheteur d'origine. L'acheteur au détail d'origine devra prendre à sa charge tous frais associés au retour du/des composant(s)/produit(s) au commerçant Whispbar initial. Pour que la présente garantie puisse être mise en jeu, il sera nécessaire de produire une preuve d'achat, sous la forme de l'exemplaire original de la facture d'achat ou du ticket de caisse.

### II. Transfert de la garantie.

La présente garantie n'est accordée qu'au profit de l'acheteur au détail d'origine.

### III. Limitation des réclamations dans le cadre de la garantie.

Nulle garantie n'est accordée concernant les défauts trouvant leur origine dans des situations qui échappent au contrôle de Whispbar, comme, à titre non limitatif, une usure normale, une utilisation indue, la surcharge, des modifications ou des réparations non effectuées ou autorisées par Whispbar, ou encore dans l'assemblage, le montage ou l'utilisation du porte-charges ou de l'accessoire/des accessoires en cause d'une manière non conforme aux instructions écrites, aux lignes directrices et aux tests de sécurité de Whispbar.

De plus, nulle garantie n'est accordée concernant les défauts occasionnés par des accidents ou par un maniement illicite du véhicule sur lequel le produit aura été installé.

En outre, nulle garantie n'est accordée concernant les défauts causés par l'incapacité de l'utilisateur à assurer correctement sa charge, conformément aux recommandations de Whispbar.

La réparation ou le remplacement du produit Whispbar défectueux est la seule action dont l'acheteur d'origine pourra se prévaloir dans le cadre de la présente garantie. Tous dommages accessoires ou indirects sont exclus de la présente garantie. Les dommages causés au véhicule de l'utilisateur, à la charge ou à des biens appartenant à des tiers en sont exclus.

### IV. Garantie légale.

Les dispositions ci-dessus ne sauraient nullement restreindre les droits légaux dont l'acheteur ou des tiers pourraient se prévaloir au sens de la loi nationale applicable. Elles ne sauraient affecter davantage les droits de l'acheteur vis-à-vis de son vendeur, tels que prévus au sein du contrat d'achat conclu entre ces deux parties. C'est ainsi notamment que lesdites dispositions ne sauraient s'appliquer aux droits de garantie prescrits par la loi nationale applicable, lesquels demeurent inchangés (sous réserve de la mise en oeuvre de la garantie).

### V. Contacter Whispbar

Pour toute question particulière concernant la garantie Whispbar, veuillez contacter le commerçant Whispbar le plus proche ou celui auprès duquel vous avez acheté le produit. Vous pourrez trouver des informations concernant les commerçants sur le site Internet : [www.Whispbar.eu](http://www.Whispbar.eu)

Le donneur de garantie est Yakima Products, Inc., 15025 SW Koll Parkway, Beaverton, OR 97006, États-Unis d'Amérique.

Whispbar est une marque déposée de Yakima Products, Inc.

## Whispbar 5 års garanti (EU)

I Whispbar setter vi vår ære i å sørge for at alle produktene våre er konstruert, testet og produsert etter de høyeste kvalitetsstandardene. Alle Whispbar-produkter som selges i EU har dessuten 5 års garanti på materialer og utførelse.

### I. Produkter som dekkes og omfang

Whispbar garanterer i inntil fem år fra leveringsdato til den opprinnelige forbrukerkjøperen at takgrinder, takbokser og tilleggsutstyr, som produseres av Whispbar og selges under merkenavnet Whispbar, er fri for mangler i materialer og utførelse. Whispbar vil utbedre mangler i materialer eller utførelse i garantiperioden, med begrensningene og unntakene angitt nedenfor, ved å reparere eller skifte ut (etter Whispbars valg) de defekte komponentene uten at den opprinnelige kjøperen må betale for arbeidet eller komponentene. Den opprinnelige kjøperen skal være ansvarlig for kostnadene ved å returnere komponenten(e)/produktet(-ene) til den opprinnelige Whispbar-forhandleren. Bevis på kjøpet i form av en original faktura eller kvittering må fremlegges for at noen som helst utbedring vil bli vurdert i henhold til denne garantien.

### II. Overføring av garantien

Garantien gis kun til den opprinnelige kjøperen og kan ikke overføres.

### III. Begrensning av garantikrav

Garantien omfatter ikke mangler som er forårsaket av forhold som ligger utenfor Whispbars kontroll, inkludert, men ikke begrenset til, normal bruk og slitasje, misbruk, overbelastning, endringer eller reparasjoner som ikke er utført eller godkjent av Whispbar, eller feil sammensetting, montering eller bruk av takgrinden eller tilleggsutstyret i henhold til de skriftlige instruksjonene, retningslinjene eller sikkerhetsveiledningen fra Whispbar.

Garantien omfatter heller ikke mangler som skyldes ulykker, ulovlig bruk av kjøretøyet eller feil ved kjøretøyet som produktet monteres på.

Garantien omfatter heller ikke mangler som er forårsaket av at brukeren ikke fester lasten riktig, slik Whispbar anbefaler. Reparasjon eller utskifting av det mangelfulle Whispbar-produktet er den opprinnelige kjøperens eneste rettsmiddel etter garantien. Alle tilfeldige skader eller følgeskader er unntatt fra garantien. Skader på brukerens last, kjøretøy eller andre personer eller eiendom er unntatt.

### IV. Lovfestede krav påvirkes ikke

Bestemmelsene ovenfor begrenser ikke kjøpers eller tredjeparts lovfestede rettigheter i henhold til relevant, ufravikelig, nasjonal lovgivning. Heller ikke begrenser de kjøperens rettigheter overfor forhandleren etter kjøpekontrakten inngått mellom partene. Dette gjelder spesielt garantirettigheter i henhold til nasjonal lovgivning som fortsatt gjelder fullt ut, bortsett fra det faktum at garantitilfellet oppstår og at det fremlegges krav etter garantien eller ikke.

### V. Kontakt med Whispbar

Hvis du har spesielle spørsmål om Whispbar-garantien, kan du kontakte nærmeste Whispbar-forhandler eller forhandleren der produktet ble kjøpt. Forhandlerinformasjon kan du finne på [www.Whispbar.eu](http://www.Whispbar.eu).

Ansvarlig for garantien er Yakima Products Inc., 15025 SW Koll Parkway, Beaverton OR 97006, USA.

Whispbar er et registrert varemerke som eies av Yakima Products, Inc

## Garantia de 5 anos da Whispbar (UE)

Na Whispbar, orgulhamo-nos por garantir que todos os nossos produtos são concebidos, testados e fabricados de acordo com os mais elevados padrões de qualidade. Além disso, todos os produtos da Whispbar vendidos na UE têm uma garantia de 5 anos que abrange os materiais e o acabamento.

### I. Produtos abrangidos e alcance

A garantia da Whispbar, que abrange sistemas de transporte de cargas, caixas de tejadilho e acessórios produzidos pela Whispbar e vendidos com o nome comercial Whispbar, tem uma duração de cinco anos a partir da data de entrega do produto (sem defeitos a nível de material e acabamento) ao comprador final original.

Sujeito às limitações e exclusões abaixo indicadas, a Whispbar irá resolver defeitos de materiais ou acabamentos durante o período de garantia, recorrendo à reparação ou substituição (segundo a exclusiva opção da Whispbar) do(s) componente(s) com defeito, sem cobrar peças nem mão-de-obra ao comprador original. O comprador original é responsável pelo custo de devolução do(s) componente(s)/produto(s) ao revendedor original da Whispbar. Para se poder considerar qualquer tipo de resolução ao abrigo desta garantia é obrigatório apresentar o recibo ou a factura original da compra.

### II. Transmissão da garantia

A garantia é emitida exclusivamente para o comprador original e não é transmissível.

### III. Limitação das reclamações de garantia

A garantia não abrange defeitos resultantes de condições que não estão sob controlo da Whispbar, designadamente desgaste normal, utilização incorrecta, sobrecarregamento, modificações ou reparações não executadas nem autorizadas pela Whispbar, ou resultantes da incapacidade de montar, instalar ou utilizar o sistema de transporte de cargas ou acessórios em conformidade com as instruções, directrizes e texto de segurança da Whispbar.

A garantia também não abrange defeitos causados por acidentes, operação ilegal do veículo ou defeitos no veículo onde o produto se encontra instalado.

Além disso, a garantia não abrange defeitos provocados pelo facto de o utilizador não fixar correctamente a carga conforme recomendado pela Whispbar.

A reparação ou substituição do produto da Whispbar com defeito são as únicas soluções de que o comprador original dispõe ao abrigo da garantia. Todos os danos consequenciais e incidentais estão excluídos desta garantia. Os danos do veículo e da carga do utilizador ou sofridos por qualquer outra pessoa ou bens estão excluídos.

### IV. Garantias legais não afectadas

As anteriores disposições não representam uma restrição aos direitos legais do comprador ou de terceiros em conformidade com a legislação nacional obrigatória relevante. Também não afectam o direito do comprador em relação ao revendedor no que diz respeito ao contrato de compra e venda celebrado entre as duas partes. Isto aplica-se em particular a direitos de garantia, em conformidade com a legislação nacional aplicável, que se mantêm inalterados, independentemente de ocorrer a situação garantida e de a garantia ser ou não reclamada.

### V. Contacto com a Whispbar

Para qualquer pergunta específica sobre a garantia da Whispbar, entre em contacto com o revendedor mais próximo da Whispbar ou o revendedor onde adquiriu o produto. Visite [www.Whispba.eu](http://www.Whispba.eu) para obter informações sobre os revendedores.

O garante é a Yakima Products, Inc., 15025 SW Koll Parkway, Beaverton, OR 97006 EUA

A Whispbar é uma marca comercial registada da Yakima Products, Inc.

## 5-летняя гарантия на продукцию Whispbar (ЕС)

Компания Whispbar обеспечивает соблюдение высочайших стандартов качества при проектировании, тестировании и производстве всей своей продукции. Кроме того, для всех продаваемых в ЕС продуктов Whispbar предоставляется 5-летняя гарантия на материалы и качество изготовления.

### I. Покрываемые гарантией продукты и область применения

Компания Whispbar предоставляет гарантию на отсутствие дефектов материалов и качества изготовления производимых Whispbar и продаваемых с маркой Whispbar багажных систем, устанавливаемых на крыше багажников и аксессуаров на срок до 5 лет с момента поставки продукта первоначальному розничному покупателю.

С учетом приведенных ниже ограничений и исключений компания Whispbar обязуется устранять дефекты материалов или качества изготовления в течение гарантийного срока посредством ремонта или замены (на усмотрение компании Whispbar) некачественного(-ых) компонента(-ов) без взимания с первоначального покупателя стоимости соответствующих компонентов или работ. Расходы, связанные с возвратом компонента(-ов)/продукта(-ов) первоначальному продавцу Whispbar, оплачиваются первоначальным покупателем. Для реализации права на гарантию необходимо предоставить доказательство совершенной покупки в виде оригинала счета на ее оплату или чека.

### II. Передача гарантии

Гарантия предоставляется только первоначальному розничному покупателю и не подлежит передаче другим лицам.

### III. Ограничение претензий по гарантии

Гарантия не распространяется на дефекты, возникшие по не зависящим от компании Whispbar причинам, включая помимо прочего нормальный износ, ненадлежащее использование, перегрузку, модификации или ремонт, выполненные без участия компании Whispbar или одобрения с ее стороны, а также невыполнение письменных указаний, рекомендаций и правил техники безопасности компании Whispbar при сборке, монтаже или эксплуатации багажной системы или аксессуаров. Кроме того, гарантия не распространяется на дефекты, возникшие в результате дорожно-транспортных происшествий, незаконного управления транспортным средством или недостатков транспортного средства, на котором установлено изделие.

Кроме того, гарантия не распространяется на повреждения, связанные с невыполнением рекомендаций компании Whispbar по креплению груза.

Ремонт или замена некачественного изделия Whispbar является единственным средством правовой защиты первоначального покупателя в рамках гарантии. Все сопутствующие и вытекающие повреждения под настоящую гарантию не подпадают.

Гарантия не распространяется на ущерб, нанесенный принадлежащему пользователю транспортному средству или грузу, а также здоровью или имуществу других лиц.

### IV. Сохраняющие силу законные притязания

Приведенные выше положения не ограничивают законные права покупателя или третьих лиц в соответствии с действующим национальным законодательством. Они также не затрагивают права покупателя по отношению к дилеру на основании заключенного между ними договора купли-продажи. В частности, это распространяется на гарантийные права в соответствии с действующим национальным законодательством, сохраняющие свою полную силу независимо от факта возникновения гарантийного случая и предъявления гарантийной претензии или отсутствия таковой.

### V. Контакты с компанией Whispbar

По любым вопросам, связанным с гарантией на продукцию Whispbar, обращайтесь к ближайшему дилеру Whispbar или дилеру, у которого был приобретен продукт. Информация о дилерах приведена на сайте [www.Whispbar.eu](http://www.Whispbar.eu)

Гарантом является компания Yakima Products, Inc., зарегистрированная по адресу: 15025 SW Koll Parkway, Beaverton, OR 97006 USA (США)

Whispbar является зарегистрированной торговой маркой компании Yakima Products, Inc.