

# Thule Rapid System Kit 1689

# > Instructions

**LEXUS GS250**, 4-dr Sedan, 12-  
**LEXUS GS350**, 4-dr Sedan, 12-  
**LEXUS GS450**, 4-dr Sedan, 12-

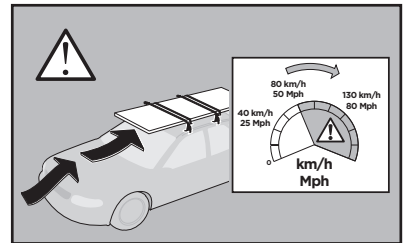
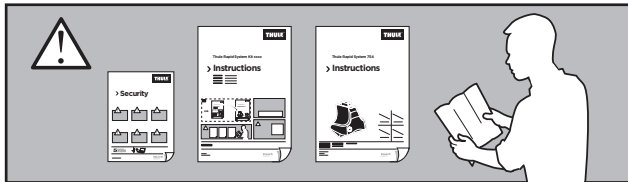
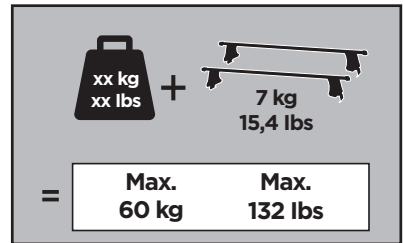
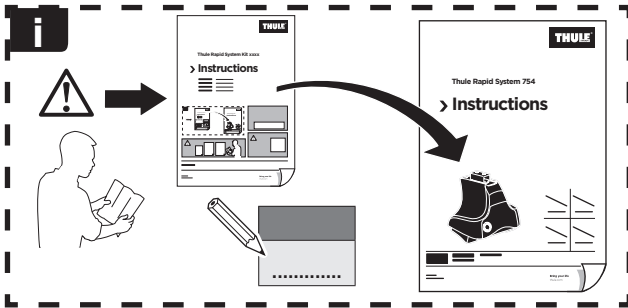

ISO 11154-E

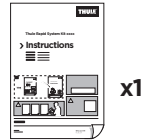
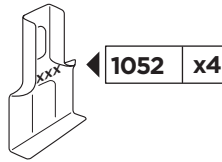
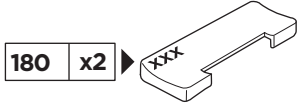
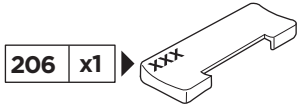
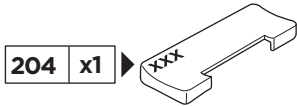

# 1

	X (scale)	X (mm)	X (inch)
<b>LEXUS GS250</b> , 4-dr Sedan, 12-	<b>34,5</b>	<b>996</b>	<b>39 1/4</b>
<b>LEXUS GS350</b> , 4-dr Sedan, 12-	<b>34,5</b>	<b>996</b>	<b>39 1/4</b>
<b>LEXUS GS450</b> , 4-dr Sedan, 12-	<b>34,5</b>	<b>996</b>	<b>39 1/4</b>

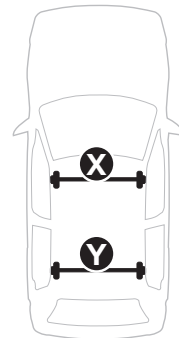
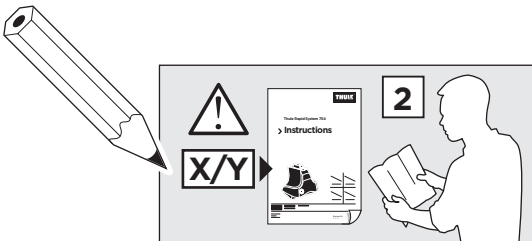

	Y (scale)	Y (mm)	Y (inch)
<b>LEXUS GS250</b> , 4-dr Sedan, 12-	<b>34</b>	<b>991</b>	<b>39</b>
<b>LEXUS GS350</b> , 4-dr Sedan, 12-	<b>34</b>	<b>991</b>	<b>39</b>
<b>LEXUS GS450</b> , 4-dr Sedan, 12-	<b>34</b>	<b>991</b>	<b>39</b>

# 2

LEXUS GS250, 4-dr Sedan, 12-

LEXUS GS350, 4-dr Sedan, 12-

LEXUS GS450, 4-dr Sedan, 12-

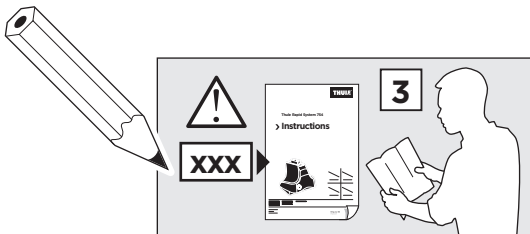
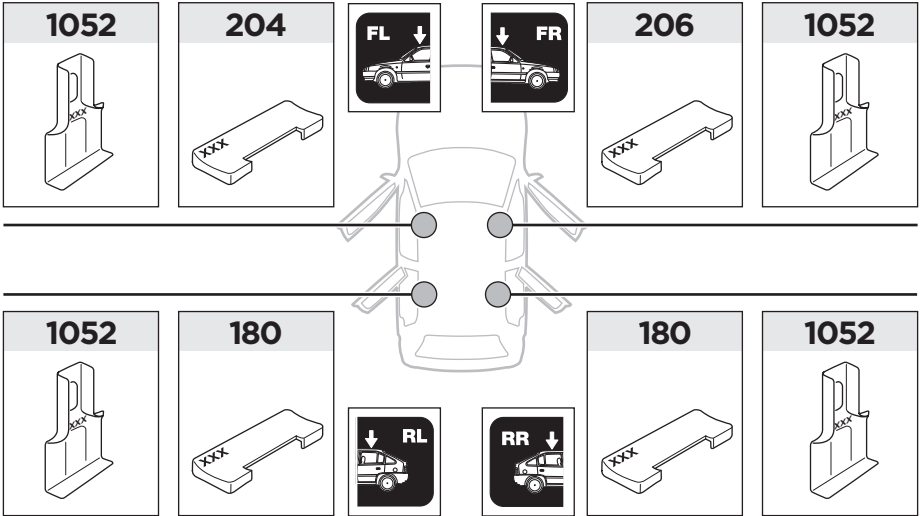

**3**

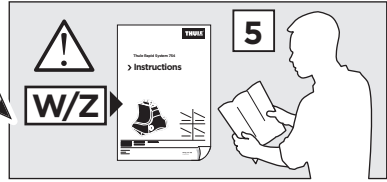

	W (mm)	Z (mm)	W (inch)	Z (inch)
<b>LEXUS GS250</b> , 4-dr Sedan, 12-	210	730	8 1/4"	28 3/4"
<b>LEXUS GS350</b> , 4-dr Sedan, 12-	210	730	8 1/4"	28 3/4"
<b>LEXUS GS450</b> , 4-dr Sedan, 12-	210	730	8 1/4"	28 3/4"

