

# Kit 1072

MERCEDES A-Class, 5-dr Hatchback, 98-00

MERCEDES A-Class (W168), 5-dr Hatchback, 01-04

480R  
754

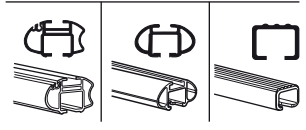
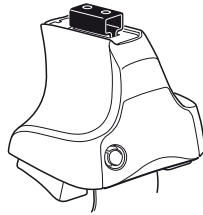

480

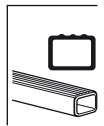
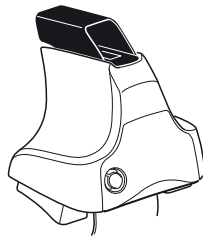

750

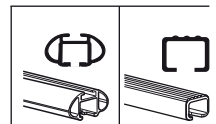
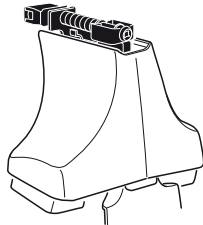

**Kit**





**1**

**2**

	X
MERCEDES A-Class, 5-dr Hatchback, 98-00	32
MERCEDES A-Class (W168), 5-dr Hatchback, 01-04	32,5

**1**

**2**

	Y
MERCEDES A-Class, 5-dr Hatchback, 98-00	25,5
MERCEDES A-Class (W168), 5-dr Hatchback, 01-04	26

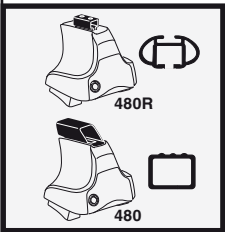

**1**

**2**

	X inch	X mm
MERCEDES A-Class, 5-dr Hatchback, 98-00	38 1/8"	971 mm
MERCEDES A-Class (W168), 5-dr Hatchback, 01-04	38 3/8"	976 mm

**1**

**2**

	Y inch	Y mm
MERCEDES A-Class, 5-dr Hatchback, 98-00	35 5/8"	906 mm
MERCEDES A-Class (W168), 5-dr Hatchback, 01-04	35 7/8"	911 mm

# 4

MERCEDES A-Class, 5-dr Hatchback, 98-00

MERCEDES A-Class (W168), 5-dr Hatchback, 01-04

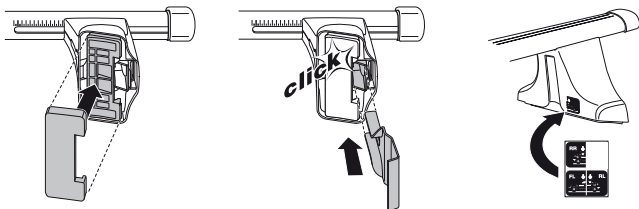
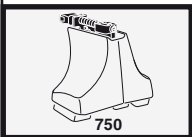
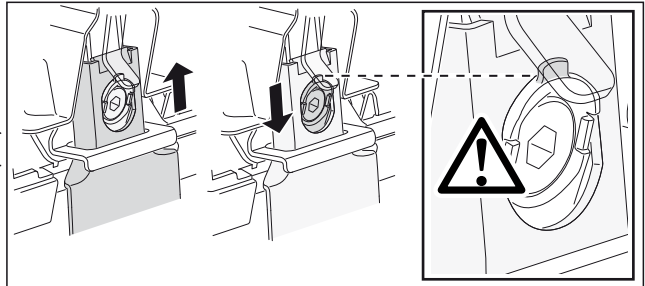
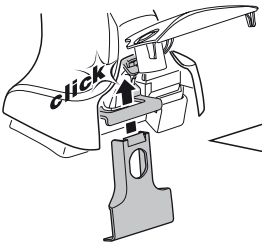
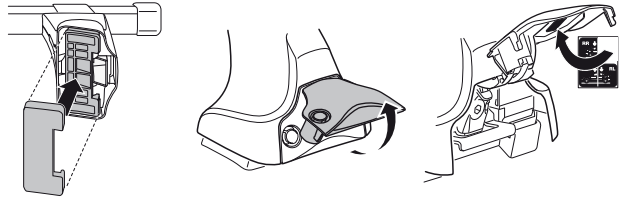
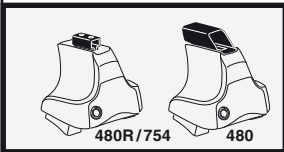
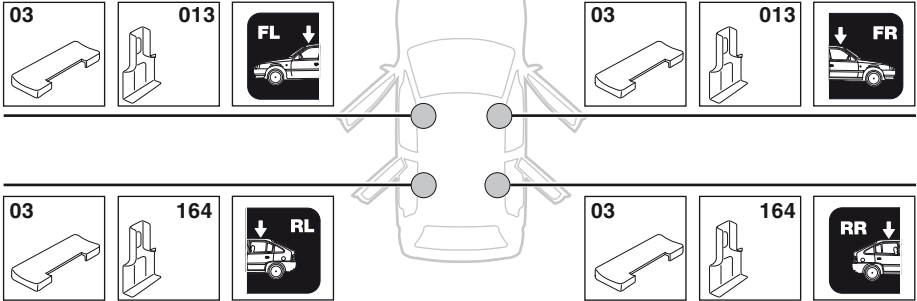

5



	X mm	Y mm	X inch	Y inch
MERCEDES A-Class, 5-dr Hatchback, 98-00	130 mm	650 mm	5 1/8"	25 5/8"
MERCEDES A-Class (W168), 5-dr Hatchback, 01-04	130 mm	700 mm	5 1/8"	27 1/2"

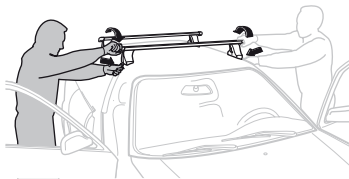
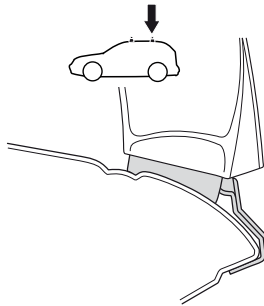
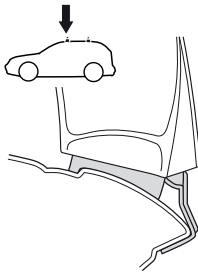
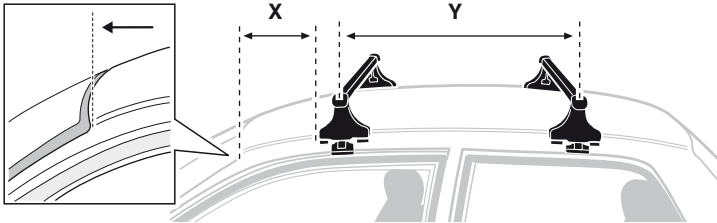

**GB/US** Tighten alternately

**D** Die Schrauben abwechselnd anziehen

**F** Serrer alternativement chaque côté

**NL** Afwisselend aan de linker- en de rechterkant aandraaien

**I** Alternare il serraggio delle viti

**E** Apretar alternativamente

**PT** Aperte alternadamente

**S** Dra åt växelvis

**FIN** Kierrä vuorotellen

**EST** Pinguldage vaheldumisi

**LAT** Pielieciet pamišus

**LIT** Užsukinėkite pakaitomis

**PL** Śruby dokręcaj naprzemiennie

**RU** Затягивайте попеременно

**CZ** Pokręťta bagażníka dokręcaj dokręcaj naprzemiennie.

**SK** Doťahujte striedavo

**SLO** Privijajte izmenično.

**HR** Naizmjenično zategnite

**HU** Egymástól függetlenül szorítandó

**GR** Σφίγγετε εναλλάξ

**TR** Dönüşümlü sıkın

**中文** 交替拧紧

**한국어** 번갈아 가며 조이십시오.

**日本語** 交互に締め付けてください。

**ไทย** ชั้้นในแบบสลับ

6



480R/754



480

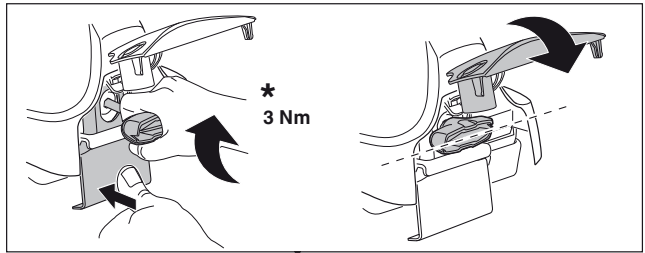
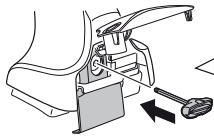

\*  
3 Nm

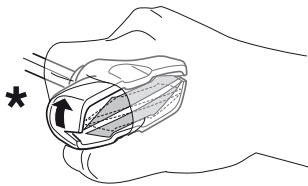

\*

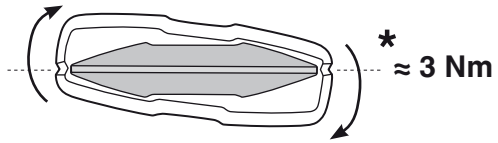

\*  
≈ 3 Nm

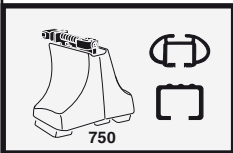
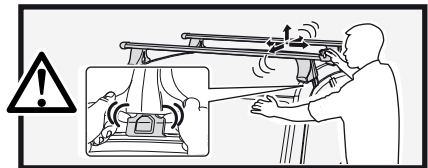

750

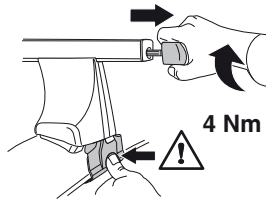

4 Nm

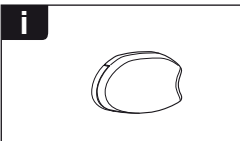
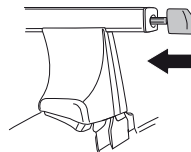

i

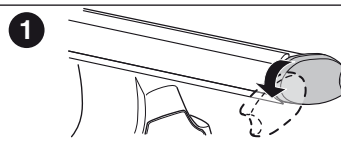

1

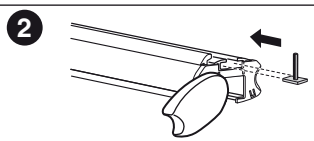

2

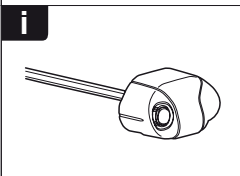

i

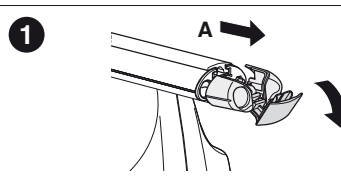

1

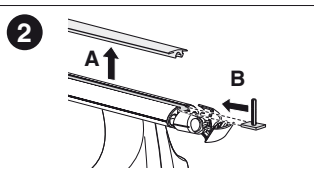

2

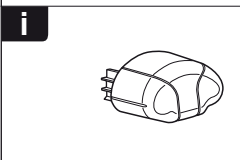

i

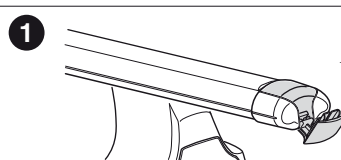

1

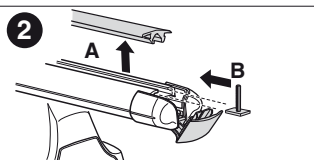

2

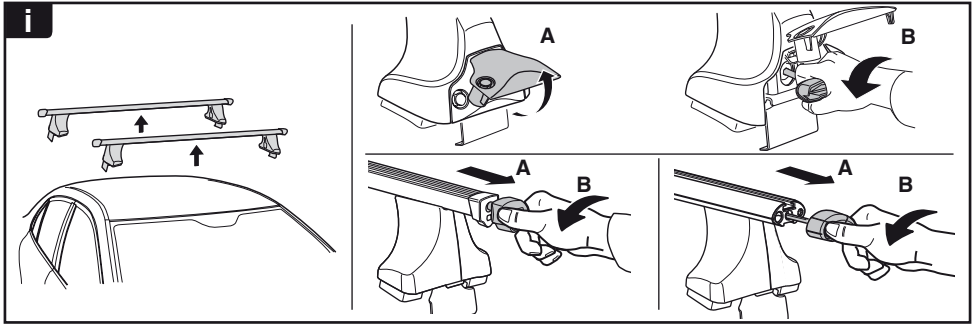

**THULE**  
SWEDEN  
**ONE  
KEY  
SYSTEM**

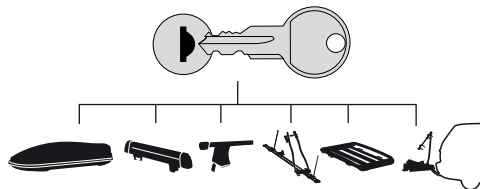

- 544** (x4)
- 596** (x6)
- 588** (x8)
- NA **510** (x10)
- EUR **452** (x12)
- ASIA

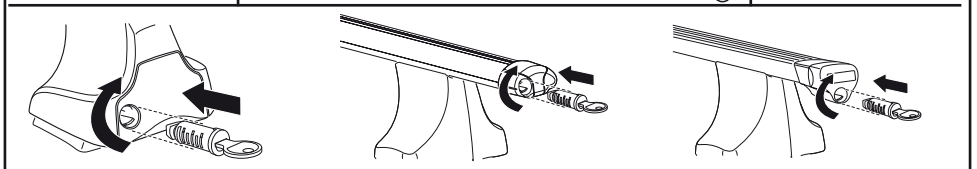

WW ▶ Thule Sweden AB, Box 69, 330 33 Hillerstorp, SWEDEN  
NA ▶ Thule Inc., 42 Silvermine Road, Seymour, Connecticut 06483, USA

info@thule.com  
customer.service@thule.com

www.thule.com