

Kit 1381

HONDA FR-V, 5-dr MPV, 04–
HONDA Edix, 5-dr MPV, 04– (JPN)

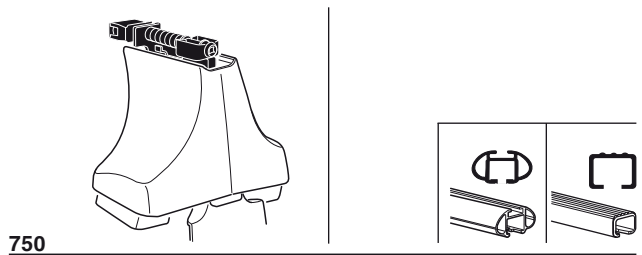
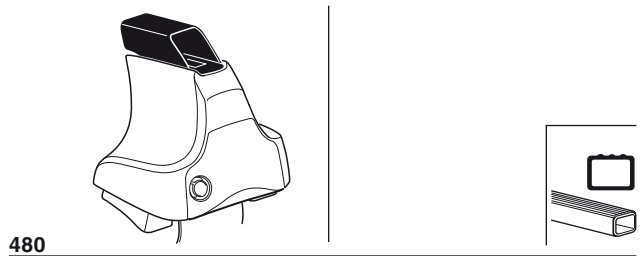
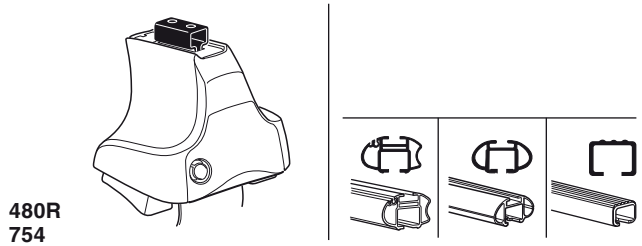

x2	x2	x2	x2	x2
x2	x2	x2	x2	x2
x2	x2	x4	x4	x4
x4		x4		

Kit

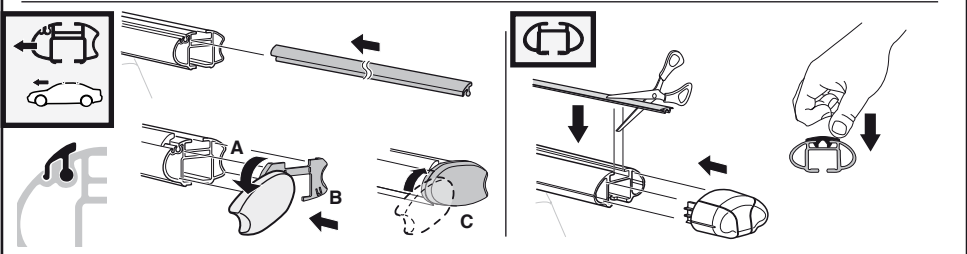
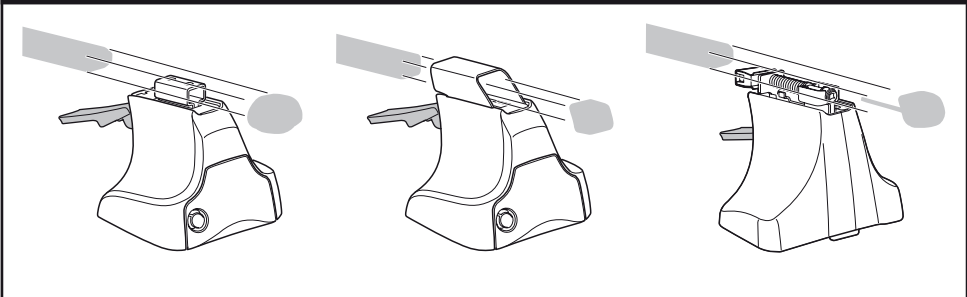

3



754

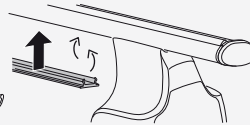
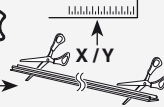

750



1

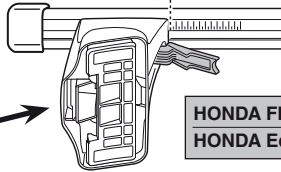
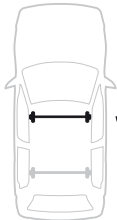

2

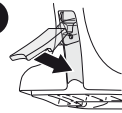

	X	
HONDA FR-V, 5-dr MPV, 04-	62,5	
HONDA Edix, 5-dr MPV, 04- (JPN)	62,5	

1

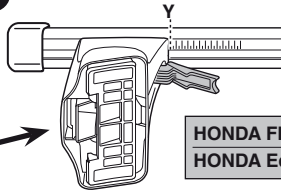

2

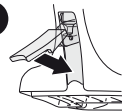

	Y	
HONDA FR-V, 5-dr MPV, 04-	55,5	
HONDA Edix, 5-dr MPV, 04- (JPN)	55,5	



480R



480

1

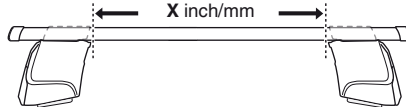
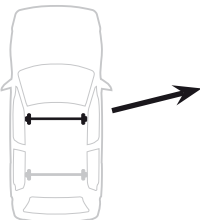

2

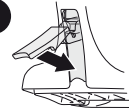

	X inch	X mm
HONDA FR-V, 5-dr MPV, 04-	50 1/4"	1276 mm
HONDA Edix, 5-dr MPV, 04- (JPN)	50 1/4"	1276 mm

1

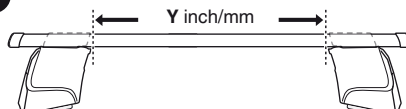
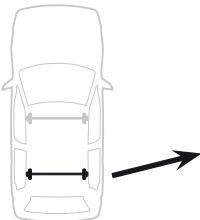

2

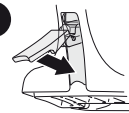

	Y inch	Y mm
HONDA FR-V, 5-dr MPV, 04-	47 1/2"	1206 mm
HONDA Edix, 5-dr MPV, 04- (JPN)	47 1/2"	1206 mm

4

HONDA FR-V, 5-dr MPV, 04-
 HONDA Edix, 5-dr MPV, 04- (JPN)

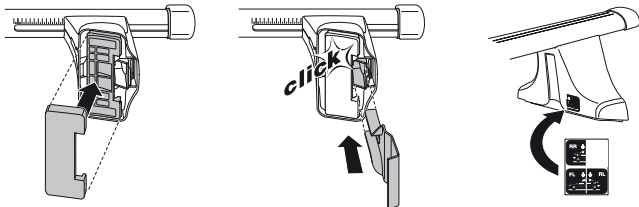
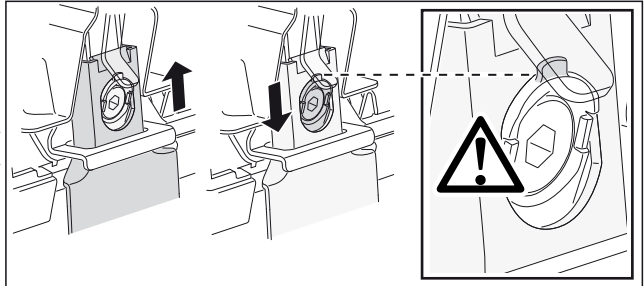
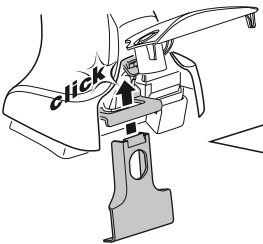
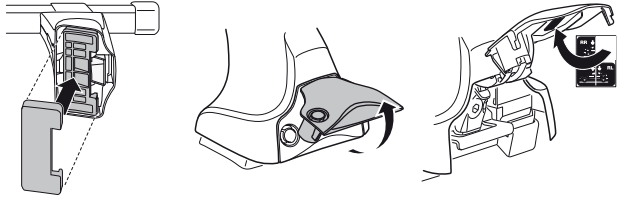
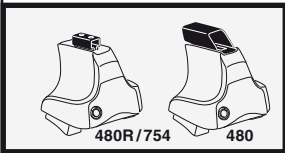
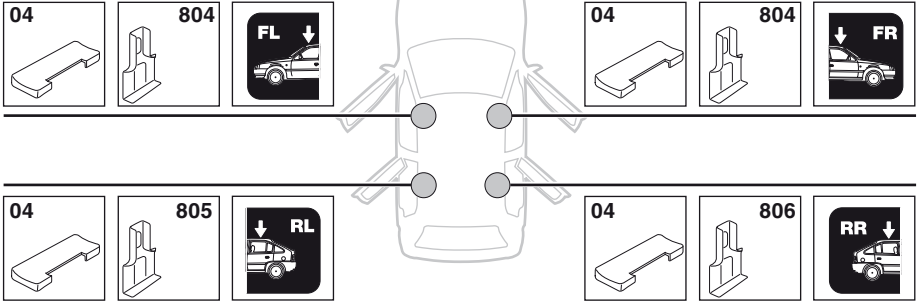

5

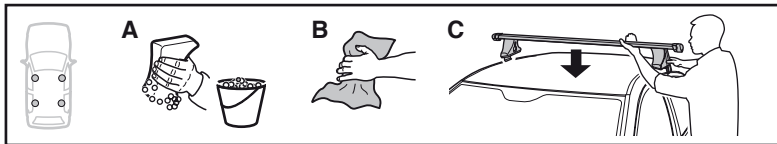

	X mm	Y mm	X inch	Y inch
HONDA FR-V, 5-dr MPV, 04-	360 mm	720 mm	14 1/8"	28 3/8"
HONDA Edix, 5-dr MPV, 04- (JPN)	360 mm	720 mm	14 1/8"	28 3/8"

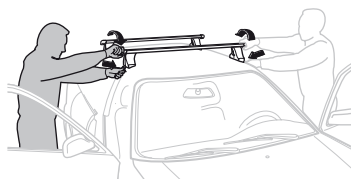
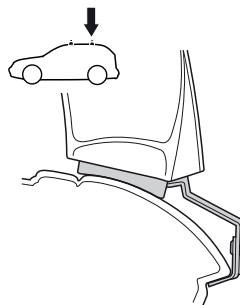
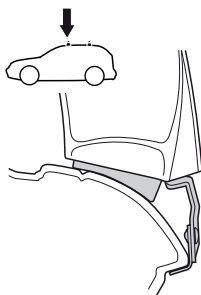
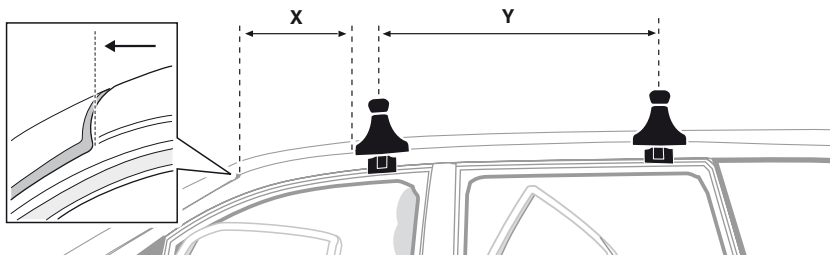

GB/US Tighten alternately

D Die Schrauben abwechselnd anziehen

F Serrer alternativement chaque côté

NL Afwisselend aan de linker- en de rechterkant aandraaien

I Alternare il serraggio delle viti

E Apretar alternativamente

PT Aperte alternadamente

S Dra åt växelvis

FIN Kierrä vuorotellen

EST Pinguldage vaheldumisi

LAT Pielvelciet pamišus

LIT Užsukinėkite pakaitomis

PL Śruby dokręcaj naprzemiennie

RU Затягивайте попеременно

CZ Pokręťta bagażníka dokręcaj dokręcaj naprzemiennie.

SK Doťahujte striedavo

SLO Privijajte izmenično.

HR Naizmjenično zategnite

HU Egymástól függetlenül szorítandó

GR Σφιγγετε εναλλάξ

TR Dönüşümlü sıkın

中文 交替拧紧

한국어 번갈아 가며 조이십시오.

日本語 交互に締め付けてください。

ไทย ชั้้นโน้แบบสลับ

6



480R/754



480

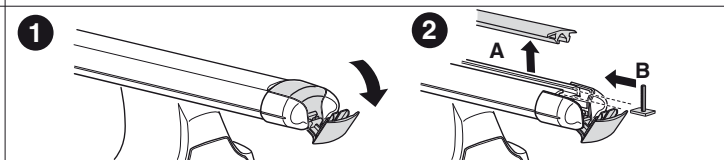
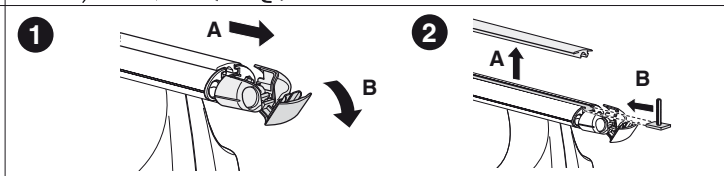
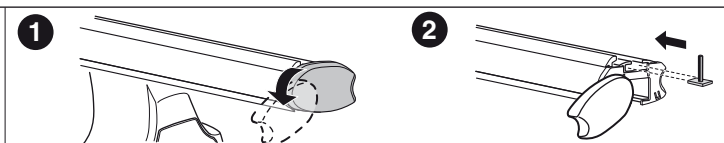
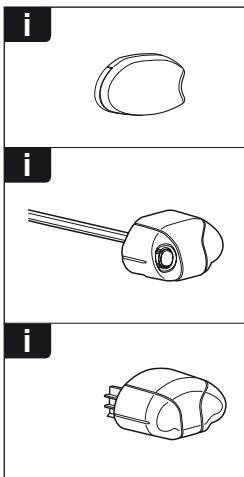
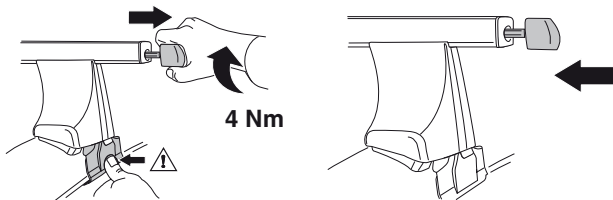
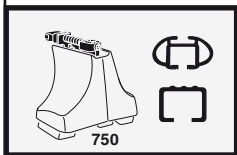
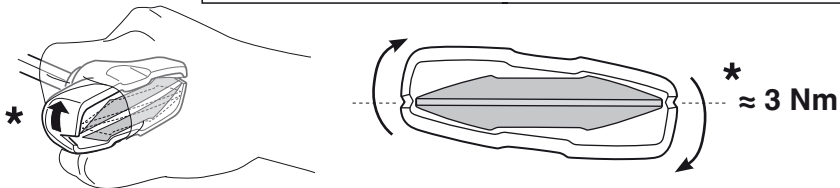
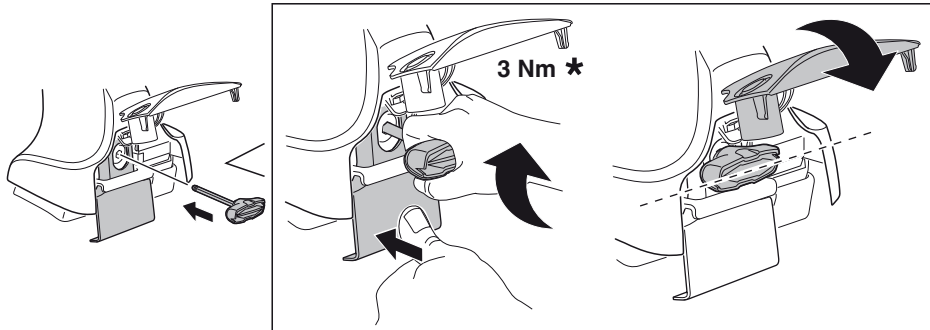

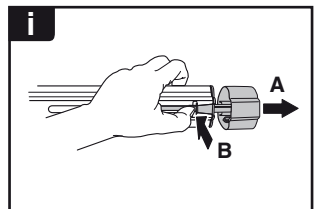
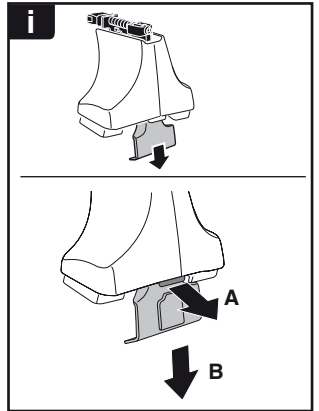
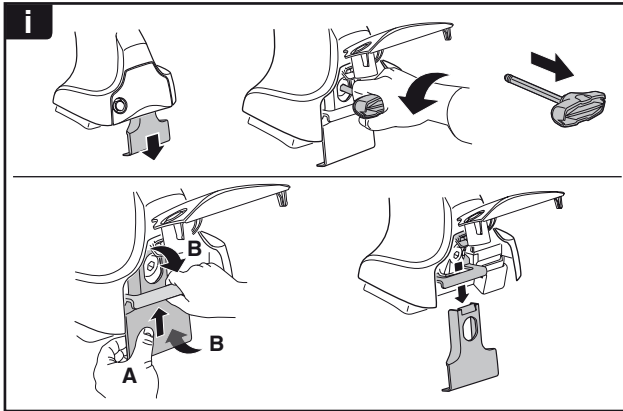
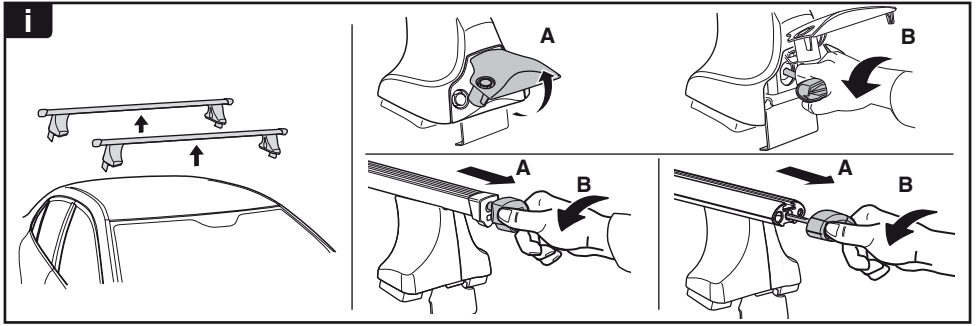

THULE
SWEDEN
**ONE
KEY
SYSTEM**



- 544** (x4)
- 596** (x6)
- 588** (x8)
- NA **510** (x10)
- EUR **452** (x12)
- ASIA

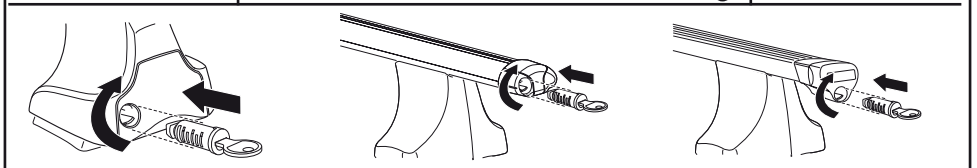

WW ▶ Thule Sweden AB, Box 69, 330 33 Hillerstorp, SWEDEN
NA ▶ Thule Inc., 42 Silvermine Road, Seymour, Connecticut 06483, USA

info@thule.com
customer.service@thule.com

www.thule.com