

# Kit 3027

GREAT WALL X240, 5-dr SUV, 06–

LAND ROVER Discovery (Mk.III), 5-dr SUV, 04-09

LAND ROVER Discovery (Mk.IV), 5-dr SUV, 09–

This Kit is only for vehicles with T-profile.

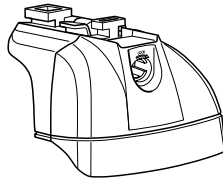

460R  
753

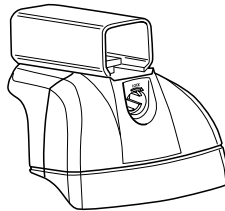
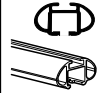

460

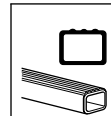

## GREAT WALL X240



Max.  
75 kg  
Max.  
165 lbs

## LAND ROVER Discovery



Max.  
100kg  
Max.  
220 lbs

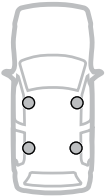
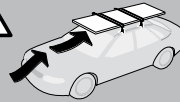
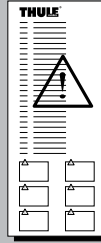

A



B



C

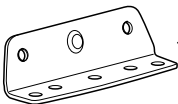
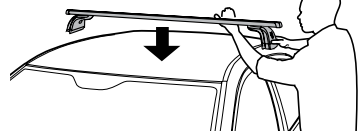

09 x 4

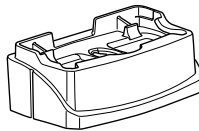

43 x 4



x 1

50784



x 4

30154



x 4

51320

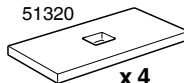

x 4

50577

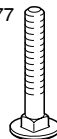

x 4

50273

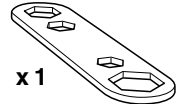

x 1

**Kit**



753

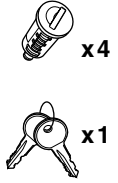
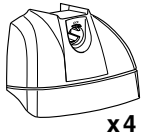

460R

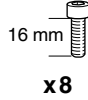
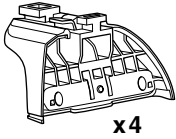

460

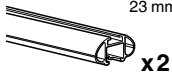
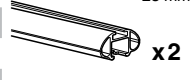
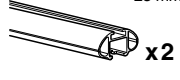
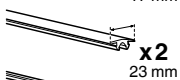
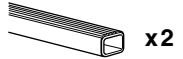
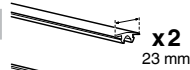
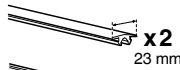
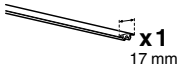
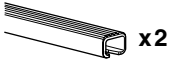
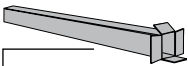
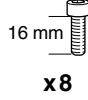
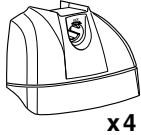
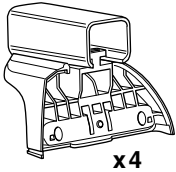

1

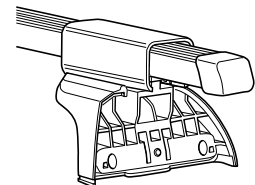
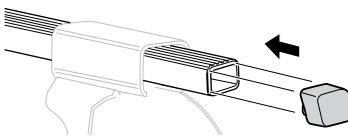
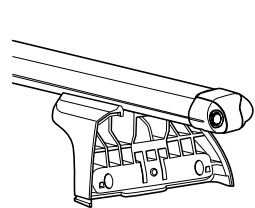
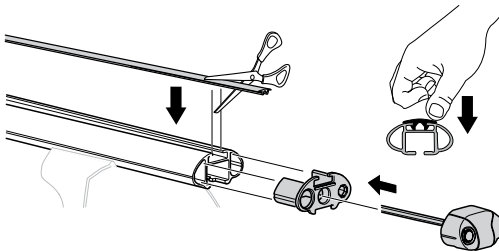
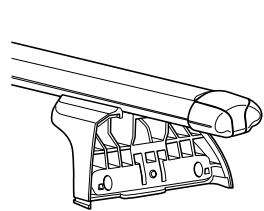
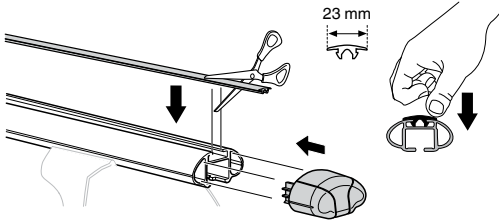
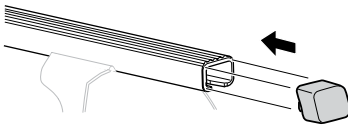
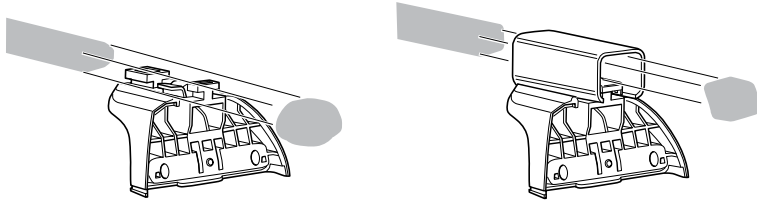
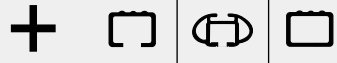
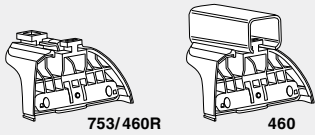

2

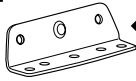

◀ 09 x 4

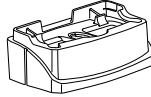

◀ 43 x 4



16 mm x 8



x 1

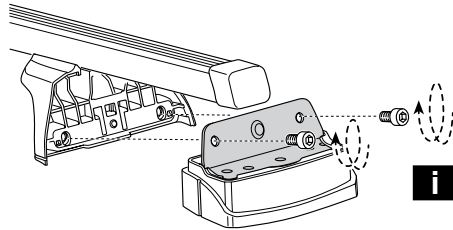
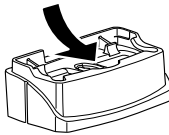
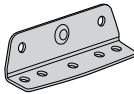
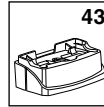
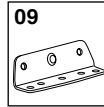
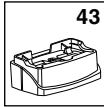
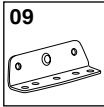
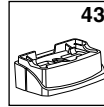
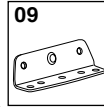
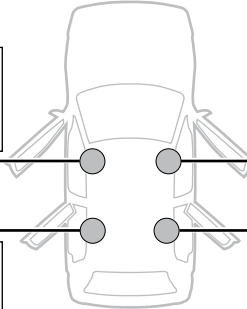
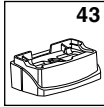
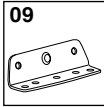

- GB** Only a few turns
- D** Nur wenige Umdrehungen
- F** Quelques tours uniquement
- NL** Slechts enkele slagen
- I** Solo qualche giro
- E** Sólo algunas vueltas
- PT** Noções básicas
- S** Endast några varv
- FIN** Vain muutama kierros

- EST** Ainult mõni pööre
- LAT** Tikai dažī apgriezieni
- LIT** Tik keli pasukimai
- PL** Wystarczy kilka obrotów
- RU** Достаточно нескольких оборотов
- CZ** Pouze několik otáček
- SK** Len niekoľko otáčok
- SLO** Le nekaj obratov

- HR** Samo nekoliko okreta
- HU** Csak néhány fordítás
- GR** Μόνο μερικές στροφές
- TR** Yalnız birkaç kez çevirm
- 中文** 只有几个转向
- 한국어** 두 세번만
- 日本語** 数回転のみ
- ไทย** หมุนเพียงไม่กี่รอบ

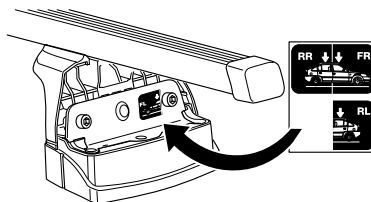

**3**



x4



x4

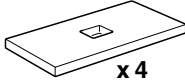

x4

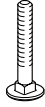

x4

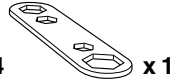

x1

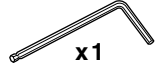

x1

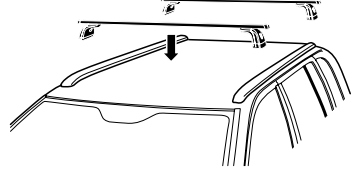
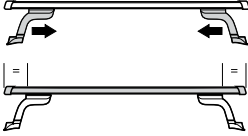

**A**

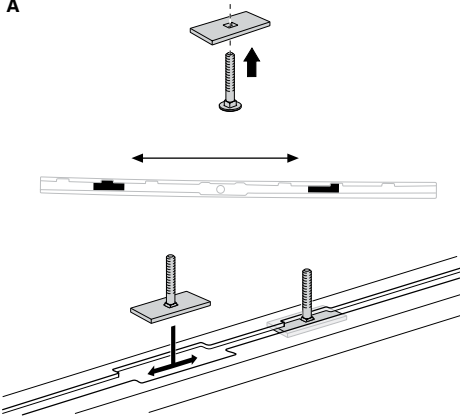

**B**

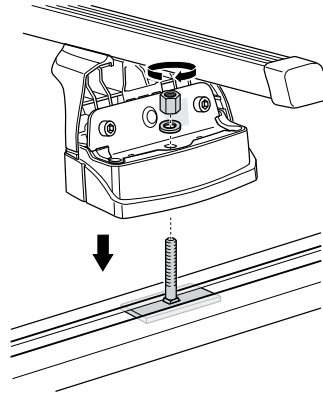

**C**

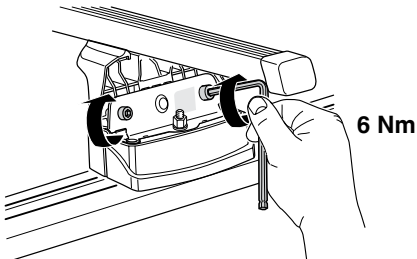

**D**

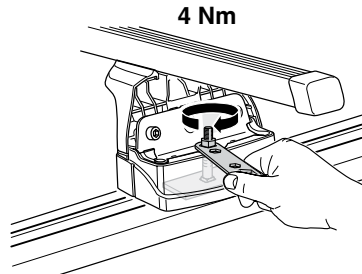

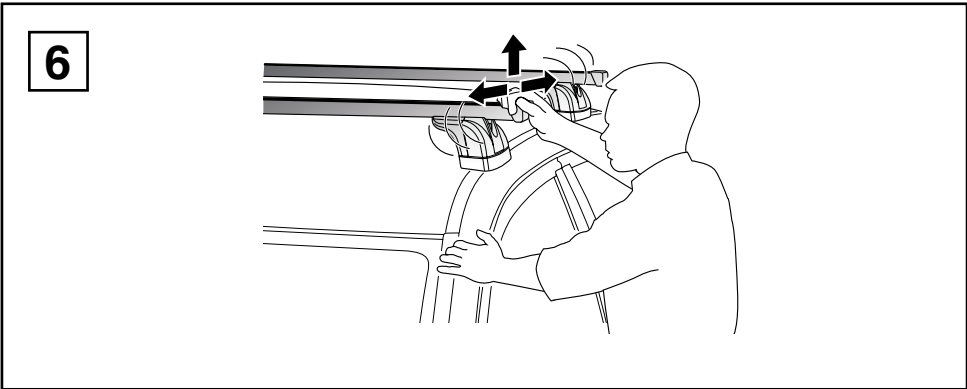
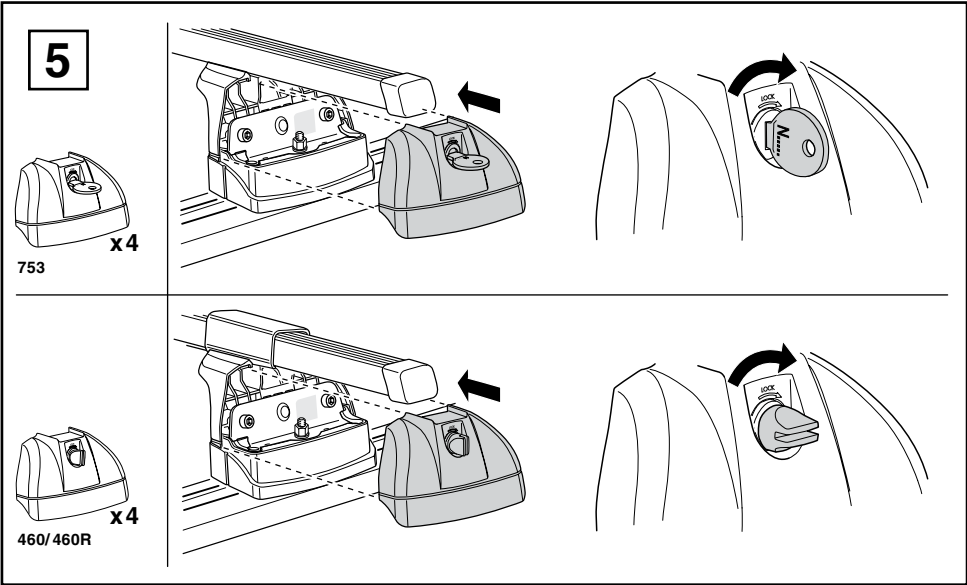
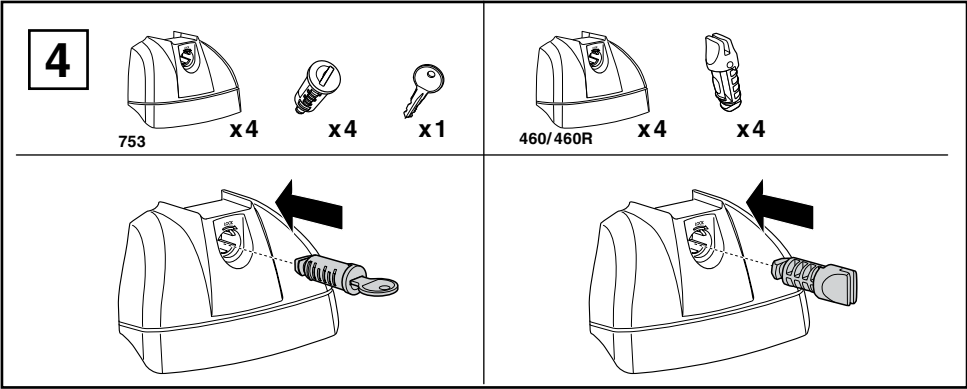

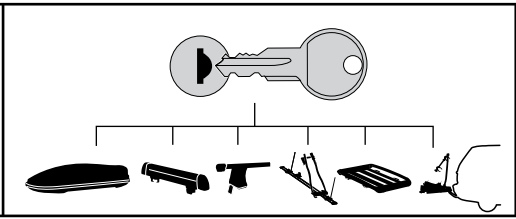
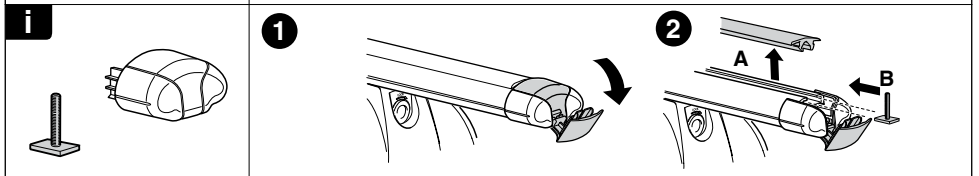
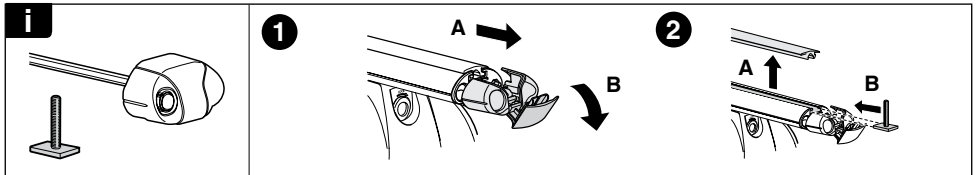
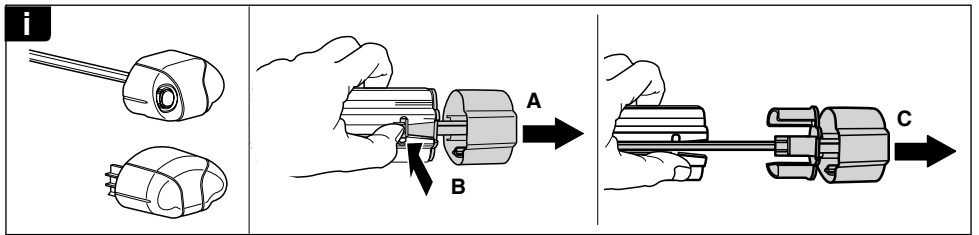
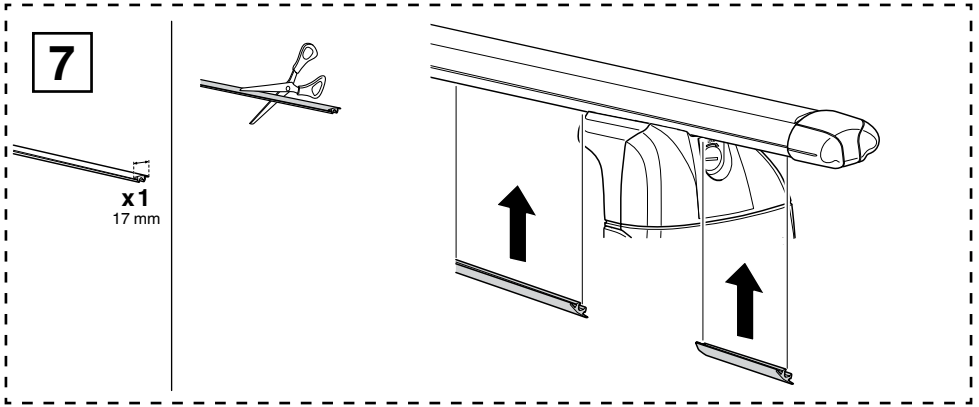

- 544 (x4)
- 596 (x6)
- 588 (x8)
- NA 510 (x10)
- EUR 452 (x12)

WW ▶ Thule Sweden AB, Box 69, 330 33 Hillerstorp, SWEDEN  
 NA ▶ Thule Inc., 42 Silvermine Road, Seymour, Connecticut 06483, USA

info@thule.com  
 customer.service@thule.com

www.thule.com