

Kit 1124

NISSAN Cube, 5-dr MPV, 98-01

FORD Fusion, 5-dr Hatchback, 02-05

480R
754

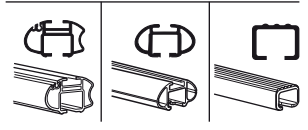
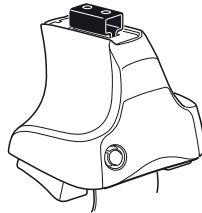

480

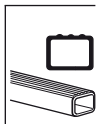
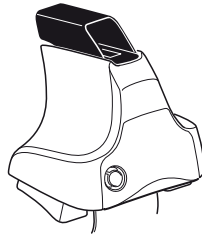

750

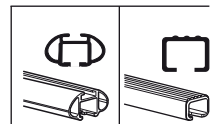
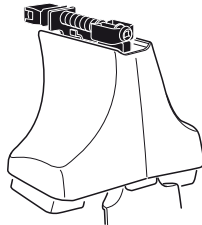

Kit

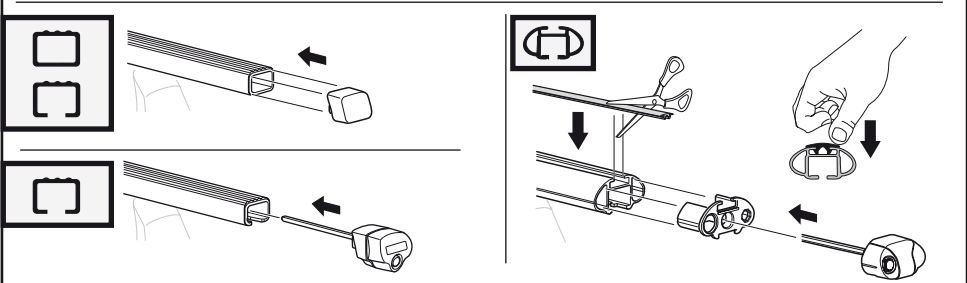
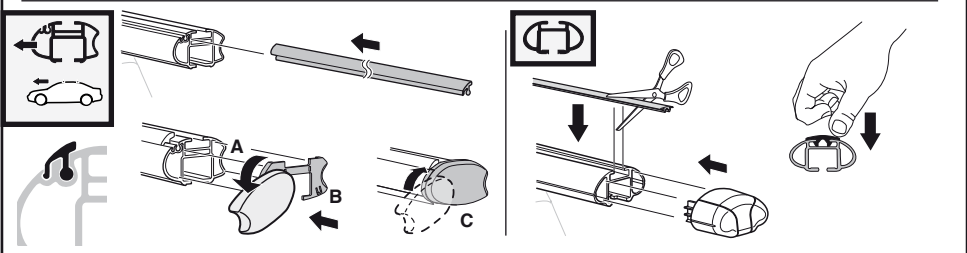
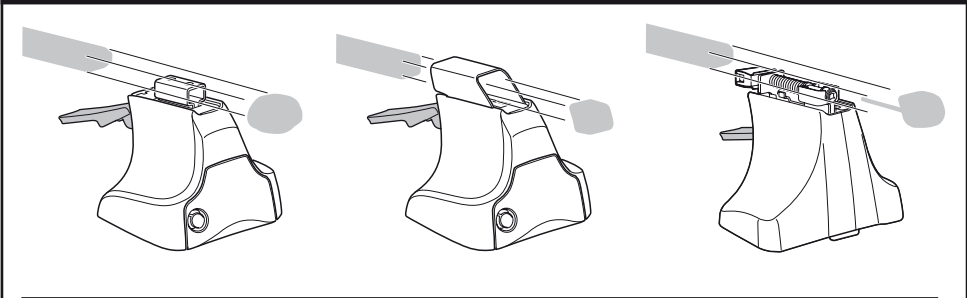
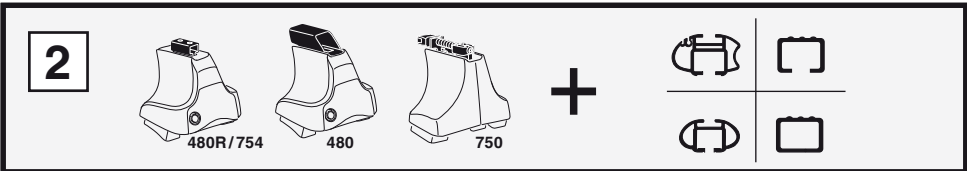
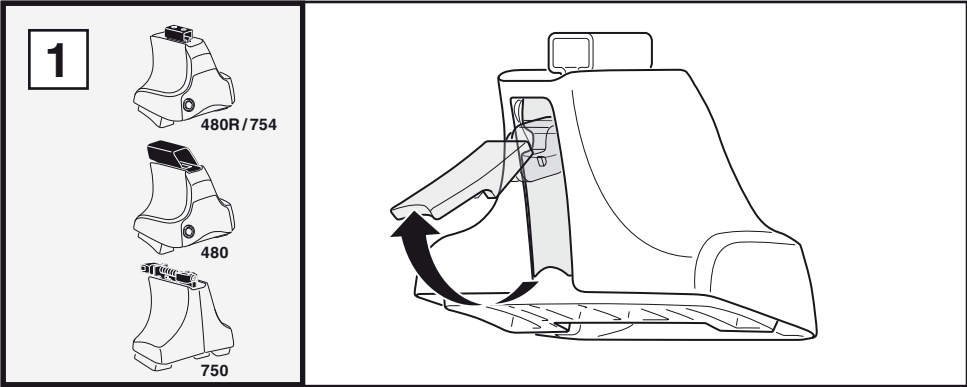

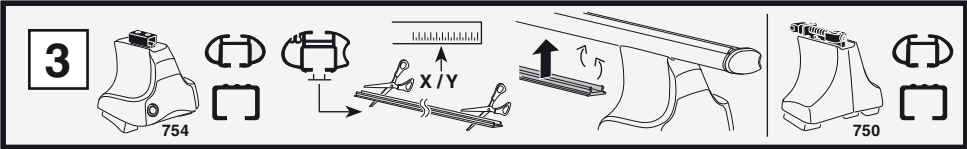

1

2

	X
NISSAN Cube, 5-dr MPV, 98-01	33,5
FORD Fusion, 5-dr Hatchback, 02-05	36

1

2

	Y
NISSAN Cube, 5-dr MPV, 98-01	30,5
FORD Fusion, 5-dr Hatchback, 02-05	32

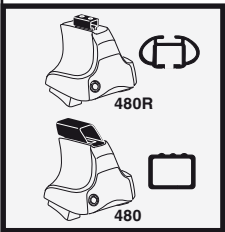

1

2

	X inch	X mm
NISSAN Cube, 5-dr MPV, 98-01	38 7/8"	986 mm
FORD Fusion, 5-dr Hatchback, 02-05	39 3/4"	1011 mm

1

2

	Y inch	Y mm
NISSAN Cube, 5-dr MPV, 98-01	37 5/8"	956 mm
FORD Fusion, 5-dr Hatchback, 02-05	38 1/4"	971 mm

4

NISSAN Cube, 5-dr MPV, 98-01

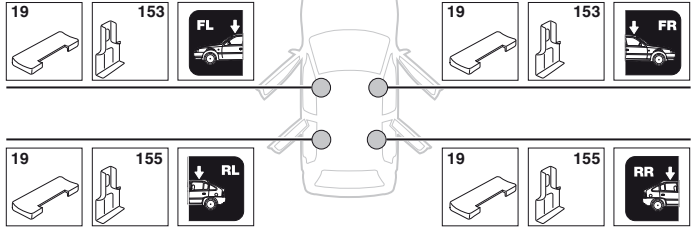

FORD Fusion, 5-dr Hatchback, 02-05

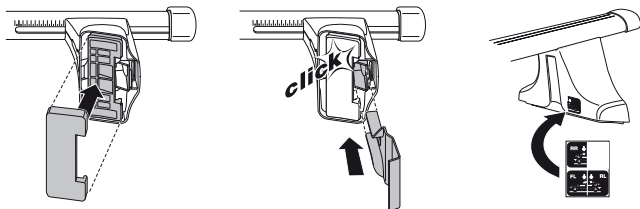
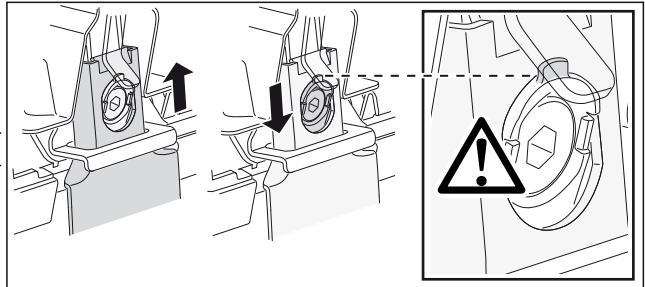
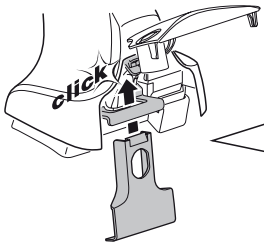
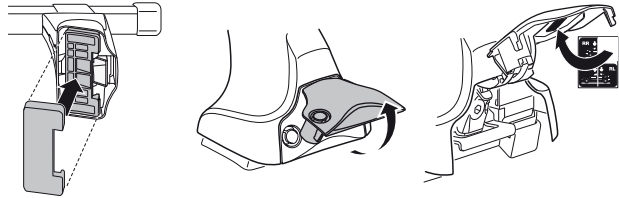
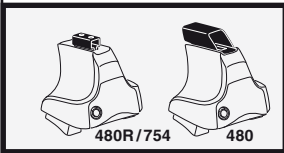
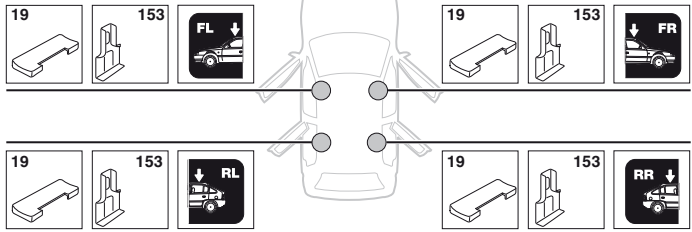

5

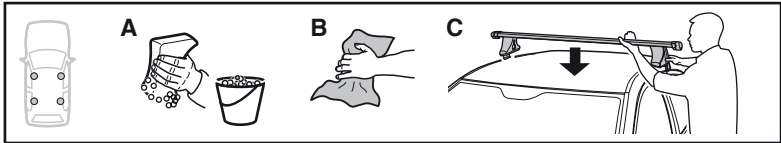

	X mm	Y mm	X inch	Y inch
NISSAN Cube, 5-dr MPV, 98-01	350 mm	700 mm	13 3/4"	27 1/2"
FORD Fusion, 5-dr Hatchback, 02-05	300 mm	700 mm	11 3/4"	27 1/2"

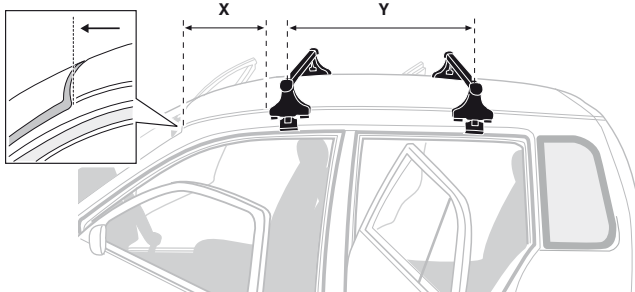

NISSAN Cube, 5-dr MPV, 98-01

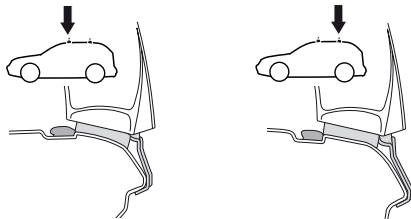

FORD Fusion, 5-dr Hatchback, 02-05

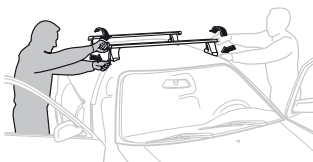
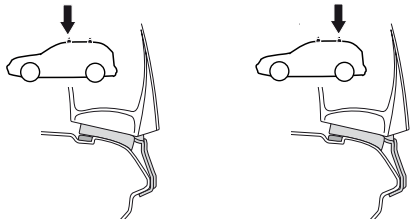

- GB/US** Tighten alternately
D Die Schrauben abwechselnd anziehen
F Serrer alternativement chaque côté
NL Afwisselend aan de linker- en de rechterkant aandraaien
I Alternare il serraggio delle viti
E Apretar alternativamente
PT Aperte alternadamente
S Dra åt växelvis
FIN Kierrä vuorotellen
EST Pinguldage vaheldumisi
LAT Pievelciēt pamišus
LIT Užsukinėkite pakaitomis
PL Śruby dokręcaj naprzemiennie
RU Затягивайте попеременно

- CZ** Pokręťta багаžníka dokręcaj dokręcaj naprzemiennie.
SK Dofahujtie striedavo
SLO Privijajte izmenično.
HR Naizmjenično zategnite
HU Egymástól függetlenül szorítandó
GR Σφιγίγτε εναλλάξ
TR Dönüşümlü sıkın
中文 交替拧紧
한국어 번갈아 가며 조이십시오.
日本語 交互に締め付けてください。
ไทย ชั้้นในแบบสลับ

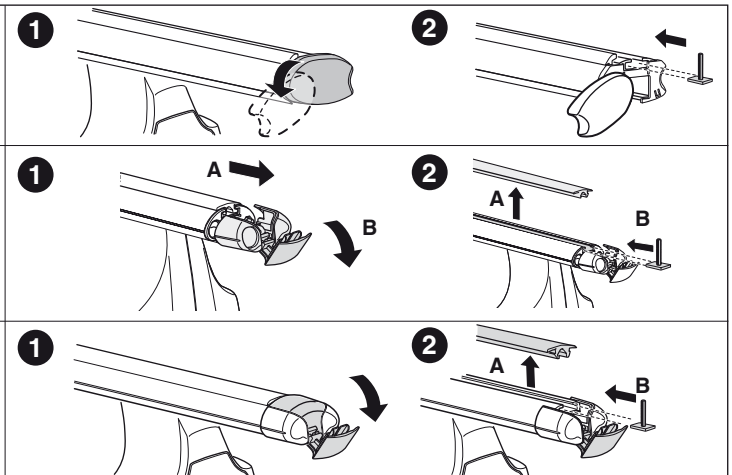
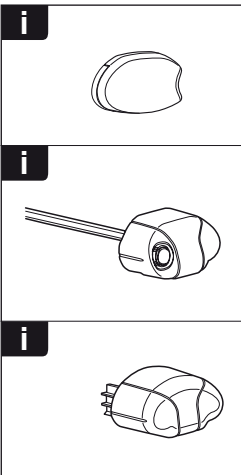
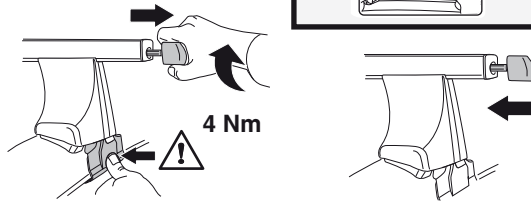
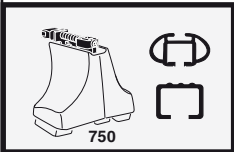
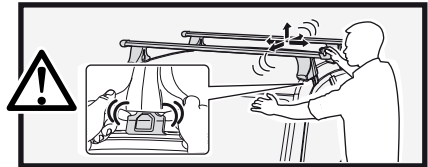
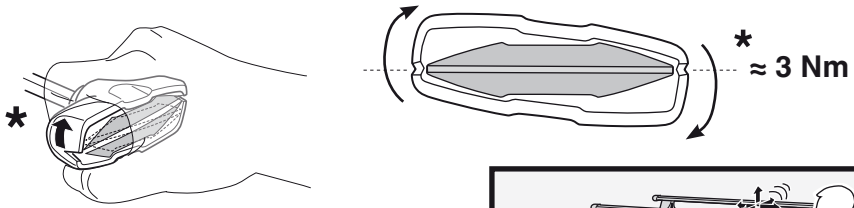
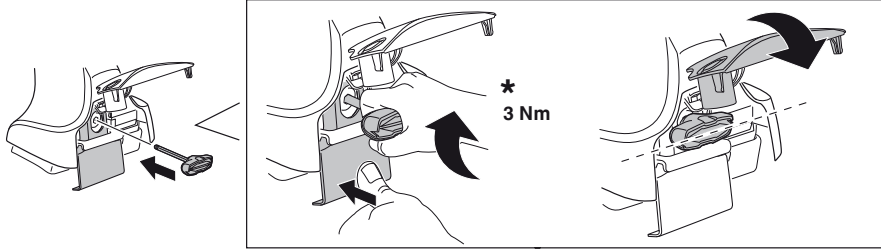
6

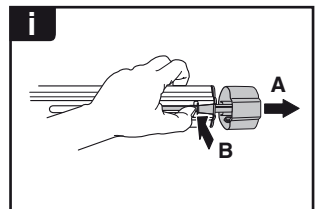
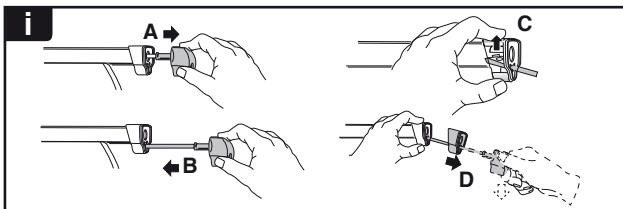
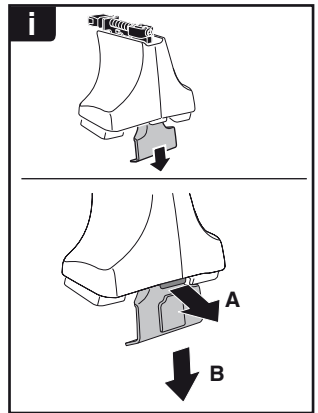
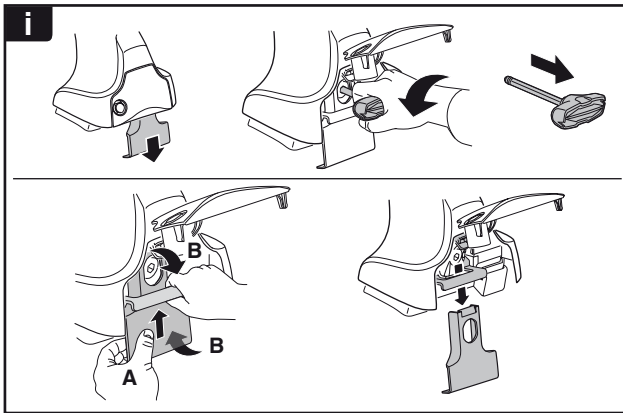
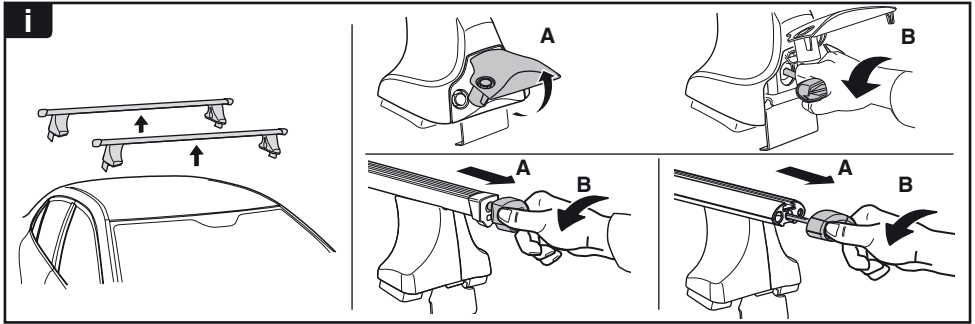

THULE
SWEDEN
**ONE
KEY
SYSTEM**

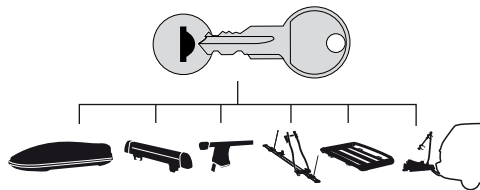

		(x4)
		(x6)
		(x8)
NA		(x10)
EUR		(x12)
ASIA		(x12)

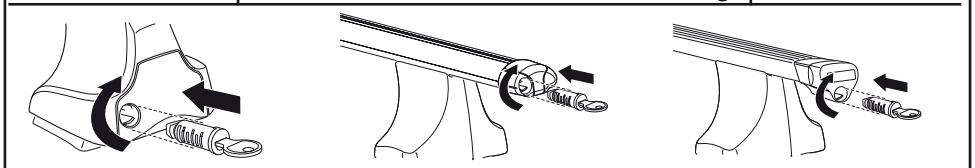

WW ▶ Thule Sweden AB, Box 69, 330 33 Hillerstorp, SWEDEN
NA ▶ Thule Inc., 42 Silvermine Road, Seymour, Connecticut 06483, USA

info@thule.com
customer.service@thule.com

www.thule.com