

Kit 1416

HONDA Civic, 5-dr Hatchback, 06-11*

* without glass roof

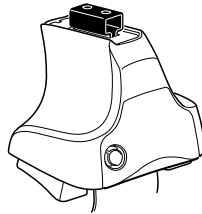

754 Rapid System
480R Rapid Traverse (North America)

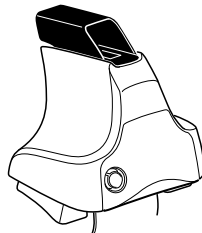
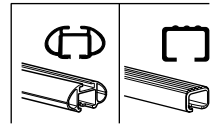

480 Traverse (North America)

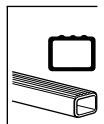

Kit

1



2



754 Rapid System
480R Rapid Traverse
(North America)



x4



x4



x4



480 Traverse
(North America)



x4

3

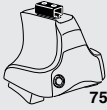

754 Rapid System

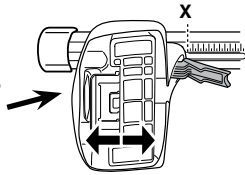

	X
HONDA Civic, 5-dr Hatchback, 06-11	39

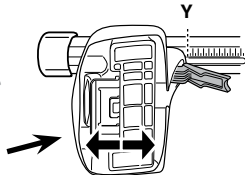

	Y
HONDA Civic, 5-dr Hatchback, 06-11	27,5

3



480R Rapid Traverse



480 Traverse

(North America)

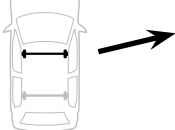

	X inch	X mm
HONDA Civic, 5-dr Hatchback, 06-11	41"	1041 mm

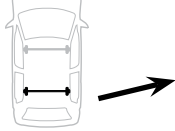
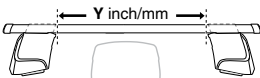

	Y inch	Y mm
HONDA Civic, 5-dr Hatchback, 06-11	36 1/2"	926 mm

4

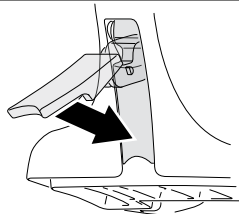

5

HONDA Civic, 5-dr Hatchback, 06-11

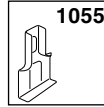
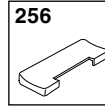
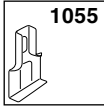
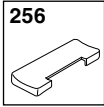
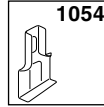
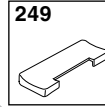
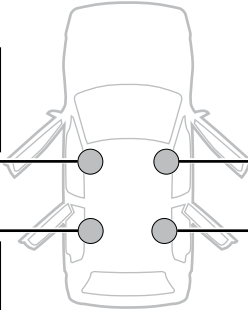
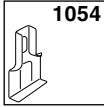
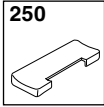

A

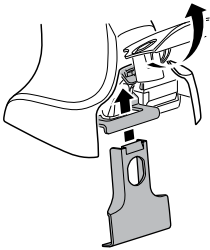

B

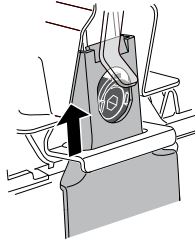

C

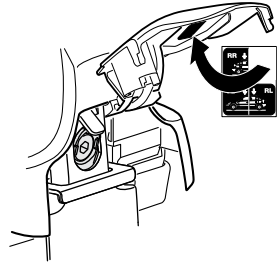
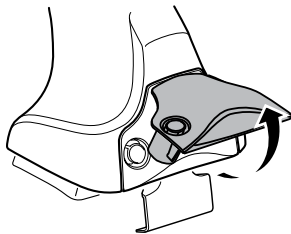
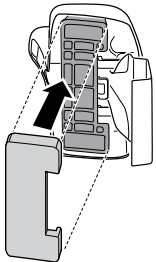
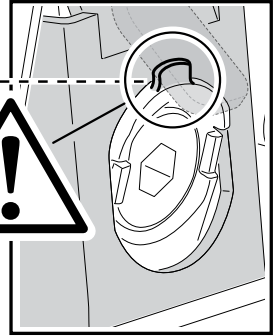
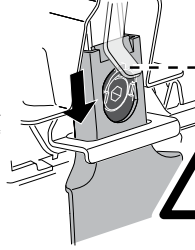

6

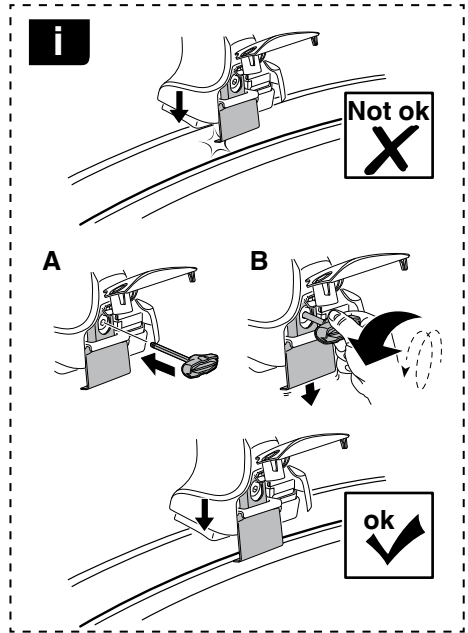
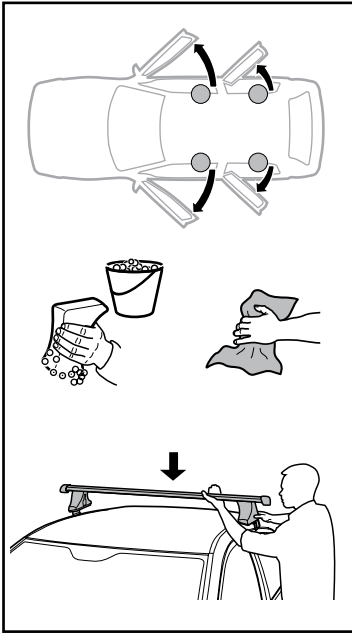

	X mm	Y mm	X inch	Y inch
HONDA Civic, 5-dr Hatchback, 06-11	250 mm	650 mm	9 7/8"	25 5/8"

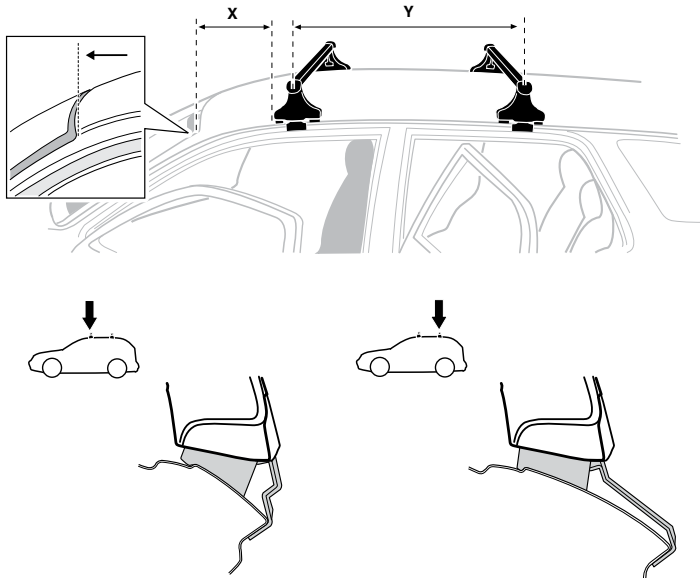

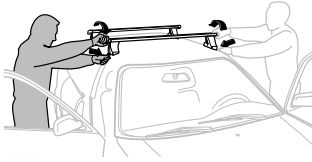
7

GB/US Tighten alternately
D Die Schrauben abwechselnd anziehen
F Serrer alternativement chaque côté
NL Afwisselend aan de linker- en de rechterkant aandraaien
I Alternare il serraggio delle viti
E Apretar alternativamente
PT Aperte alternadamente
S Dra åt växelvis
FIN Kierrä vuorotellen
EST Pinguldage vaheldumisi
LAT Pievelciēt pamiēšus
LIT Užsukinėkite pakaitomis
PL Śruby dokręcaj naprzemiennie
RU Затягивайте попеременно

CZ Pokrétla багаžníka dokręcaj dokręcaj naprzemiennie.
SK Dofahajte striedavo
SLO Privijajte izmenično.
HR Naizmjenično zategnite
HU Egymásról fűggetlenül szorítandó
GR Σφιγίγτες ενολάξ
TR Dönüşümlü sıkın

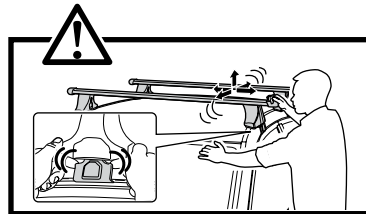
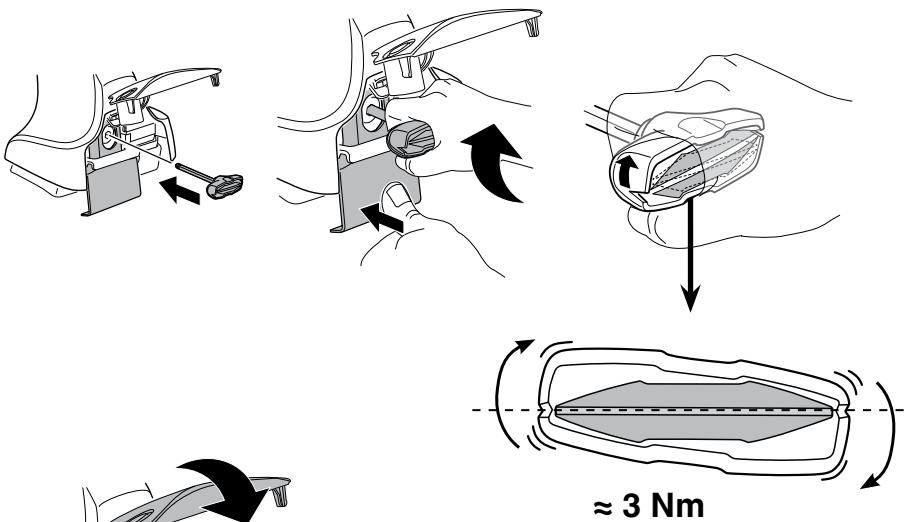
中文 交替拧紧**한국어** 번갈아 가며 조이십시오.**日本語** 交互に締め付けてください。**ไทย** ชั้นในแบบสลับ**8**

x1
17 mm

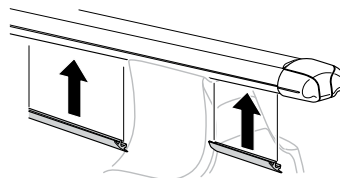
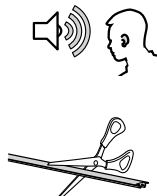



THULE
SWEDEN
**ONE
KEY
SYSTEM**

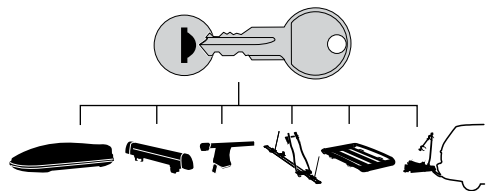

		(x4)
		(x6)
		(x8)
NA		(x10)
EUR		(x12)
ASIA		

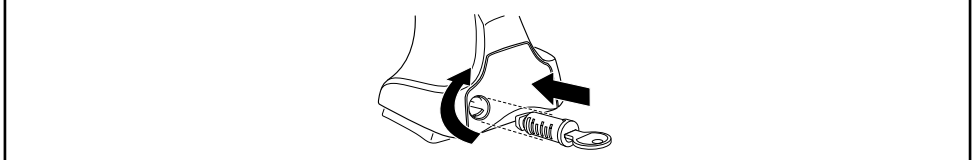

WW ▶ Thule Sweden AB, Box 69, 330 33 Hillerstorp, SWEDEN
NA ▶ Thule Inc., 42 Silvermine Road, Seymour, Connecticut 06483, USA

info@thule.com
customer.service@thule.com

www.thule.com