

Kit 1336

NISSAN Cube, 5-dr MPV, 02- / *09-

NISSAN Cube3 (Cubic), 5-dr MPV, 03-

*North America

480R
754

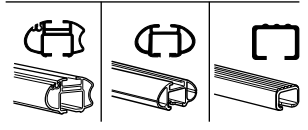
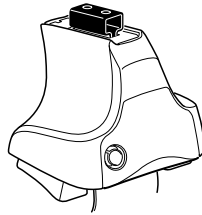

480

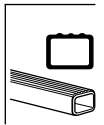
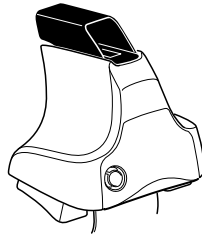

750

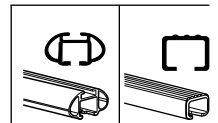
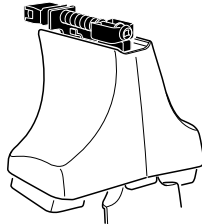

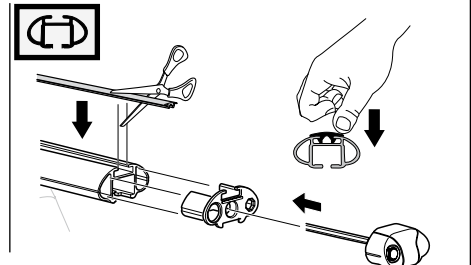
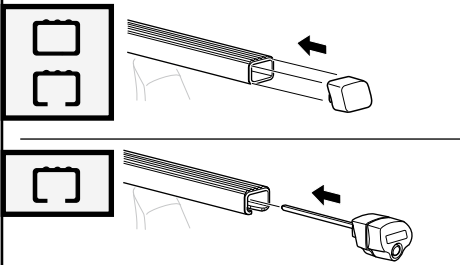
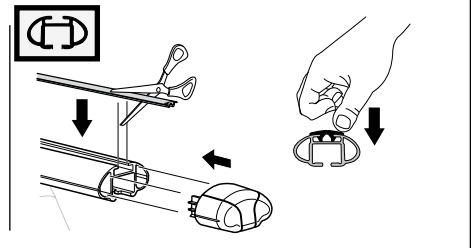
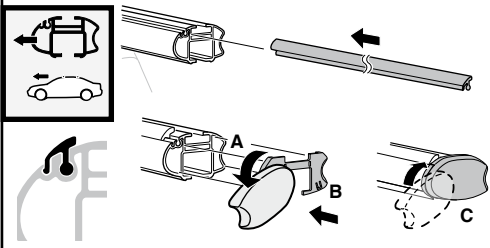
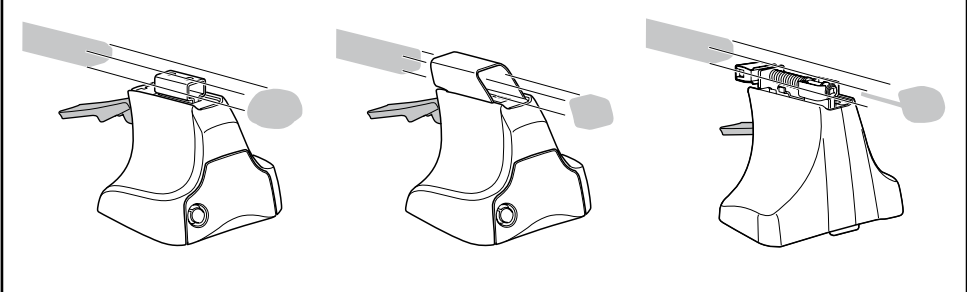
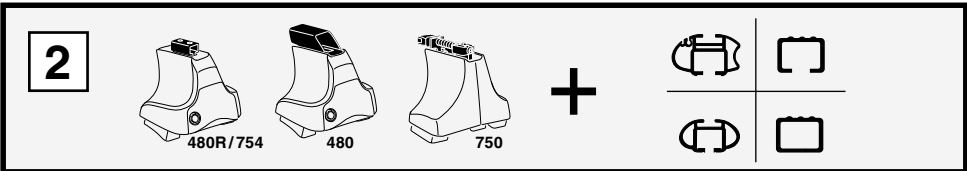
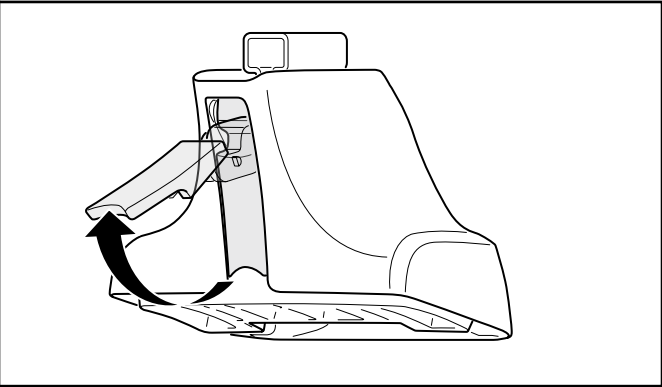
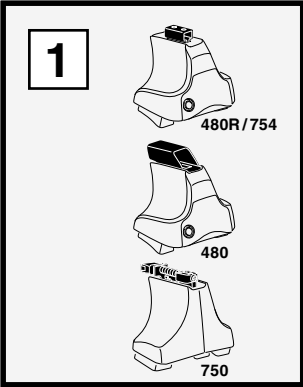

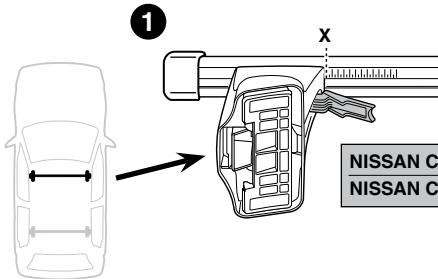
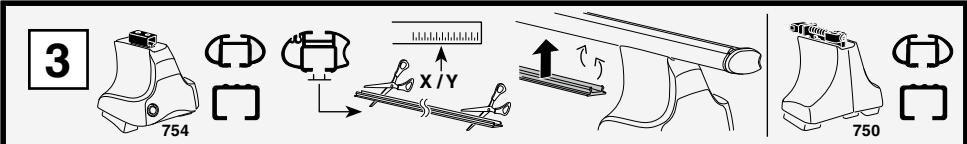

	X
NISSAN Cube, 5-dr MPV, 02- / *09-	64
NISSAN Cube3 (Cubic), 5-dr MPV, 03-	64

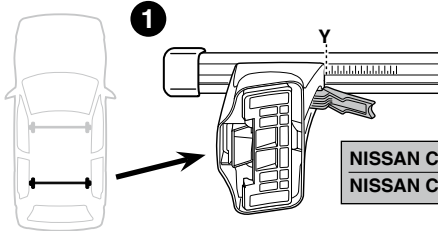
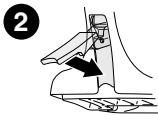

	Y
NISSAN Cube, 5-dr MPV, 02- / *09-	62,5
NISSAN Cube3 (Cubic), 5-dr MPV, 03-	62,5

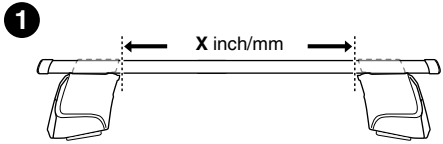
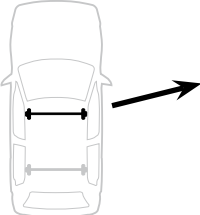
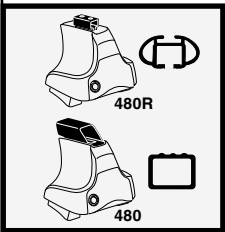
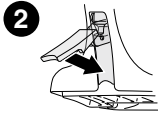

	X inch	X mm
NISSAN Cube, 5-dr MPV, 02- / *09-	50 ⁷ / ₈ "	1291 mm
NISSAN Cube3 (Cubic), 5-dr MPV, 03-	50 ⁷ / ₈ "	1291 mm

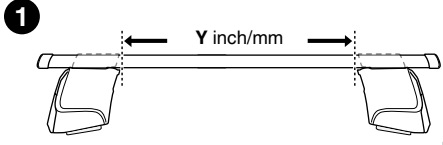
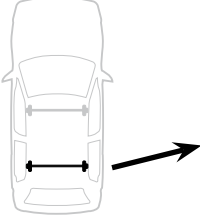
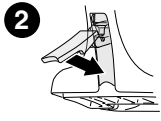

	Y inch	Y mm
NISSAN Cube, 5-dr MPV, 02- / *09-	50 ¹ / ₄ "	1276 mm
NISSAN Cube3 (Cubic), 5-dr MPV, 03-	50 ¹ / ₄ "	1276 mm

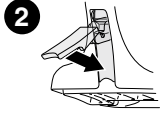

4

NISSAN Cube, 5-dr MPV, 02- / *09-
NISSAN Cube3 (Cubic), 5-dr MPV, 03-

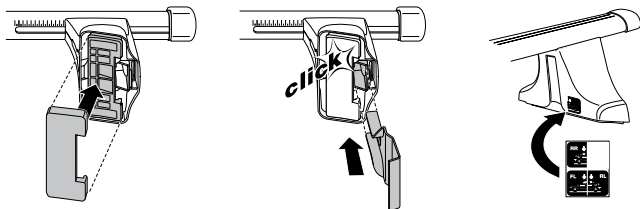
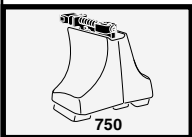
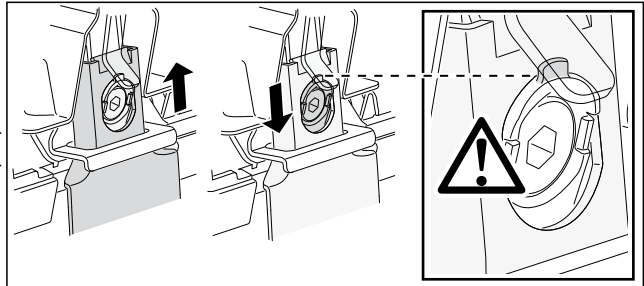
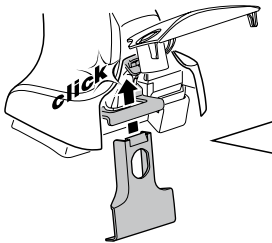
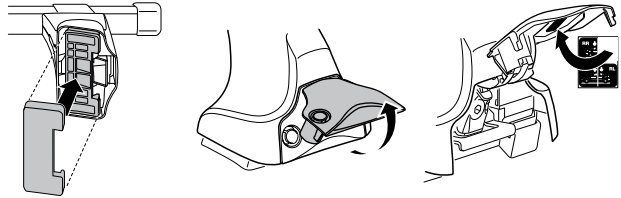
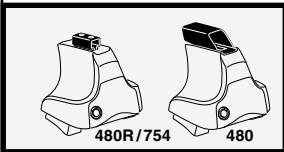
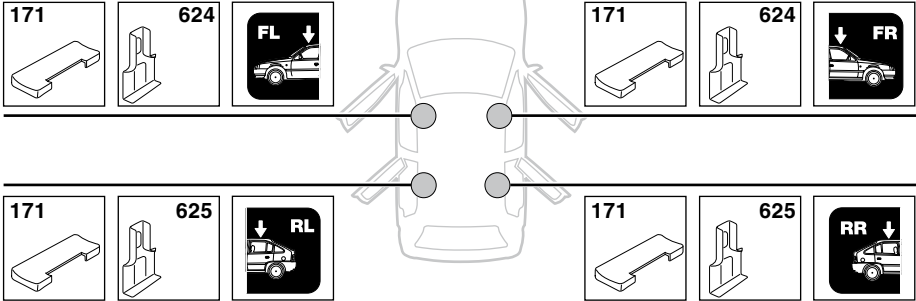

5



	X mm	Y mm	X inch	Y inch
NISSAN Cube , 5-dr MPV, 02- / *09-	545 mm	700 mm	21 1/2"	27 1/2"
NISSAN Cube3 (Cubic) , 5-dr MPV, 03-	545 mm	700 mm	21 1/2"	27 1/2"

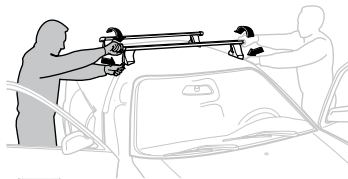
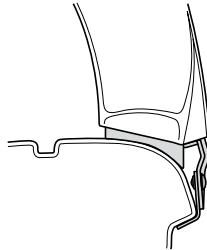
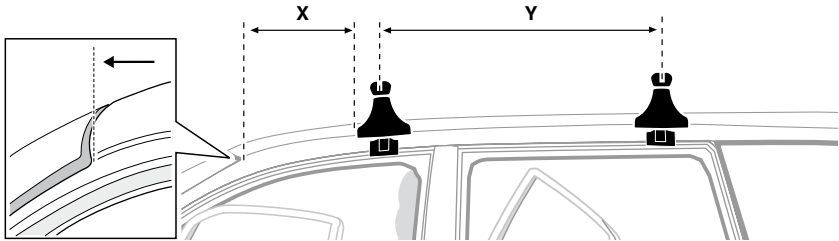

GB/US Tighten alternately

D Die Schrauben abwechselnd anziehen

F Serrer alternativement chaque côté

NL Afwisselend aan de linker- en de rechterkant aandraaien

I Alternare il serraggio delle viti

E Apretar alternativamente

PT Aperte alternadamente

S Dra åt växelvis

FIN Kierrä vuorotellen

EST Pinguldage vaheldumisi

LAT Pielvelciet pamišus

LIT Užsukinėkite pakaitomis

PL Śruby dokręcaj naprzemiennie

RU Затягивайте попеременно

CZ Pokręťta bagażníka dokręcaj dokręcaj naprzemiennie.

SK Doťahujte striedavo

SLO Privijajte izmenično.

HR Naizmjenično zategnite

HU Egymástól függetlenül szorítandó

GR Σφίγγετε εναλλάξ

TR Dönüşümlü sıkın

中文 交替拧紧

한국어 번갈아 가며 조이십시오.

日本語 交互に締め付けてください。

ไทย ชั้้นในแบบสลับ

6



480R/754



480

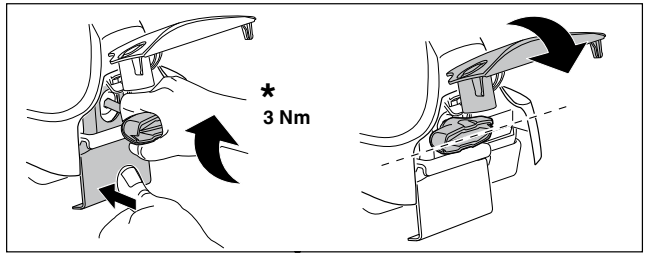

*
3 Nm



*



*
≈ 3 Nm

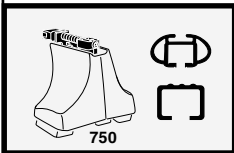
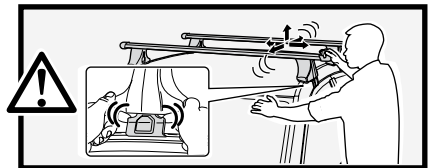

750

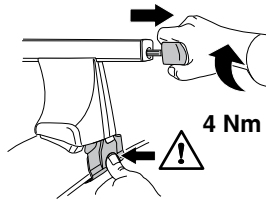

4 Nm

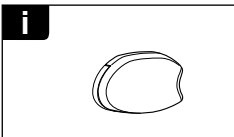
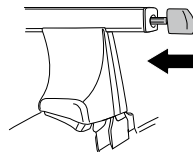

i

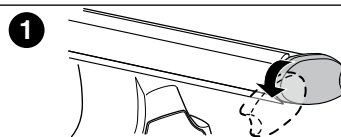

1

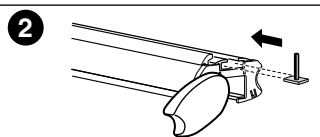

2

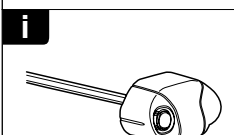

i

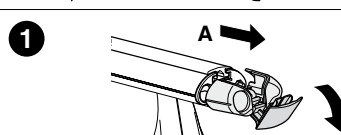

1

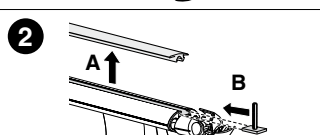

2

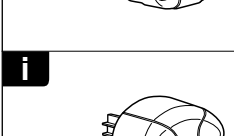

i

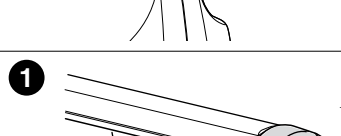

1

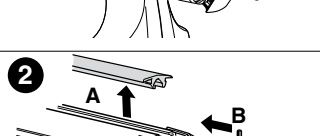

2



THULE
SWEDEN
**ONE
KEY
SYSTEM**



- 544** (x4)
- 596** (x6)
- 588** (x8)
- NA **510** (x10)
- EUR **452** (x12)
- ASIA



WW ▶ Thule Sweden AB, Box 69, 330 33 Hillerstorp, SWEDEN
NA ▶ Thule Inc., 42 Silvermine Road, Seymour, Connecticut 06483, USA

info@thule.com
customer.service@thule.com

www.thule.com