

Kit 3065

BMW 3-series, 4-dr Sedan, 98-01, 02-04

BMW 3-series, 2-dr Coupé, 99-00, 01-05

BMW 3-series, 3-dr Compact, 01-04

BMW 3-series, 5-dr Touring, 00-01, 02-05

BMW 5-series, 4-dr Sedan, 96-00, 01-03

BMW 5-series, 5-dr Touring, 97-00, 01-03

CADILLAC BLS, 4-dr Sedan, 06-

RENAULT Vel Satis, 4-dr Sedan, 02-

SAAB 9-3 Sportsedan, 4-dr Sedan, 03-

SAAB 9-3 Sportcombi, 5-dr Estate, 05-

This Kit is only for vehicles with fixpoint mounting.

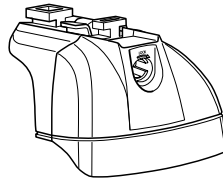

460R
753

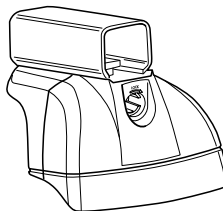

460

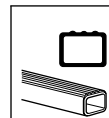

THULE[®]
SWEDEN

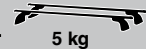

 $xx \text{ kg}$
 $xx \text{ lbs}$



 $+ 5 \text{ kg}$
 11 lbs

$=$

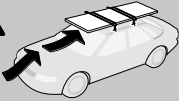
Max.
75kg

Max.
165 lbs





80 km/h
 50 Mph

130 km/h
 80 Mph

40 km/h
 25 Mph

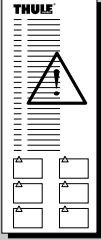
km/h
Mph





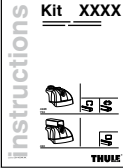

$+$





Kit XXXX



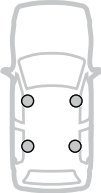

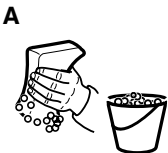



A



B

C

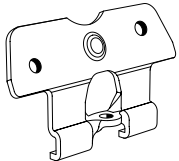

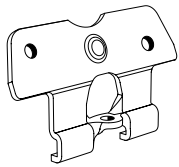



07 x 2



08 x 2

x 1

50939

16 mm x 4

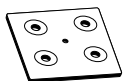
25 mm x 4

x 1

Kit



753



x4



x4



x4



x8

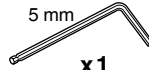

x1



x4



x1

460R

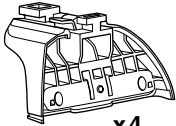

x4



x4



x4



x8

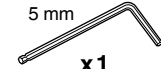

x1



x4

460



x4



x4



x4



x8

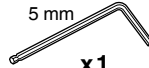

x1



x4

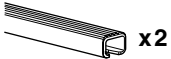

x2



x2

17 mm

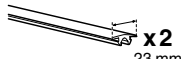

x2

23 mm



x2

23 mm

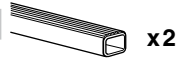

x2

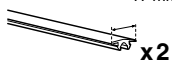

x2

23 mm

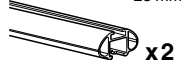

x2

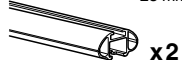

x2

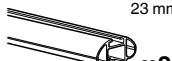

x2



x4



x4



x4

1

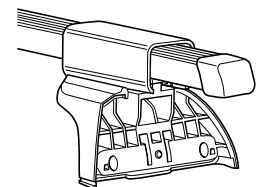
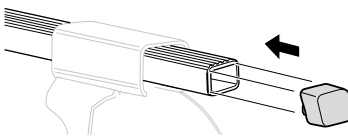
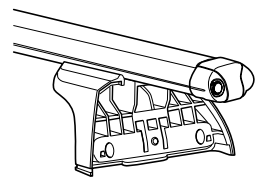
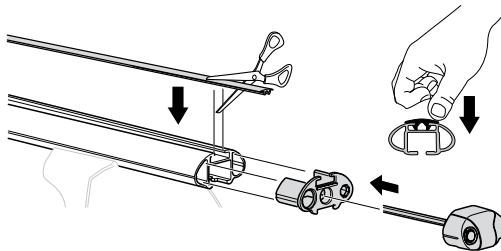
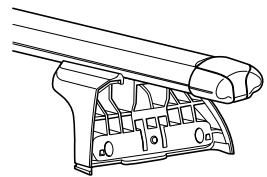
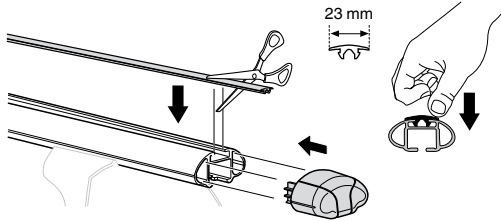
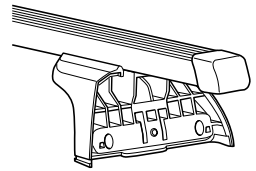
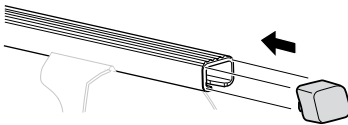
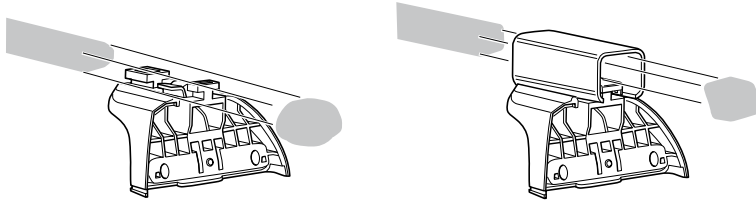
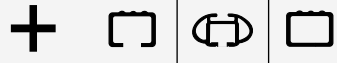
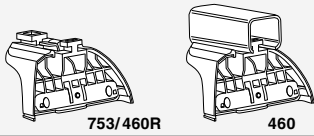

2

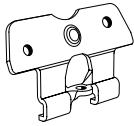

07 x 2

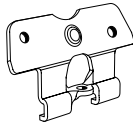

08 x 2

16 mm x 8



x 1

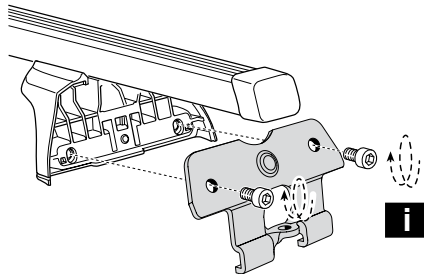
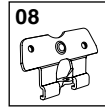
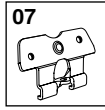
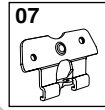
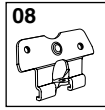

i

GB Only a few turns
D Nur wenige Umdrehungen
F Quelques tours uniquement
NL Slechts enkele slagen
I Solo qualche giro
E Sólo algunas vueltas
PT Noções básicas
S Endast några varv
FIN Vain muutama kierros

EST Ainult mõni pööre
LAT Tikai dažī apgriezieni
LIT Tik keli pasukimai
PL Wystarczy kilka obrotów
RU Достаточно нескольких оборотов
CZ Pouze několik otáček
SK Len niekoľko otáčok
SLO Le nekaj obratov

HR Samo nekoliko okreta
HU Csak néhány fordítás
GR Μόνο μερικές στροφές
TR Yalnız birkaç kez çevirm
中文 只有几个转向
한국어 두 세번만
日本語 数回転のみ
ไทย หมุนเพียงไม่กี่รอบ

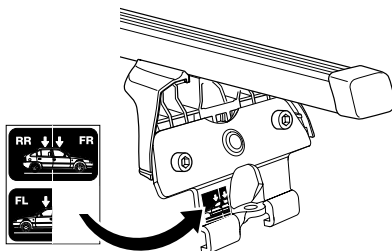

3

**BMW
RENAULT**



**CADILLAC
SAAB**

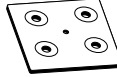
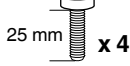

x1

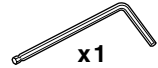

x1

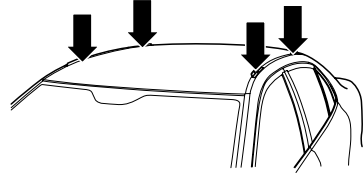

A

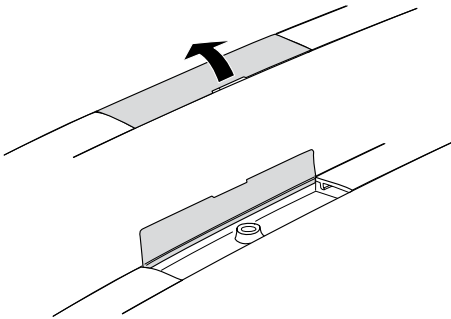

B

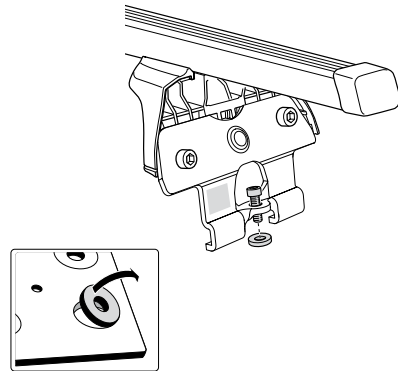

C

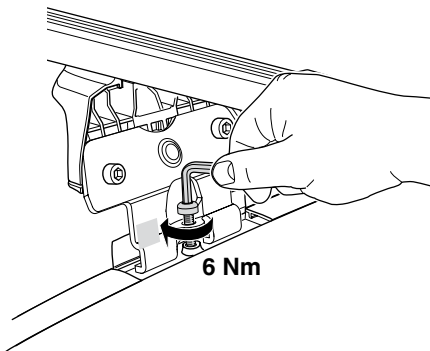

D

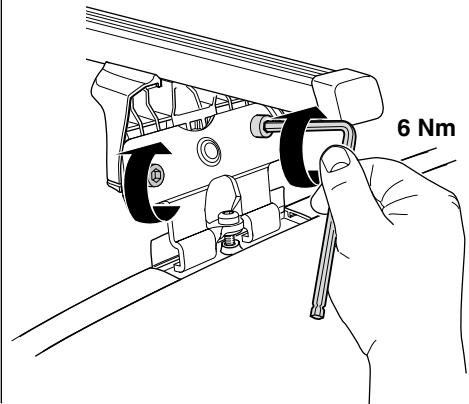

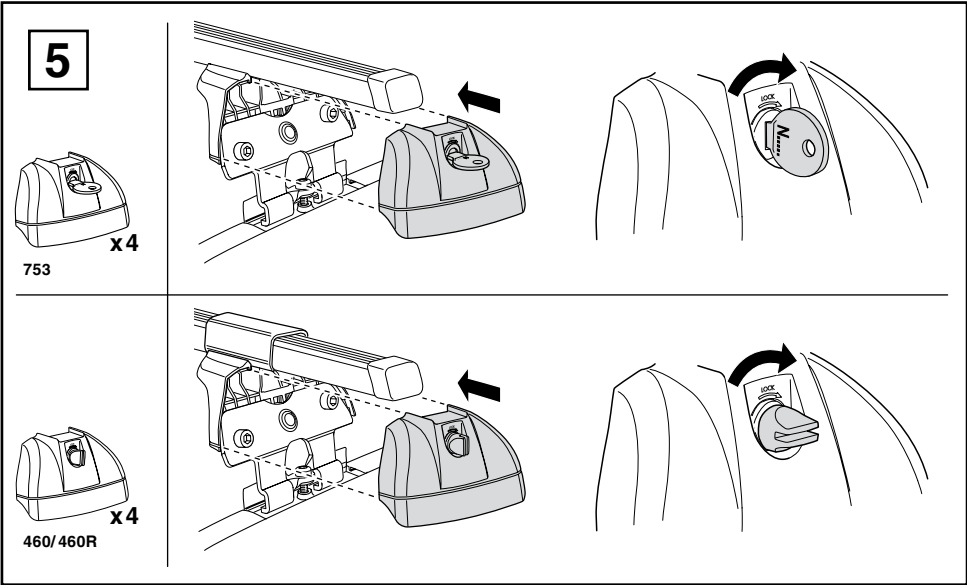
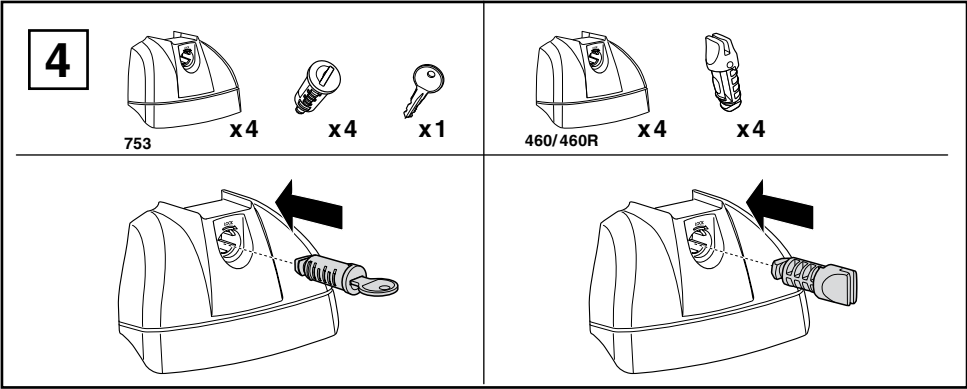

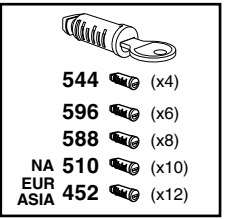
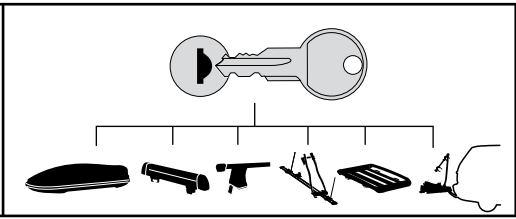
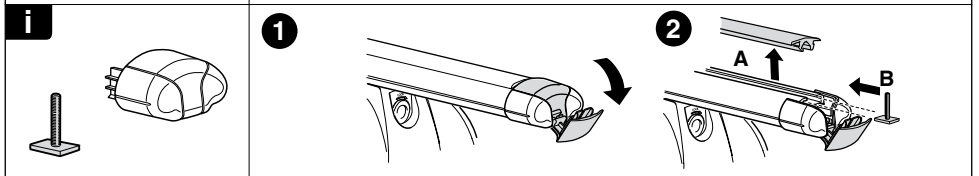
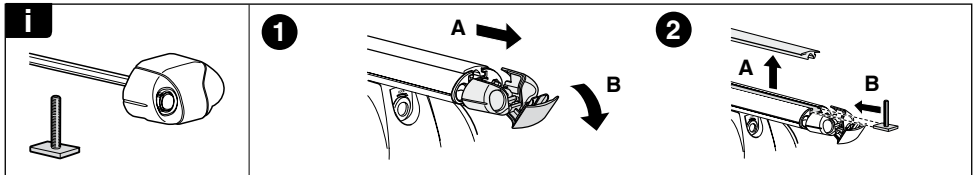
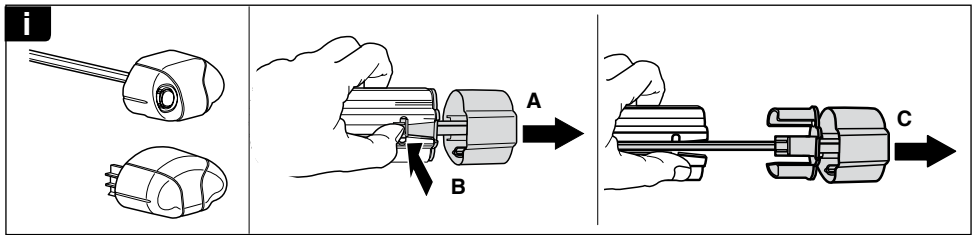
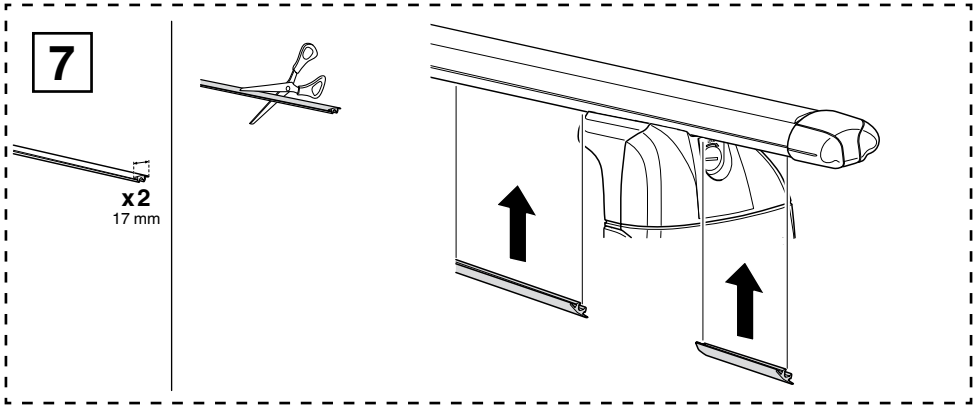

WW ▶ Thule Sweden AB, Box 69, 330 33 Hillerstorp, SWEDEN

NA ▶ Thule Inc., 42 Silvermine Road, Seymour, Connecticut 06483, USA

@ info@thule.com
customer.service@thule.com

www.thule.com