

Kit 3003

SKODA Fabia (Mk.I.), 4-dr Sedan, 01-04, 05-07

SKODA Fabia (Mk.I.), 5-dr Hatchback, 00-04, 05-07

SKODA Octavia I, 4-dr Sedan, 97-99, 00-04

This Kit is only for vehicles with fixpoint mounting.

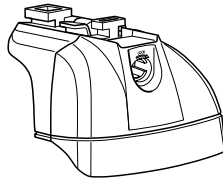

**460R
753**

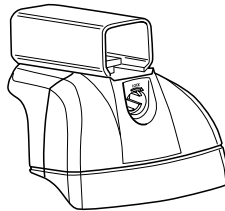
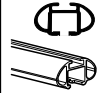

460

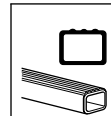

Kit



753



x4



x4



x4



x8

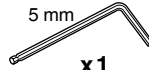

x1



x4



x1

460R

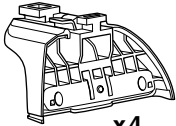

x4



x4



x4



x8

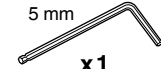

x1



x4

460

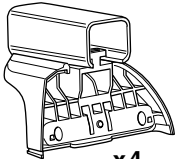

x4



x4



x4



x8



x1



x4

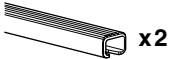
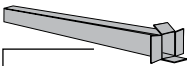

x2



x2

17 mm

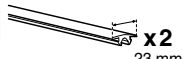

x2

23 mm

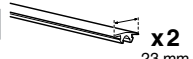

x2

23 mm

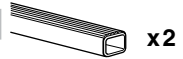

x2

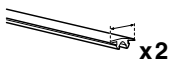

x2

23 mm

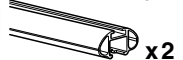

x2

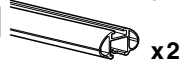

x2

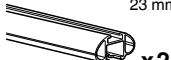

x2



x4



x4



x4

1

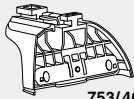

753/460R

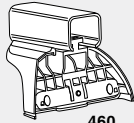

460

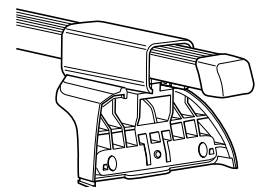
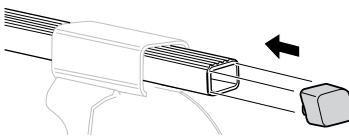
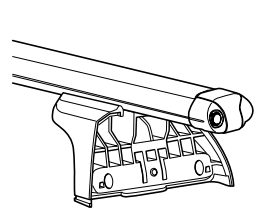
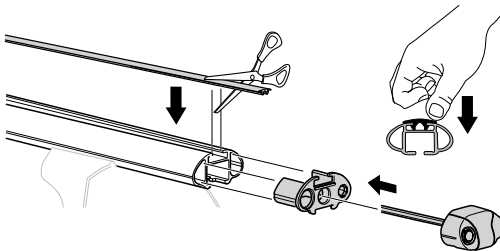
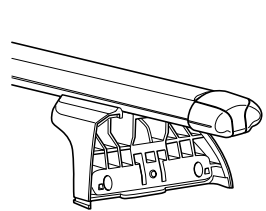
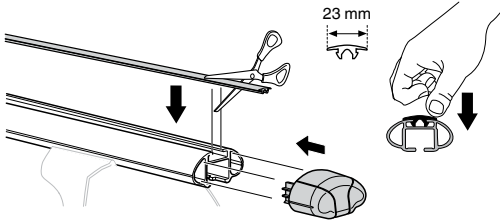
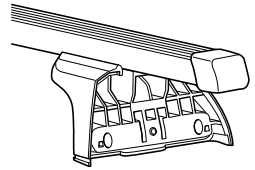
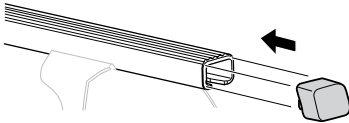
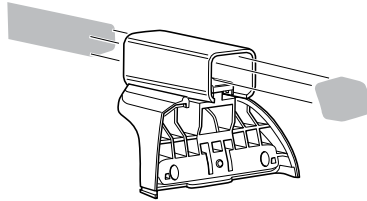
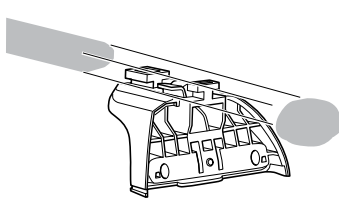

2

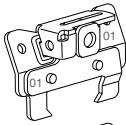

01 / 01 x 2



x 4

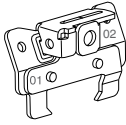

01 / 02 x 2



x 4

16 mm x 8



x 1

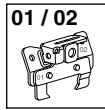

01 / 02



FL ↓

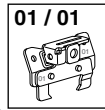

01 / 01



↓ FR

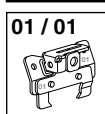

01 / 01

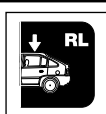

↓ RL

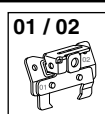

01 / 02

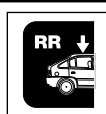

↓ RR

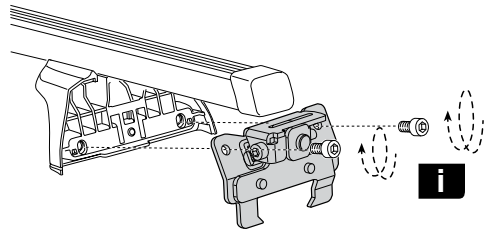
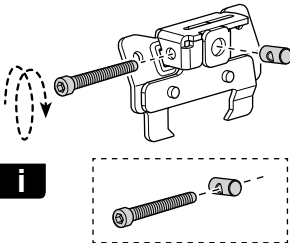

i

GB Only a few turns
D Nur wenige Umdrehungen
F Quelques tours uniquement
NL Slechts enkele slagen
I Solo qualche giro
E Sólo algunas vueltas
PT Noções básicas
S Endast några varv
FIN Vain muutama kierros

EST Ainult mõni pööre
LAT Tikai dažī apgriezieni
LIT Tik keli pasukimai
PL Wystarczy kilka obrotów
RU Достаточно нескольких оборотов
CZ Pouze několik otáček
SK Len niekoľko otáčok
SLO Le nekaj obratov

HR Samo nekoliko okreta
HU Csak néhány fordítás
GR Μόνο μερικές στροφές
TR Yalnız birkaç kez çevirm
中文 只有几个转向
한국어 두 세번만
日本語 数回転のみ
ไทย หมุนเพียงไม่กี่รอบ

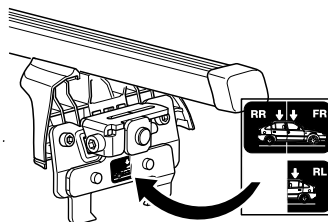

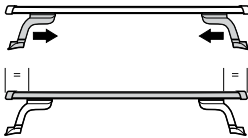
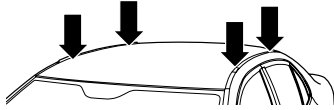
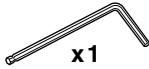
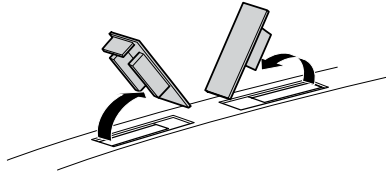
3**A**

- GB** Open carefully with a pointed plastic tool.
D Vorsichtig mittels spitzem Kunststoffwerkzeug öffnen.
F Ouvrir délicatement à l'aide d'un outil pointu en plastique.
NL Open voorzichtig met een spits plastic gereedschap.
I Aprire con cautela utilizzando un oggetto appuntito in plastica.
E Abrir con precaución con una herramienta de plástico puntiaguda.
PT Abrir cuidadosamente com uma ferramenta de plástico pontiaguda.
S Öppnas försiktigt med spetsigt plastverktyg.
FIN Avaa varovasti teräväkärkisellä muovityökallulla.
EST Avage ettevaatlikult terava plastööriistaga.
LAT Atveriet uzmanīgi ar asu plastmasas instrumentu.
LIT Su smailiu plastmasiniu irankiu atsargiai atidarykite.
PL Otwórz zaślepki podważając je ostrożnie ostrym narzędziem.
RU Осторожно откройте острым пластиковым инструментом.
CZ Opatrně otevřete vyznačeným plastovým nástrojem.
SK Otvorte opatrne ostrým plastovým nástrojom.
SLO Uporabite plasticno konico pri odpiranju pokrovkov.
HR Pažljivo otvorite šiljastim plastičnim alatom.
HU Óvatosan nyisd ki a megjelölt pontot egy műanyag szerszámmal.
GR Ανοίξτε προσεκτικά με ένα αιχμηρό πλαστικό εργαλείο.
TR Uçlu bir plastik aletle dikkatlice açın.

中文 用尖头的塑料工具小心启开。

한국어 뾰족한 플라스틱 도구로 조심스럽게 여십시오.

日本語 突出部のあるプラスチックツールを使用して慎重に開けてください

ไทย เปิดอย่างระมัดระวังด้วยเครื่องมือพลาสติกปลายแหลม.

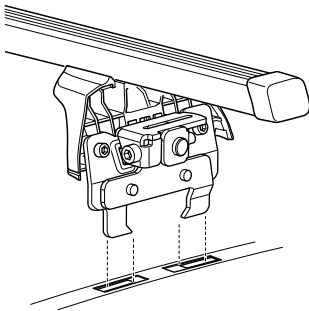
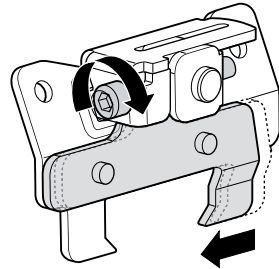
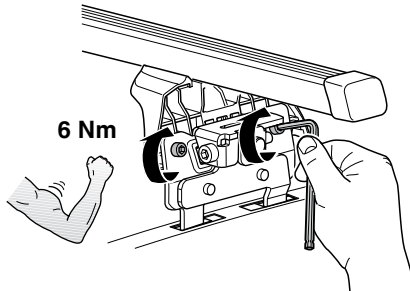
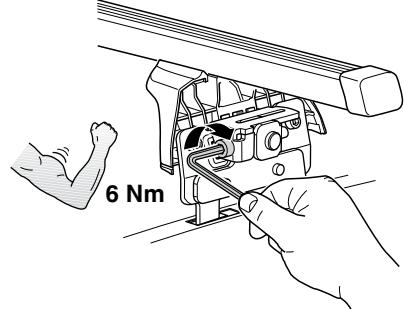
B**C****D****E**

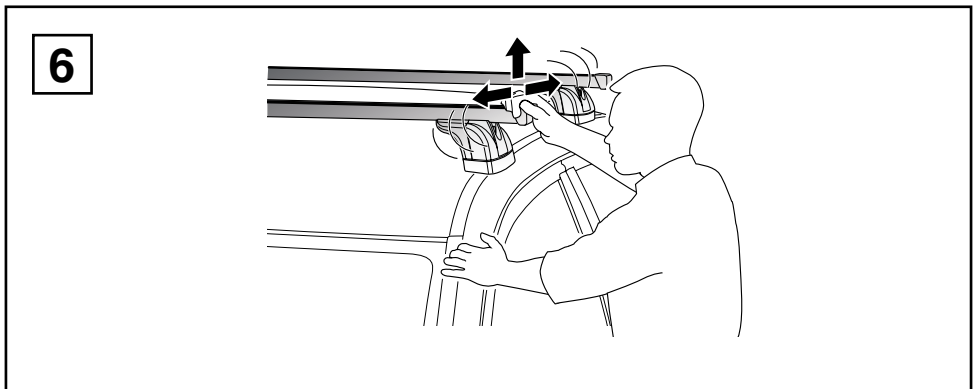
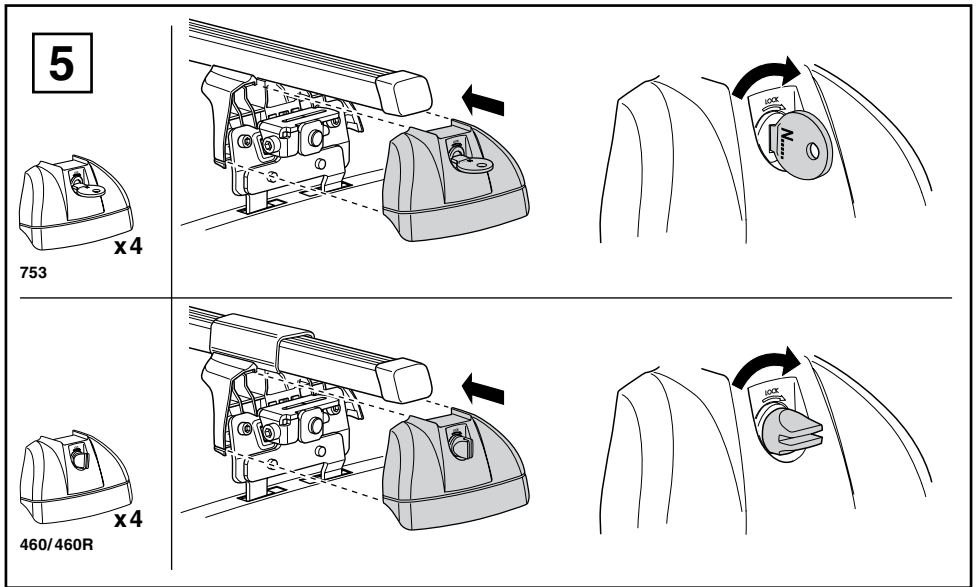
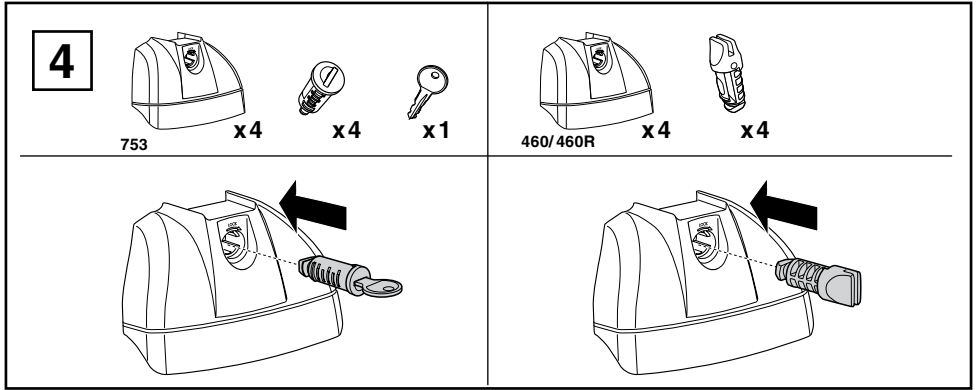

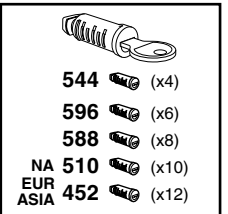
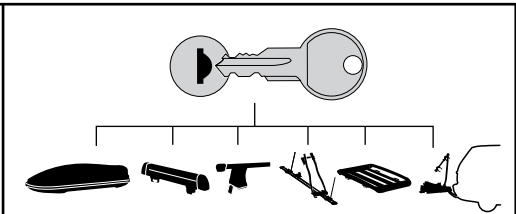
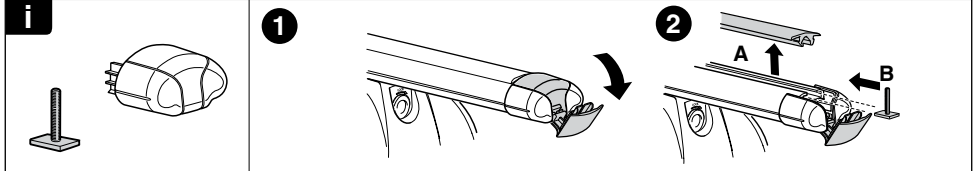
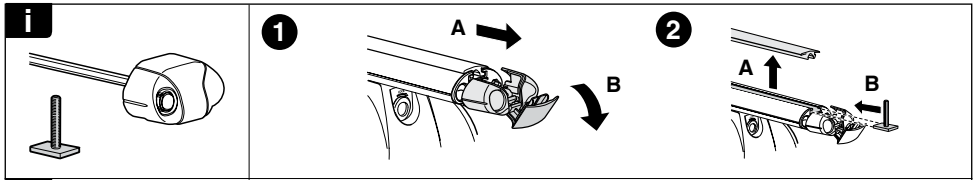
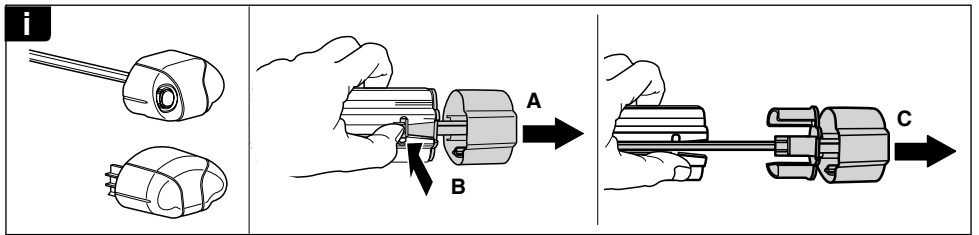
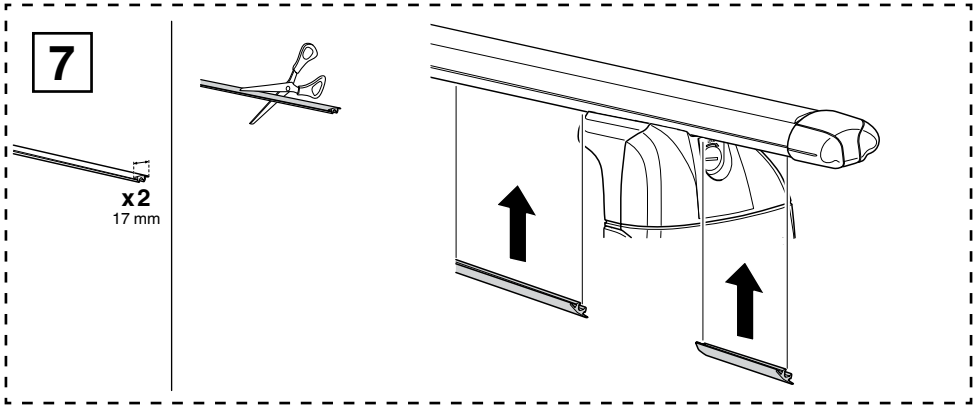

WW ▶ Thule Sweden AB, Box 69, 330 33 Hillerstorp, SWEDEN

NA ▶ Thule Inc., 42 Silvermine Road, Seymour, Connecticut 06483, USA

@ info@thule.com
customer.service@thule.com

www.thule.com