

Kit 1456

LAND ROVER Range Rover Sport, 5-dr SUV, 04-09, 10-

480R
754

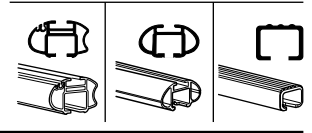
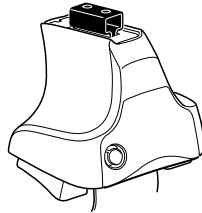

480

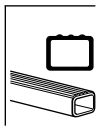
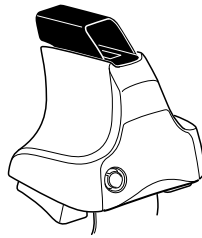

750

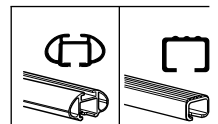
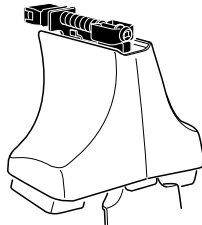

x2 x2 x2 x4	x2	x2 x2 x4 x4	x2 x2	x2

Kit



3

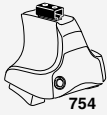

754

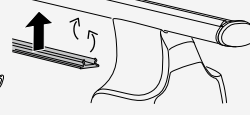
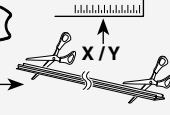

750



1

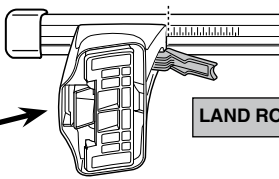
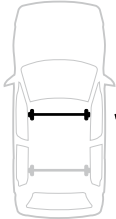

2

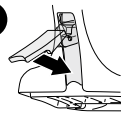

	X
LAND ROVER Range Rover Sport, 5-dr SUV, 04-09,10-	59.5

1

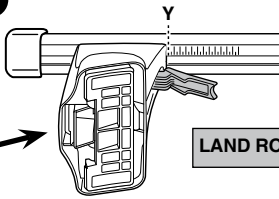

2

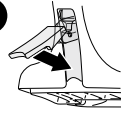

	Y
LAND ROVER Range Rover Sport, 5-dr SUV, 04-09,10-	59



480R

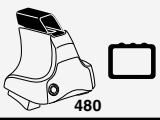

480

1

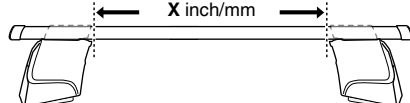
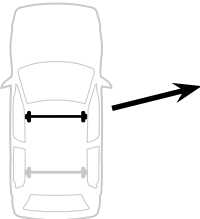

2

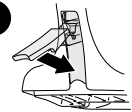

	X inch	X mm
LAND ROVER Range Rover Sport, 5-dr SUV, 04-09,10-	49"	1246 mm

1

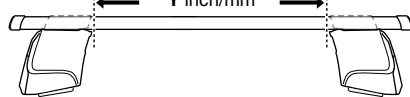
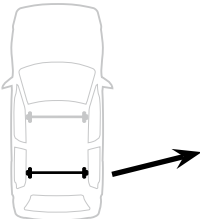

2

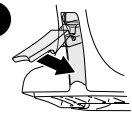

	Y inch	Y mm
LAND ROVER Range Rover Sport, 5-dr SUV, 04-09,10-	48 7/8"	1241 mm

4

LAND ROVER Range Rover Sport, 5-dr SUV, 04-09,10-

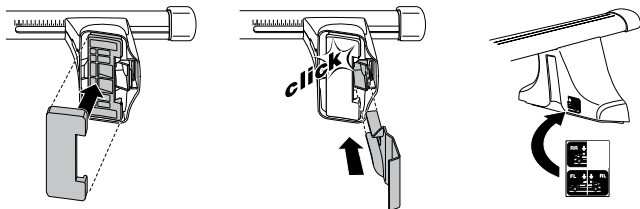
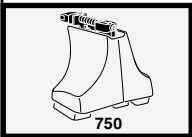
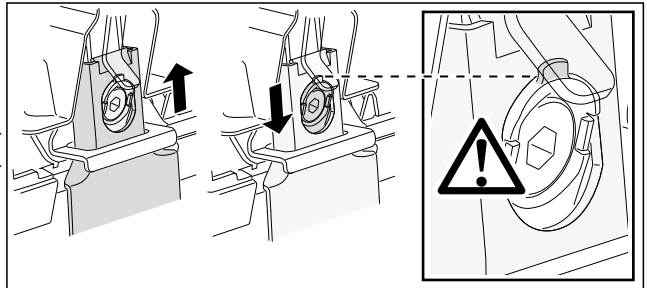
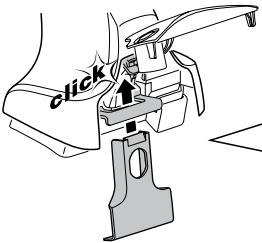
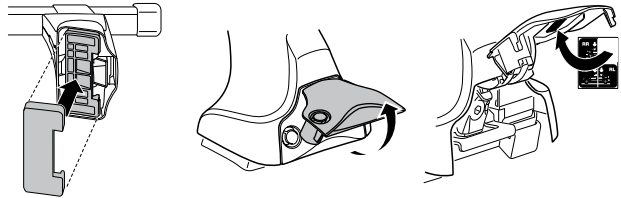
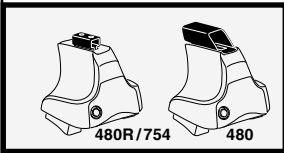
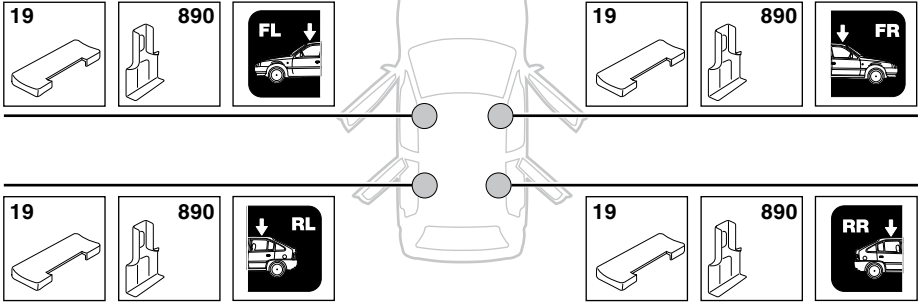

5



	X mm	Y mm	X inch	Y inch
LAND ROVER Range Rover Sport, 5-dr SUV, 04-09, 10-	310 mm	700 mm	12 1/4"	27 1/2"

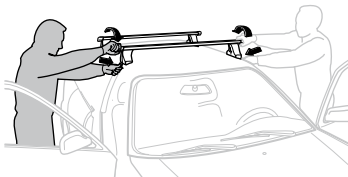
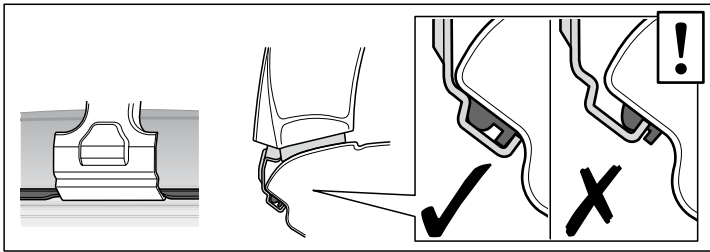
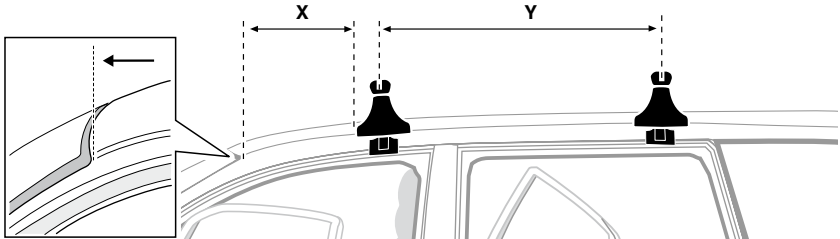

GB/US Tighten alternately

D Die Schrauben abwechselnd anziehen

F Serrer alternativement chaque côté

NL Afwisselend aan de linker- en de rechterkant aandraaien

I Alternare il serraggio delle viti

E Serrare alternativamente

PT Aperte alternadamente

S Dra åt växelvis

FIN Kierrä vuorotellen

EST Pinguldage vaheldumisi

LAT Pielieciet pamišus

LIT Užsukinėkite pakaitomis

PL Śruby dokręcaj naprzemiennie

RU Затягивайте попеременно

CZ Pokręťta bagażníka dokręcaj dokręcaj naprzemiennie.

SK Doťahujte striedavo

SLO Privijajte izmenično.

HR Naizmjenično zategnite

HU Egymástól függetlenül szorítandó

GR Σφιγγετε εναλλάξ

TR Dönüşümlü sıkın

中文 交替拧紧

한국어 번갈아 가며 조이십시오.

日本語 交互に締め付けてください。

ไทย ชันโนแบบสลับ

6



480R/754



480



*
3 Nm



*



*
≈ 3 Nm

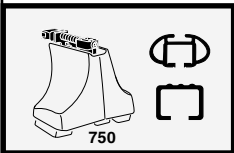

750

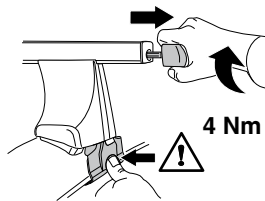

4 Nm

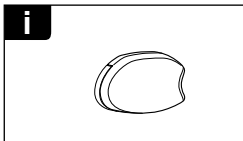
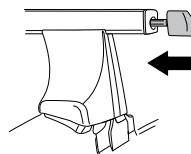

i

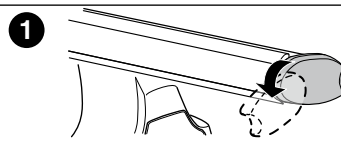

1

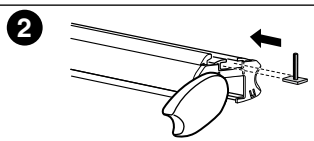

2

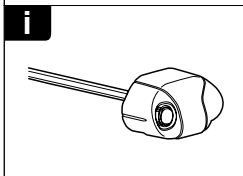

i

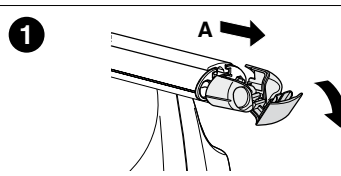

1

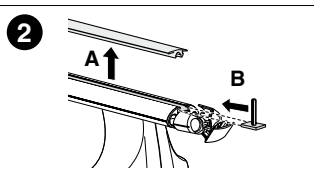

2

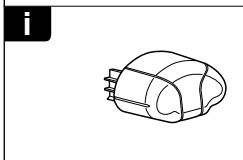

i

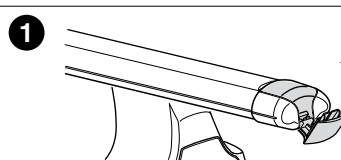

1

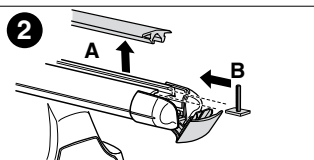

2

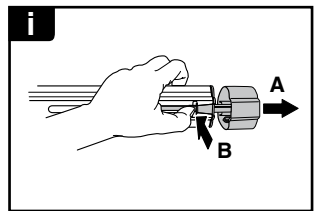
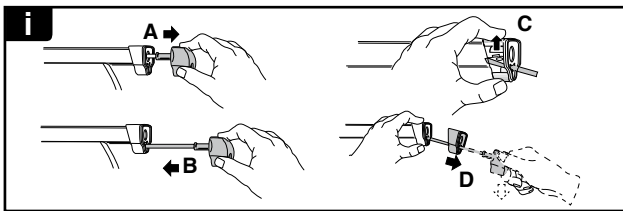
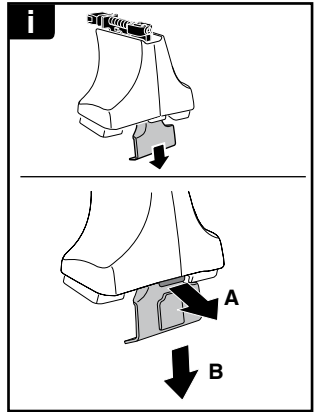
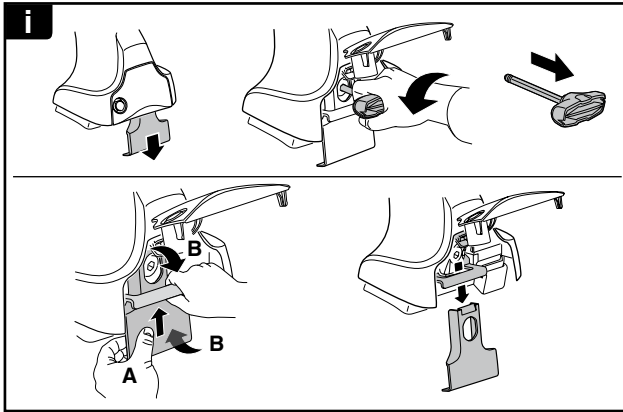

THULE
SWEDEN
**ONE
KEY
SYSTEM**



		544	(x4)
		596	(x6)
		588	(x8)
NA		510	(x10)
EUR		452	(x12)
ASIA			

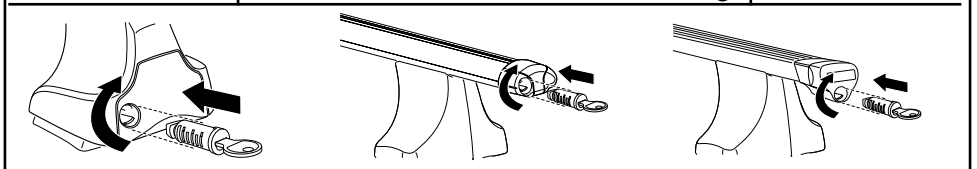

WW ▶ Thule Sweden AB, Box 69, 330 33 Hillerstorp, SWEDEN
NA ▶ Thule Inc., 42 Silvermine Road, Seymour, Connecticut 06483, USA

info@thule.com
customer.service@thule.com

www.thule.com