

# Kit 1475

HYUNDAI H-1, 5-dr Van, 08-\*

HYUNDAI iLoad, 5-dr Van, 08-\*\*

HYUNDAI iMax, 5-dr Bus, 08-\*\*

HYUNDAI Starex, 5-dr Van, 08-\*

\* with dual sliding doors

\*\* with dual sliding doors (Asia)

480R  
754

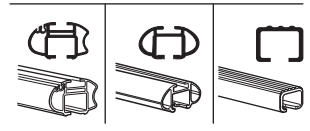
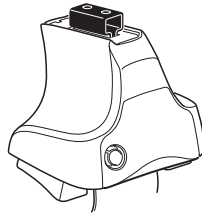

480

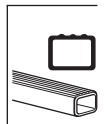
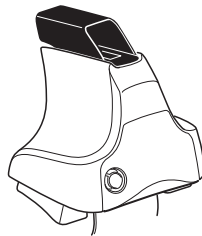

750

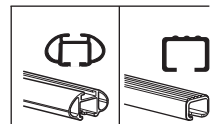
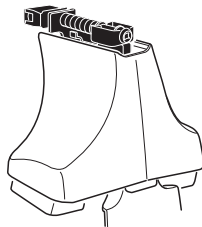

**Kit**

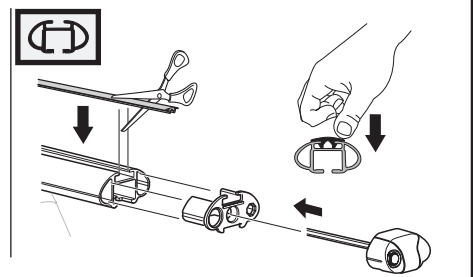
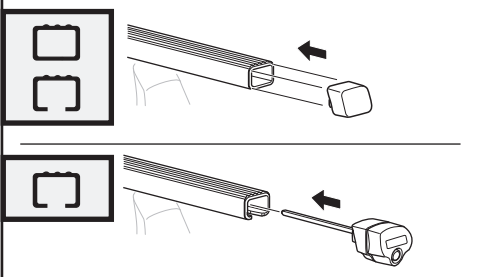
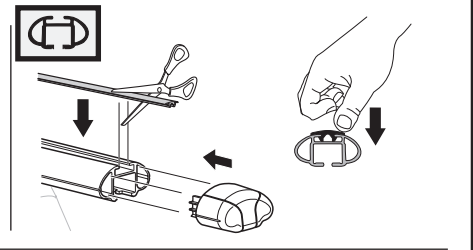
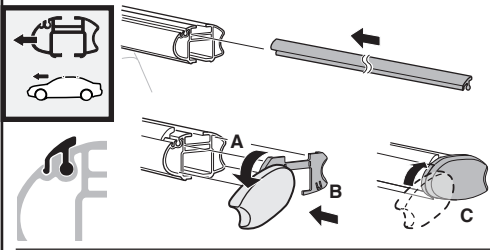
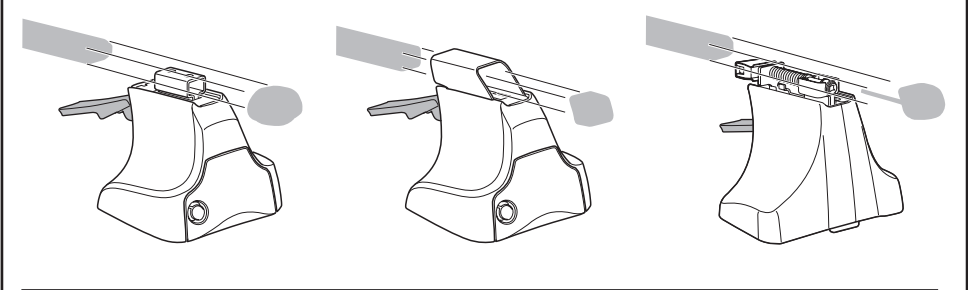
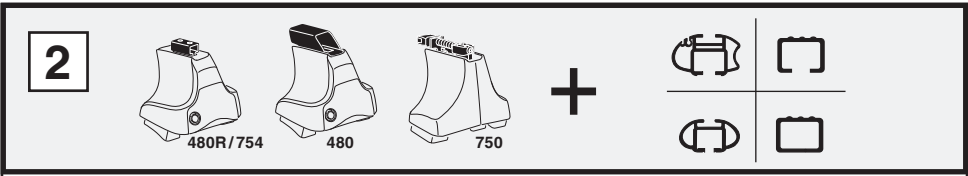
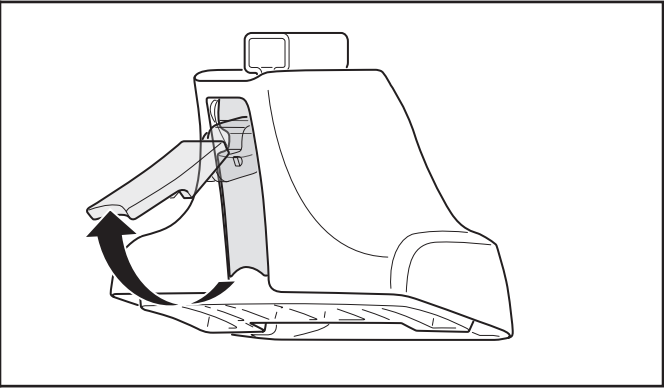
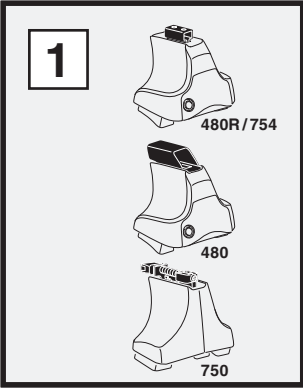

3



754

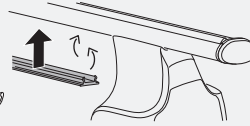
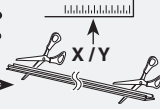

750

1

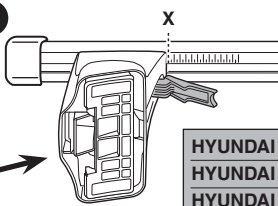
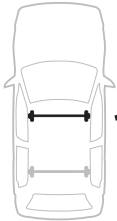

2

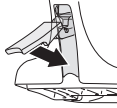

	X
HYUNDAI H-1, 5-dr Van, 08-	54,5
HYUNDAI iLoad, 5-dr Van, 08-	54,5
HYUNDAI iMax, 5-dr Bus, 08-	54,5
HYUNDAI Starex, 5-dr Van, 08-	54,5

1

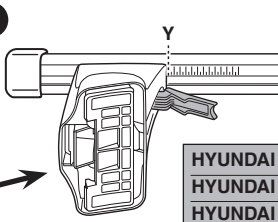

2



	Y
HYUNDAI H-1, 5-dr Van, 08-	53,5
HYUNDAI iLoad, 5-dr Van, 08-	53,5
HYUNDAI iMax, 5-dr Bus, 08-	53,5
HYUNDAI Starex, 5-dr Van, 08-	53,5



480R



480

1

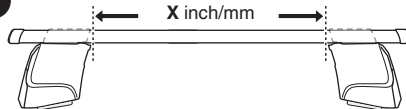

2

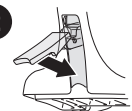

	X inch	X mm
HYUNDAI H-1, 5-dr Van, 08-	47 1/8"	1196 mm
HYUNDAI iLoad, 5-dr Van, 08-	47 1/8"	1196 mm
HYUNDAI iMax, 5-dr Bus, 08-	47 1/8"	1196 mm
HYUNDAI Starex, 5-dr Van, 08-	47 1/8"	1196 mm

1

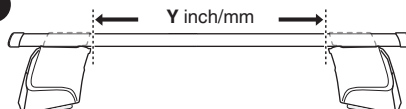

2

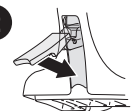

	Y inch	Y mm
HYUNDAI H-1, 5-dr Van, 08-	46 3/4"	1186 mm
HYUNDAI iLoad, 5-dr Van, 08-	46 3/4"	1186 mm
HYUNDAI iMax, 5-dr Bus, 08-	46 3/4"	1186 mm
HYUNDAI Starex, 5-dr Van, 08-	46 3/4"	1186 mm

# 4

HYUNDAI H-1, 5-dr Van, 08-  
 HYUNDAI iLoad, 5-dr Van, 08-  
 HYUNDAI iMax, 5-dr Bus, 08-  
 HYUNDAI Starex, 5-dr Van, 08-

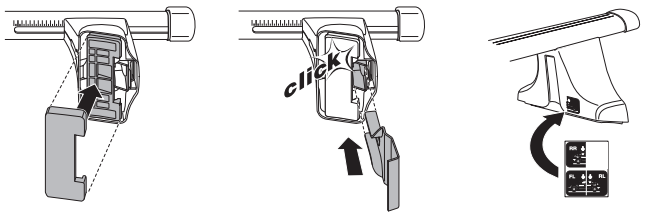
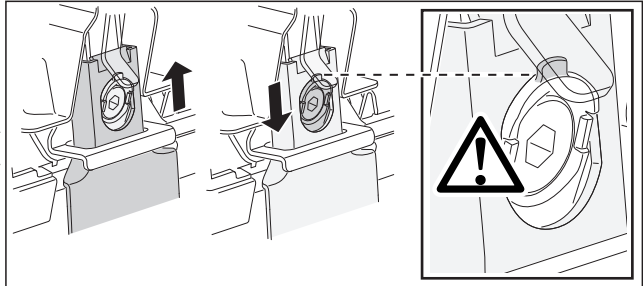
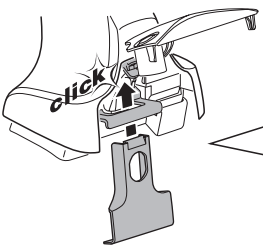
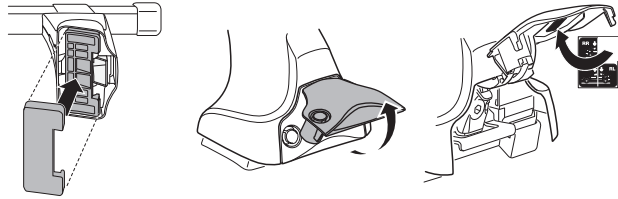
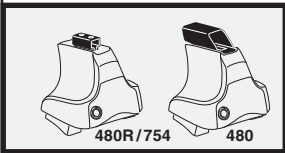
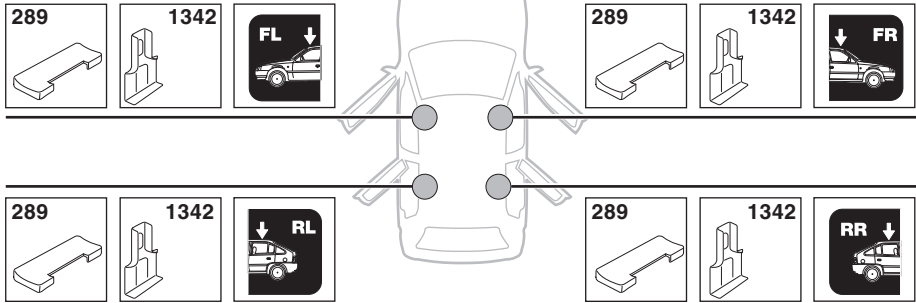

5

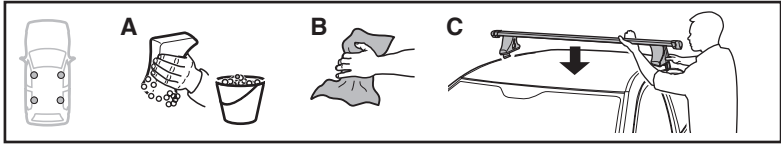

	X mm	Y mm	X inch	Y inch
<b>HYUNDAI H-1</b> , 5-dr Van, 08–	850 mm	700 mm	33 1/2"	27 1/2"
<b>HYUNDAI iLoad</b> , 5-dr Van, 08–	850 mm	700 mm	33 1/2"	27 1/2"
<b>HYUNDAI iMax</b> , 5-dr Bus, 08–	850 mm	700 mm	33 1/2"	27 1/2"
<b>HYUNDAI Starex</b> , 5-dr Van, 08–	850 mm	700 mm	33 1/2"	27 1/2"

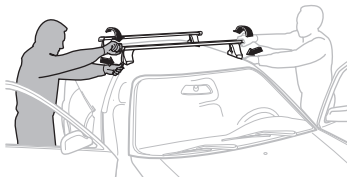
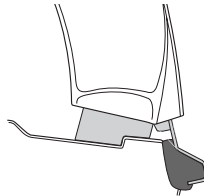
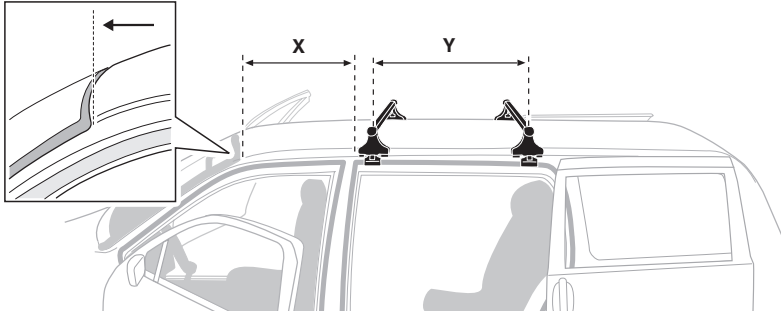

**GB/US** Tighten alternately

**D** Die Schrauben abwechselnd anziehen

**F** Serrer alternativement chaque côté

**NL** Afwisselend aan de linker- en de rechterkant aandraaien

**I** Alternare il serraggio delle viti

**E** Serrare alternativamente

**PT** Aperte alternadamente

**S** Dra åt växelvis

**FIN** Kierrä vuorotellen

**EST** Pinguldage vaheldumisi

**LAT** Pieveļciet pamišus

**LIT** Užsukinėkite pakaitomis

**PL** Śruby dokręcaj naprzemiennie

**RU** Затягивайте попеременно

**CZ** Pokręťta bagażníka dokręcaj dokręcaj naprzemiennie.

**SK** Doťahujte striedavo

**SLO** Privijajte izmenično.

**HR** Naizmjenično zategnite

**HU** Egymástól függetlenül szorítandó

**GR** Σφιγγετε εναλλάξ

**TR** Dönüşümlü sıkın

**中文** 交替拧紧

**한국어** 번갈아 가며 조이십시오.

**日本語** 交互に締め付けてください。

**ไทย** ชันโนแบบสลับ

6



480R/754



480

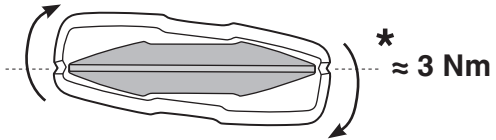
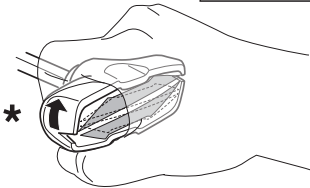
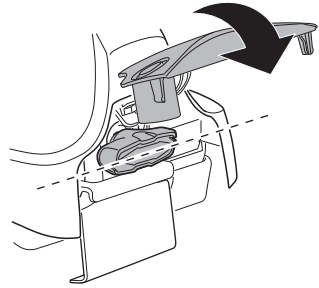
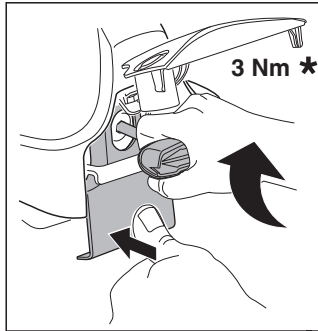
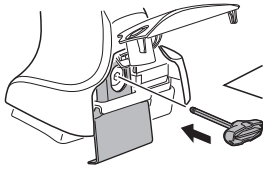

750

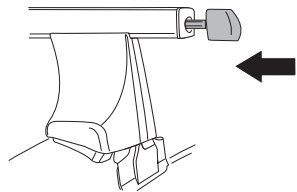
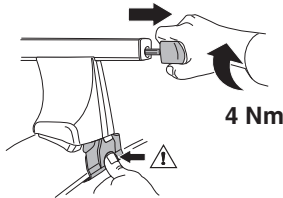

1



2

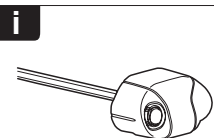
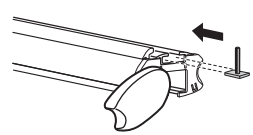

1

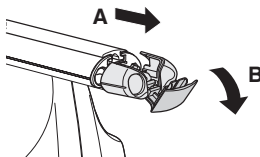

2

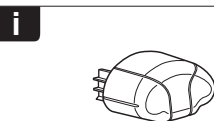
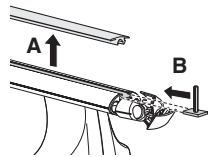

1

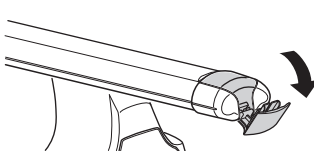

2

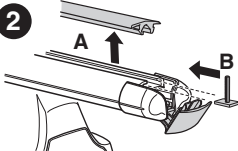

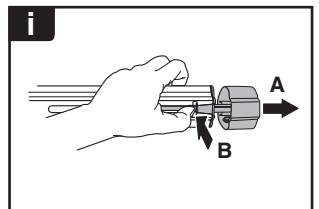
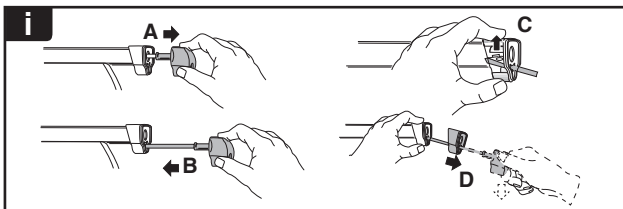
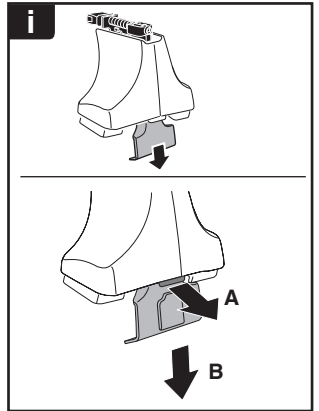
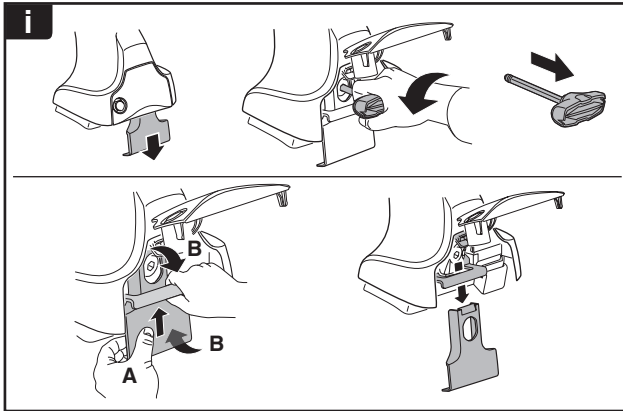
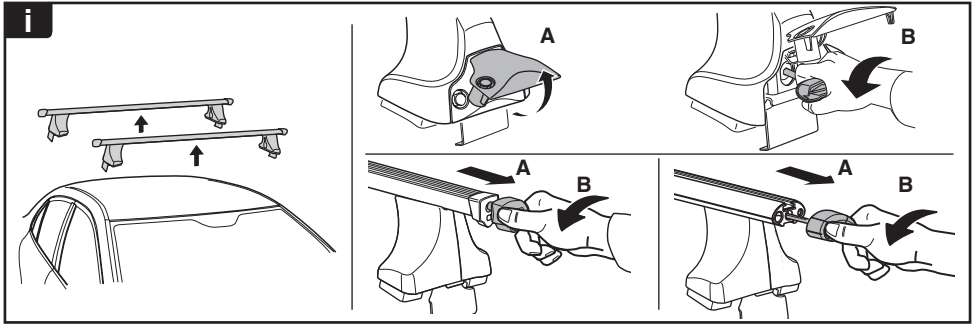

**THULE**  
SWEDEN  
**ONE  
KEY  
SYSTEM**

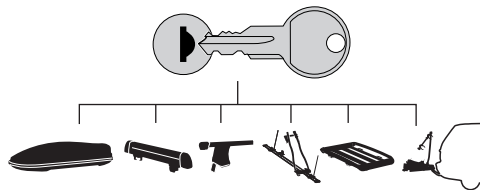

- 544 (x4)
- 596 (x6)
- 588 (x8)
- NA 510 (x10)
- EUR 452 (x12)
- ASIA

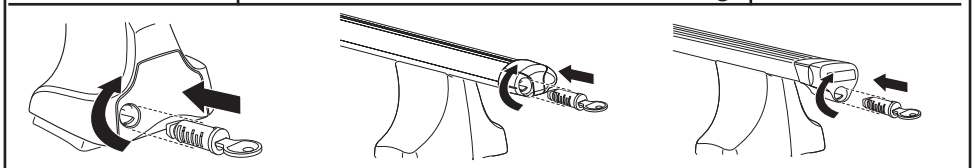

WW ▶ Thule Sweden AB, Box 69, 330 33 Hillerstorp, SWEDEN  
NA ▶ Thule Inc., 42 Silvermine Road, Seymour, Connecticut 06483, USA



info@thule.com  
customer.service@thule.com

www.thule.com



 [www.thuleprofessional.com](http://www.thuleprofessional.com)

 [info@thule.com](mailto:info@thule.com)  
[customer.service@thule.com](mailto:customer.service@thule.com)

 **NA** Thule Inc., 42 Silvermine Road, Seymour, Connecticut 06483, USA  
 **SW** Thule Sweden AB, Box 69, 330 33 Hillerstorp, SWEDEN

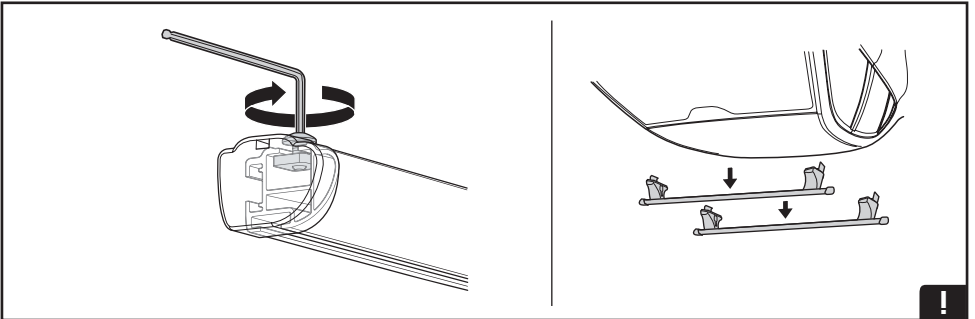
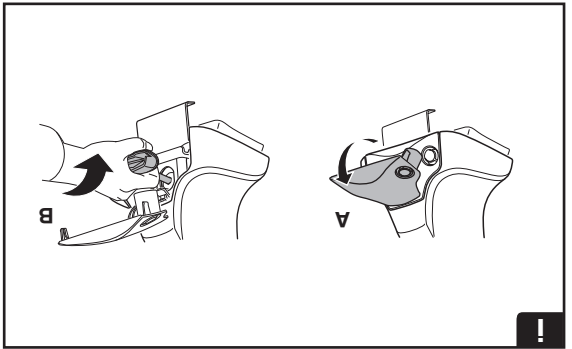
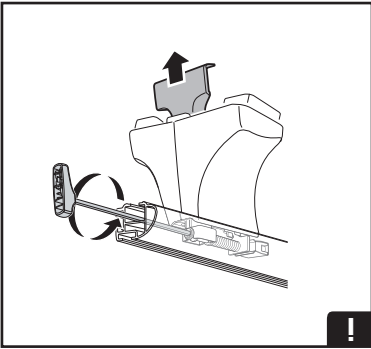
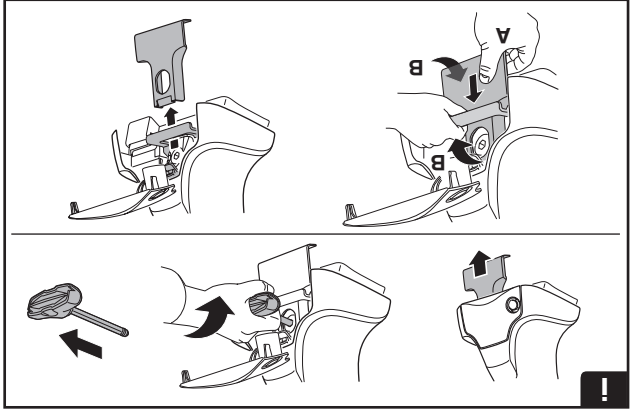
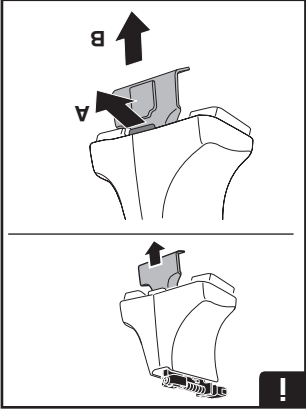

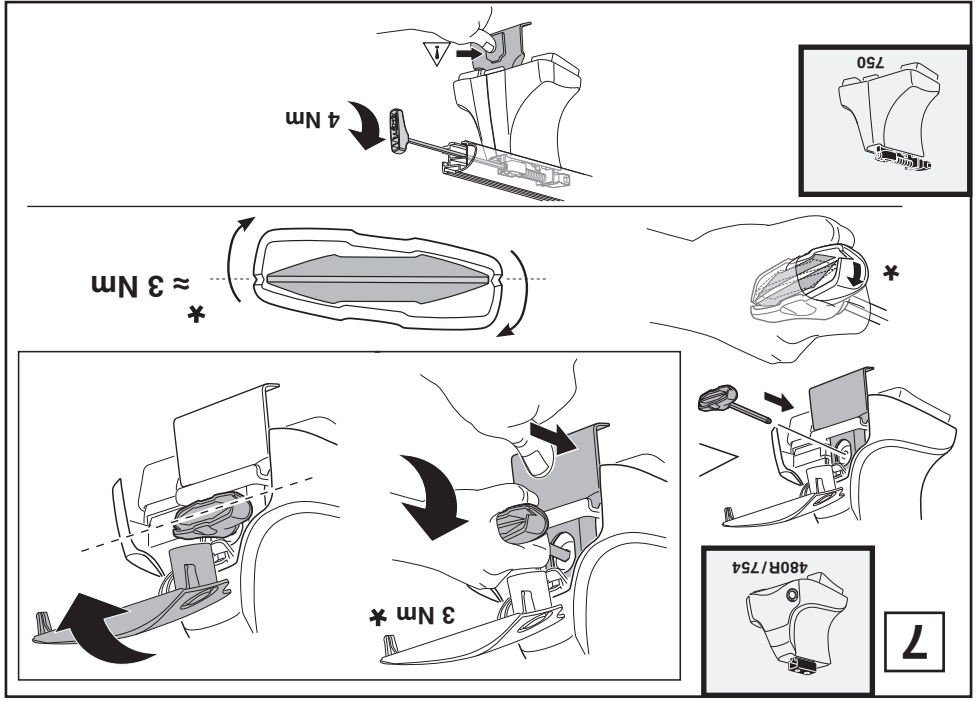
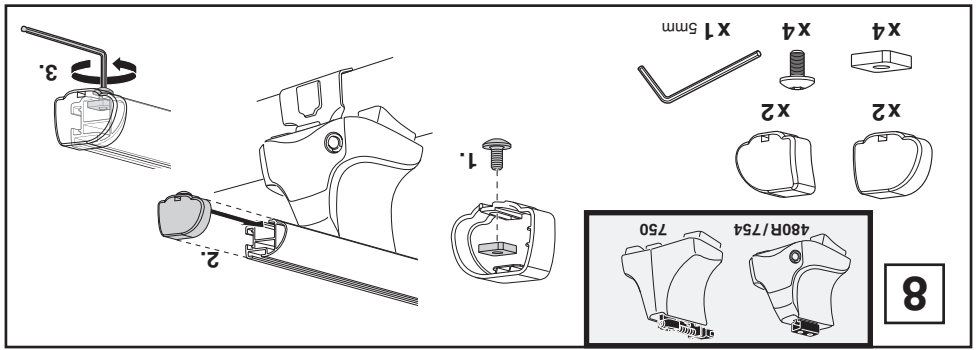
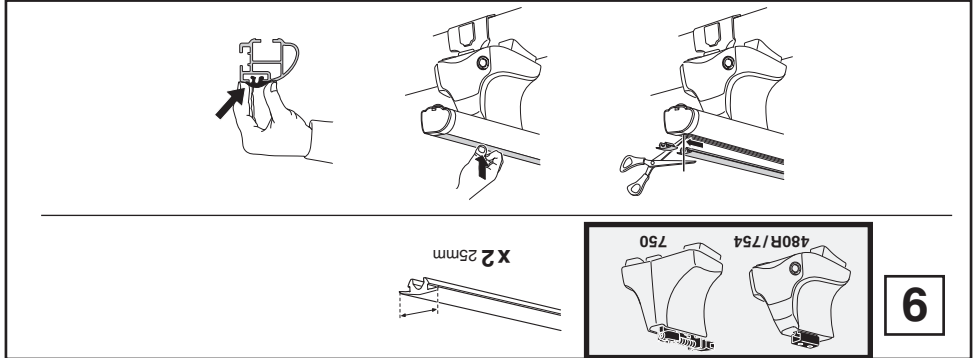

- S Dra åt växelvis
- PT Aperte alternativamente
- E Serrare alternativamente
- I Alternare il serraggio delle viti
- NL de rechterkant aandraken
- F Serrer alternativement chaque côté
- D Die Schrauben abwechselnd
- GB/US Tighen alternatively

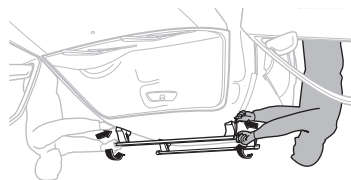

- FIN Kierää vuorotellen
- EST Pinguldage vaheldumisi
- LAT Pivēciēt pamīšus
- LIT Užsukinkite pakaitomis
- PL Śruby dokręcaj naprzemiennie
- RU Затягивайте попеременно
- CZ Pokrétá bagazníka dokręcaj
- SK Dotiahúťe striedavo dokręcaj naprzemiennie.
- SLO Privijajte izmenično.
- HR Naizmjerno zategnite
- HU Egyrésztől fűggetlenül szorítandó
- GR Αφίπυετe εναλλάξ
- TR Dönüşümüü sikin
- 中文 交替拧紧
- 한국어 번갈아 가며 조이십시오.
- 日本語 交互に締め付けください。
- Українська

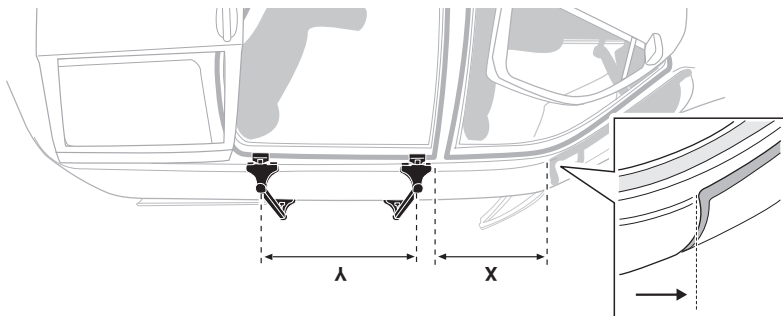
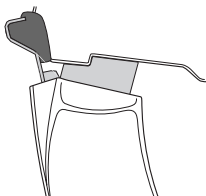

HYUNDAI H-1, 5-dr Van, 08-	850 mm	700 mm	33 1/2"	27 1/2"
HYUNDAI Load, 5-dr Van, 08-	850 mm	700 mm	33 1/2"	27 1/2"
HYUNDAI Max, 5-dr Bus, 08-	850 mm	700 mm	33 1/2"	27 1/2"
HYUNDAI Starax, 5-dr Van, 08-	850 mm	700 mm	33 1/2"	27 1/2"

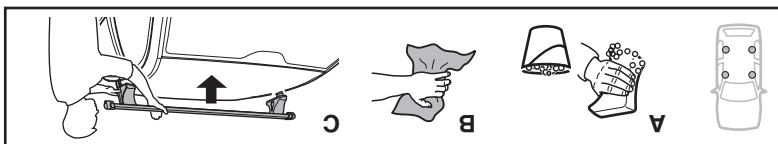

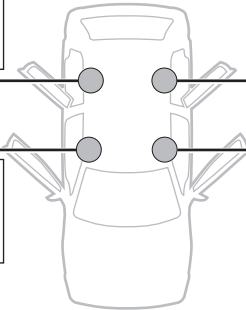
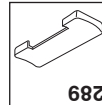
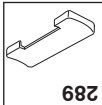
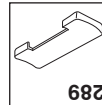
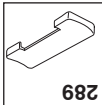
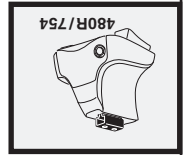
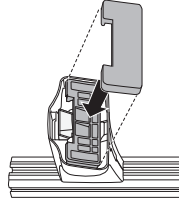
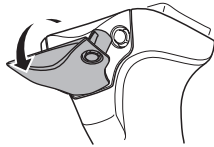
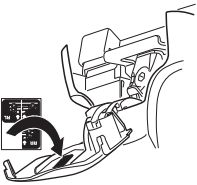
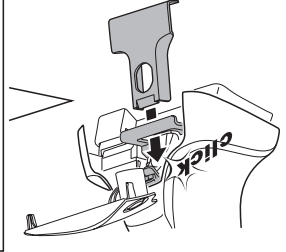
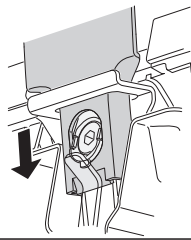
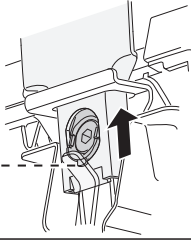
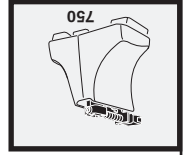
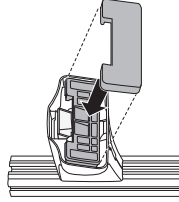
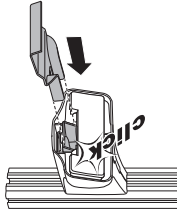
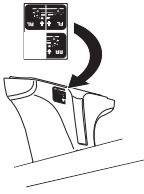

HYUNDAI H-1, 5-dr Van, 08-  
HYUNDAI iLoad, 5-dr Van, 08-  
HYUNDAI iMax, 5-dr Bus, 08-  
HYUNDAI Starex, 5-dr Van, 08-

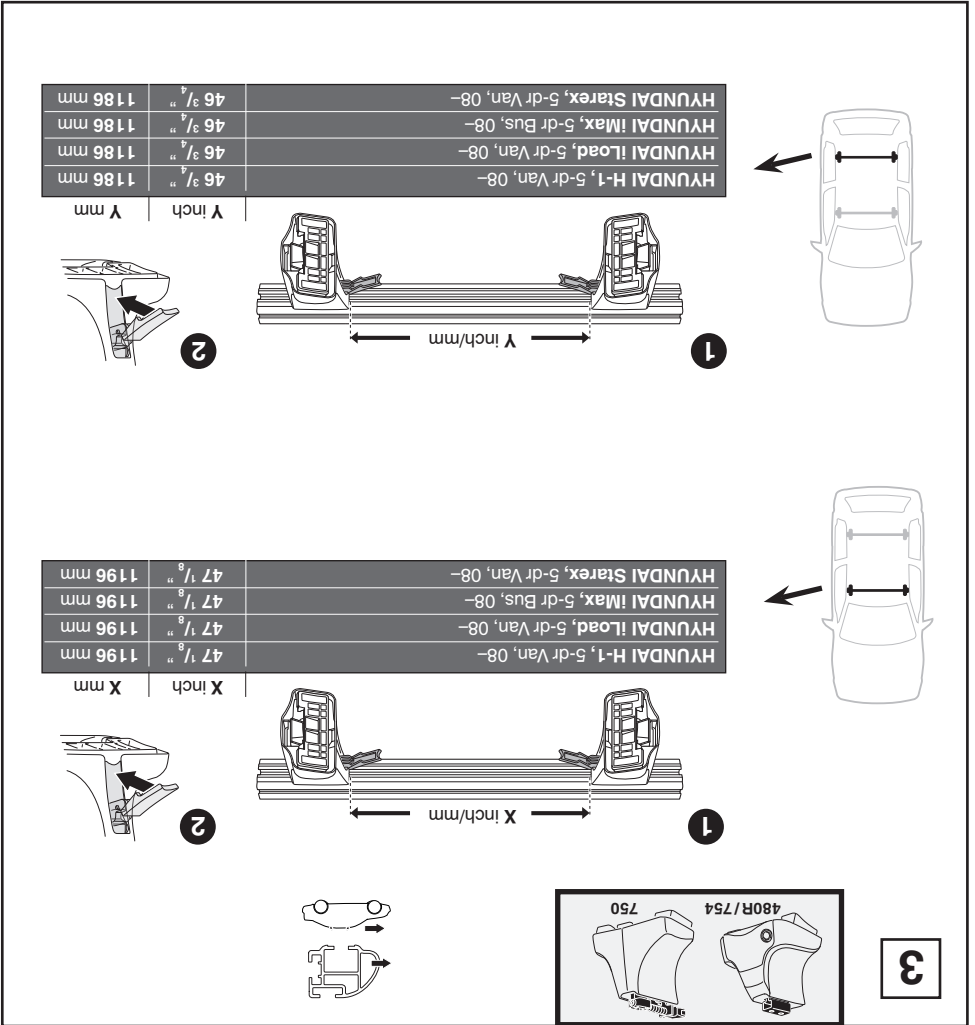
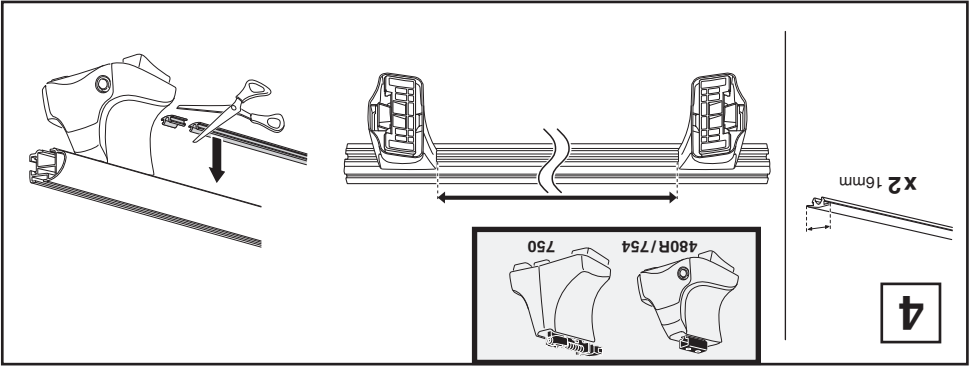

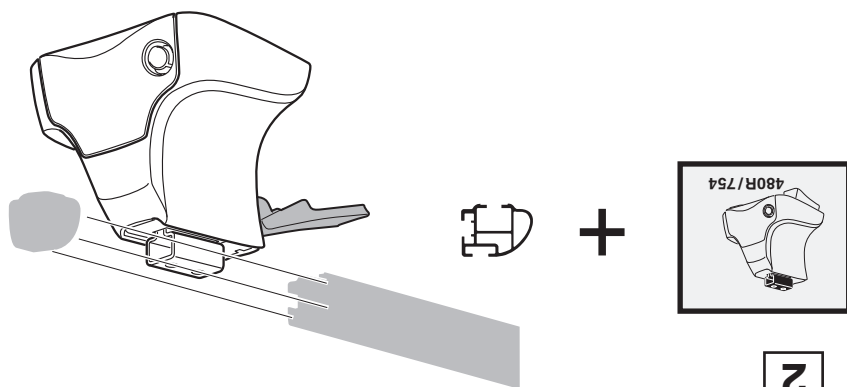
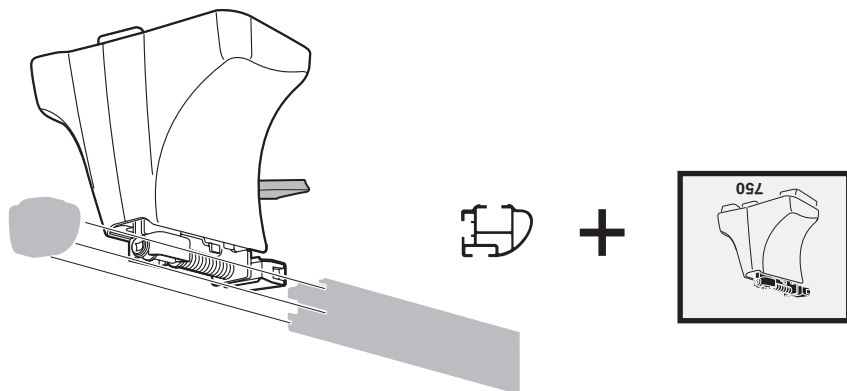

2

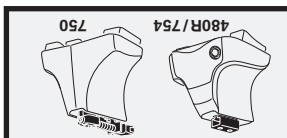
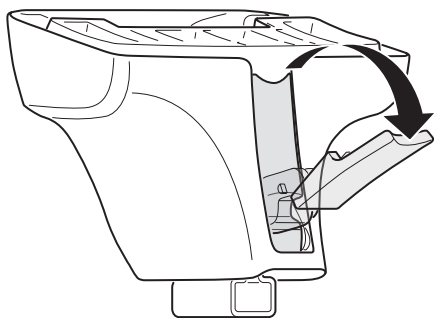

1

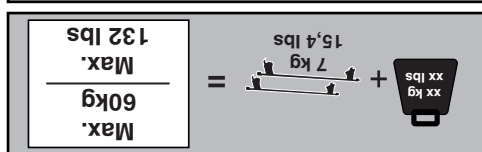
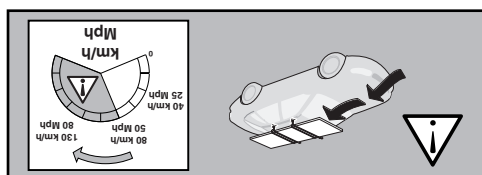
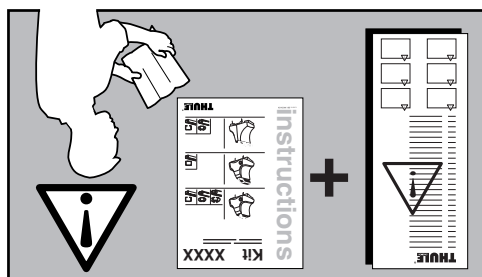
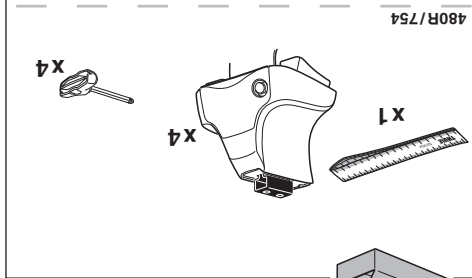
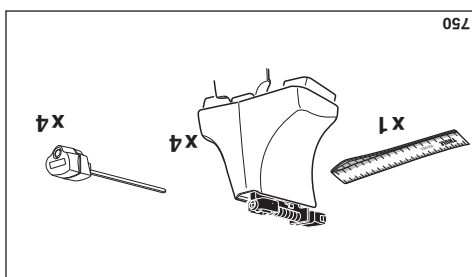
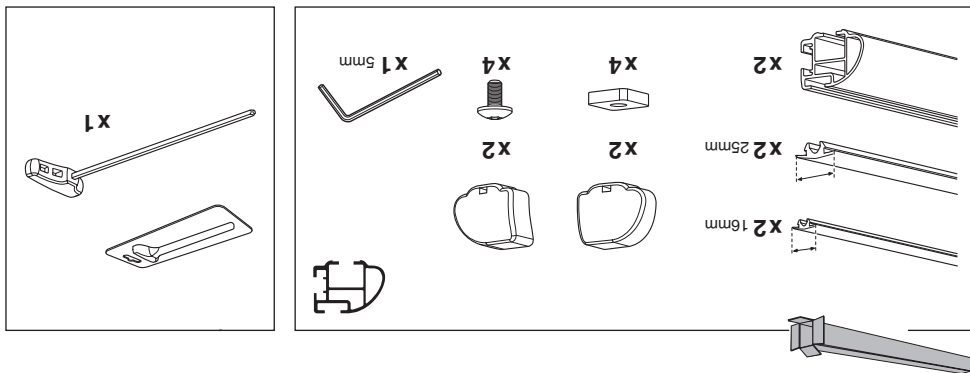
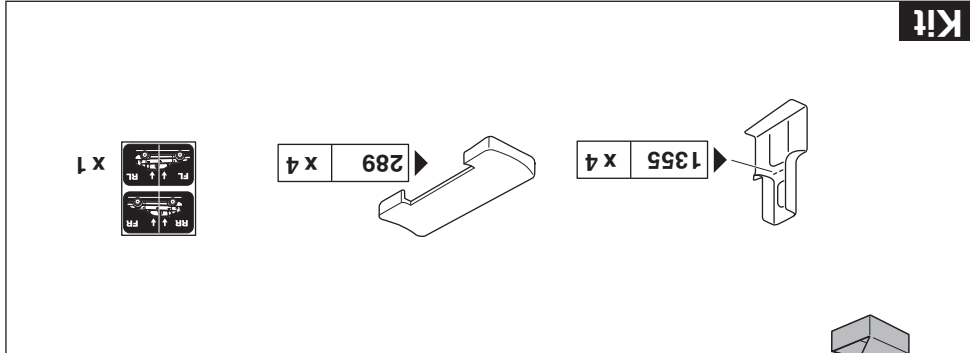

# instructions

# Kit 1475

- HYUNDAI H-1, 5-dr Van, 08-\*
- HYUNDAI iLoad, 5-dr Van, 08-\*\*
- HYUNDAI iMax, 5-dr Bus, 08-\*\*
- HYUNDAI Starex, 5-dr Van, 08-\*

\* with dual sliding doors  
 \*\* with dual sliding doors (Asia)

480R  
754

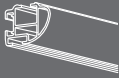
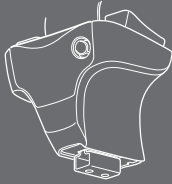

750

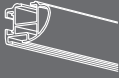
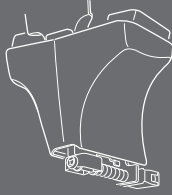

**THULE**  
SWEDEN

PROFESSIONAL

ISO 11154-E