

Kit 1009

MERCEDES BENZ 190 (W201), 4-dr Sedan, 83-93 / *84-93

MERCEDES BENZ 190 (W201), 5-dr Estate, 83-93

MERCEDES BENZ 190 (W201), 5-dr Wagon, *84-93

MERCEDES BENZ 200-500 (W124), 4-dr Sedan, 85-95

MERCEDES BENZ 200-500 (W124), 5-dr Estate, 85-95

MERCEDES BENZ C-Class (W202), 4-dr Sedan, 93-99 / *94-00

MERCEDES BENZ C-Class (W202), 5-dr Estate, 93-99

MERCEDES BENZ E-Class (W210), 4-dr, Sedan 95-01 / *96-02

*North America

480R
754

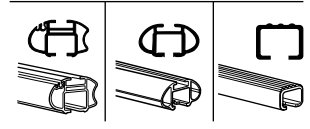
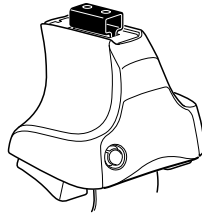

480

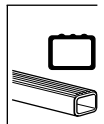
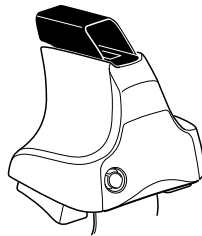

750

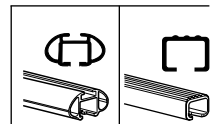
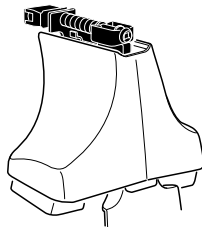

THULE[®]
SWEDEN

ISO 11154-E

Kit

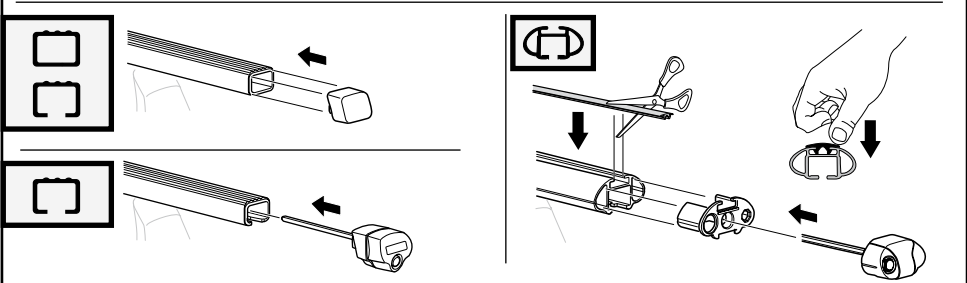
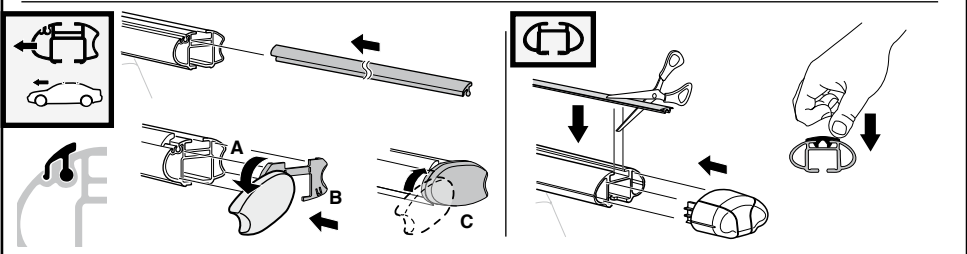
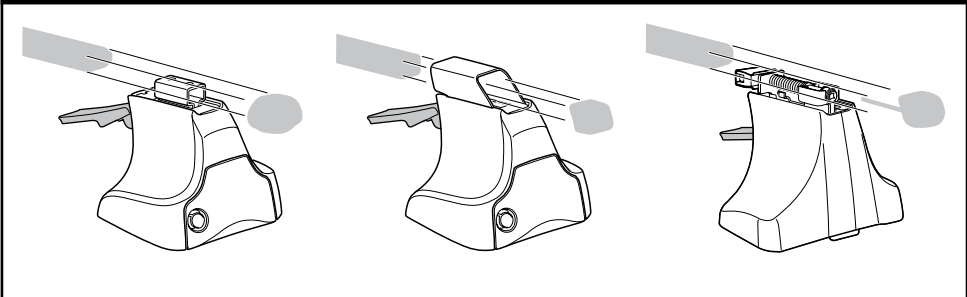
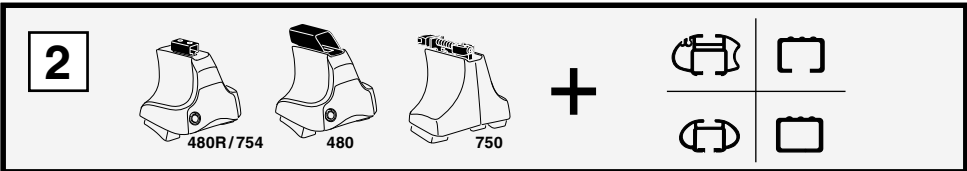
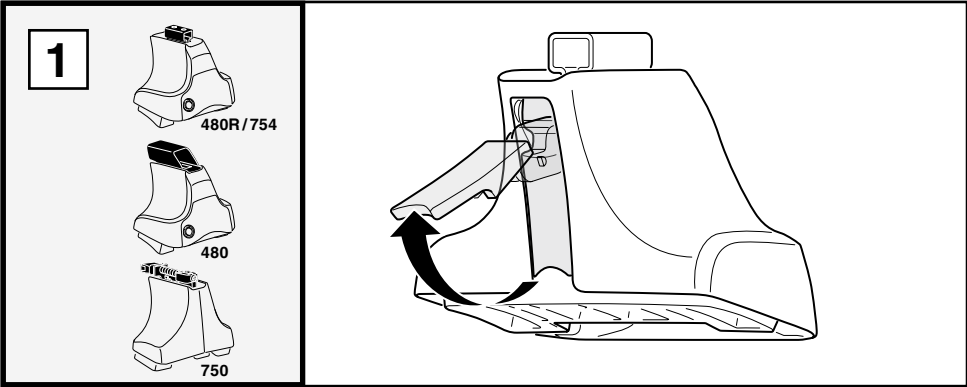

3

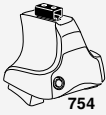

754

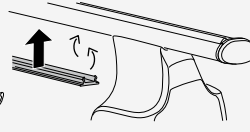
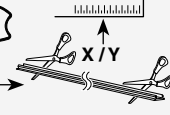

750



1

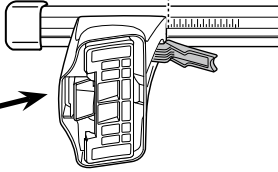
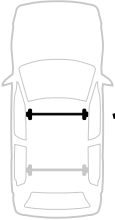

2

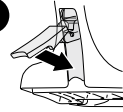

	X
MERCEDES BENZ 190 (W201), 4-dr Sedan, 83-93 / *84-93	33
MERCEDES BENZ 190 (W201), 5-dr Estate, 83-93	33
MERCEDES BENZ 190 (W201), 5-dr Wagon, *84-93	33
MERCEDES BENZ 200-500 (W124), 4-dr Sedan, 85-95	38
MERCEDES BENZ 200-500 (W124), 5-dr Estate, 85-95	38
MERCEDES BENZ C-Class (W202), 4-dr Sedan, 93-99 / *94-00	35,5
MERCEDES BENZ C-Class (W202), 5-dr Estate, 93-99	35,5
MERCEDES BENZ E-Class (W210), 4-dr, Sedan 95-01 / *96-02	38

1

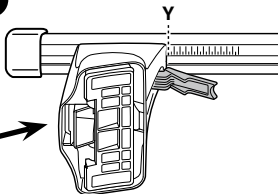

2

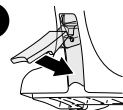

	Y
MERCEDES BENZ 190 (W201), 4-dr Sedan, 83-93 / *84-93	31,5
MERCEDES BENZ 190 (W201), 5-dr Estate, 83-93	31,5
MERCEDES BENZ 190 (W201), 5-dr Wagon, *84-93	31,5
MERCEDES BENZ 200-500 (W124), 4-dr Sedan, 85-95	36,5
MERCEDES BENZ 200-500 (W124), 5-dr Estate, 85-95	36,5
MERCEDES BENZ C-Class (W202), 4-dr Sedan, 93-99 / *94-00	33
MERCEDES BENZ C-Class (W202), 5-dr Estate, 93-99	33
MERCEDES BENZ E-Class (W210), 4-dr, Sedan 95-01 / *96-02	38

3



480R



480

1

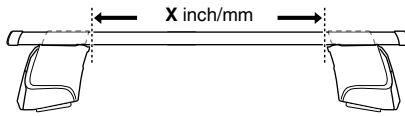

2

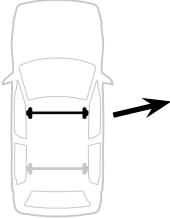
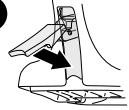

	X inch	X mm
MERCEDES BENZ 190 (W201), 4-dr Sedan, 83-93 / *84-93	38 ⁵ / ₈ "	981 mm
MERCEDES BENZ 190 (W201), 5-dr Estate, 83-93	38 ⁵ / ₈ "	981 mm
MERCEDES BENZ 190 (W201), 5-dr Wagon, *84-93	38 ⁵ / ₈ "	981 mm
MERCEDES BENZ 200-500 (W124), 4-dr Sedan, 85-95	40 ⁵ / ₈ "	1031 mm
MERCEDES BENZ 200-500 (W124), 5-dr Estate, 85-95	40 ⁵ / ₈ "	1031 mm
MERCEDES BENZ C-Class (W202), 4-dr Sedan, 93-99 / *94-00	39 ⁵ / ₈ "	1006 mm
MERCEDES BENZ C-Class (W202), 5-dr Estate, 93-99	39 ⁵ / ₈ "	1006 mm
MERCEDES BENZ E-Class (W210), 4-dr, Sedan 95-01 / *96-02	40 ⁵ / ₈ "	1031 mm

1

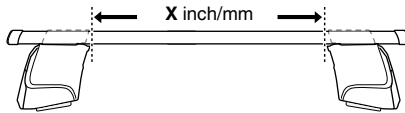

2

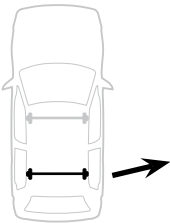
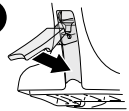

	X inch	X mm
MERCEDES BENZ 190 (W201), 4-dr Sedan, 83-93 / *84-93	38 "	966 mm
MERCEDES BENZ 190 (W201), 5-dr Estate, 83-93	38 "	966 mm
MERCEDES BENZ 190 (W201), 5-dr Wagon, *84-93	38 "	966 mm
MERCEDES BENZ 200-500 (W124), 4-dr Sedan, 85-95	40 "	1016 mm
MERCEDES BENZ 200-500 (W124), 5-dr Estate, 85-95	40 "	1016 mm
MERCEDES BENZ C-Class (W202), 4-dr Sedan, 93-99 / *94-00	38 ⁵ / ₈ "	981 mm
MERCEDES BENZ C-Class (W202), 5-dr Estate, 93-99	38 ⁵ / ₈ "	981 mm
MERCEDES BENZ E-Class (W210), 4-dr, Sedan 95-01 / *96-02	40 ⁵ / ₈ "	1031 mm

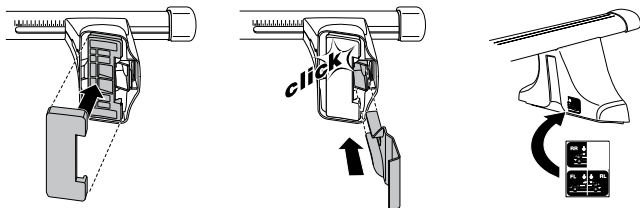
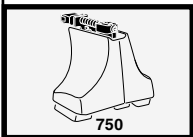
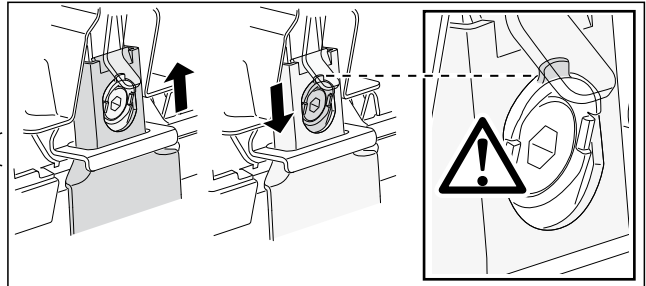
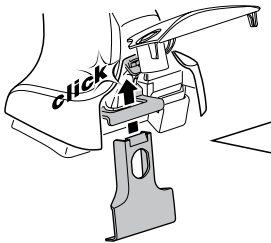
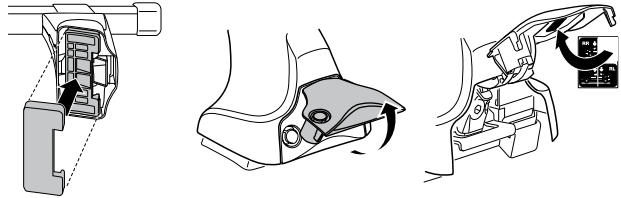
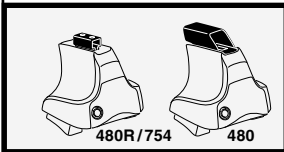
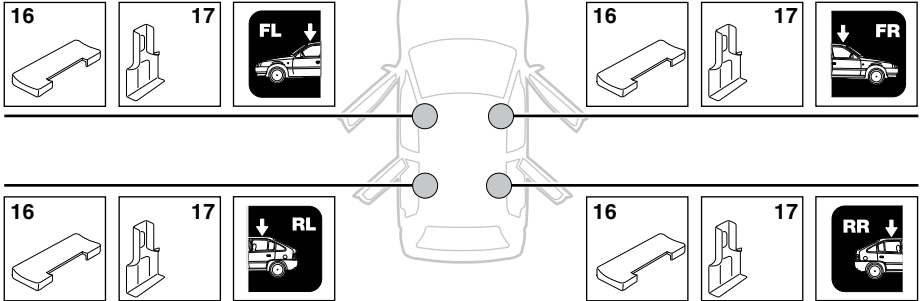
4**MERCEDES BENZ 190 (W201), 4-dr Sedan, 83-93 / *84-93****MERCEDES BENZ 190 (W201), 5-dr Estate, 83-93****MERCEDES BENZ 190 (W201), 5-dr Wagon, *84-93****MERCEDES BENZ 200-500 (W124), 4-dr Sedan, 85-95****MERCEDES BENZ 200-500 (W124), 5-dr Estate, 85-95**

4

MERCEDES BENZ C-Class (W202), 4-dr Sedan, 93-99 / *94-00

MERCEDES BENZ C-Class (W202), 5-dr Estate, 93-99

MERCEDES BENZ E-Class (W210), 4-dr, Sedan 95-01 / *96-02

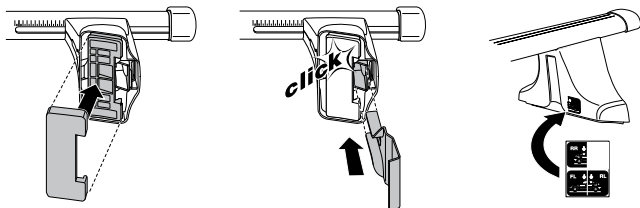
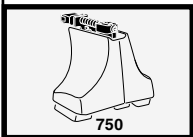
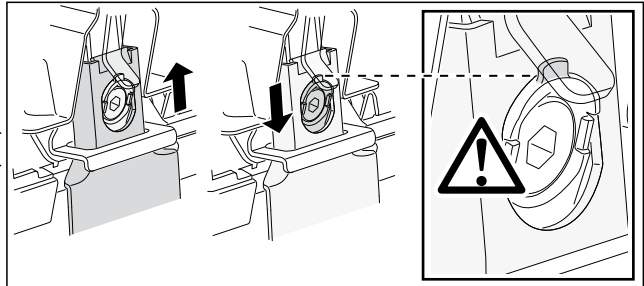
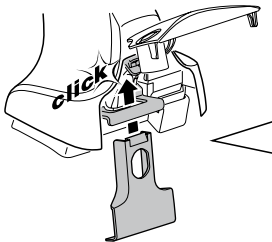
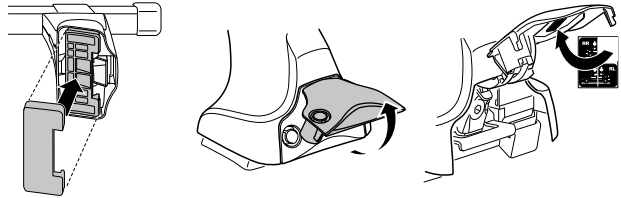
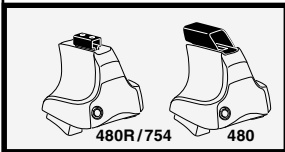
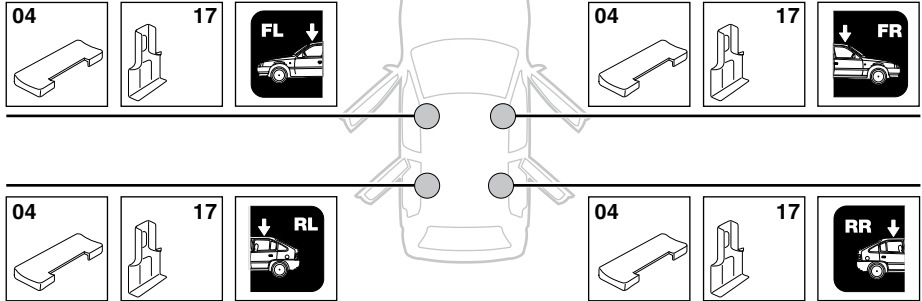

5

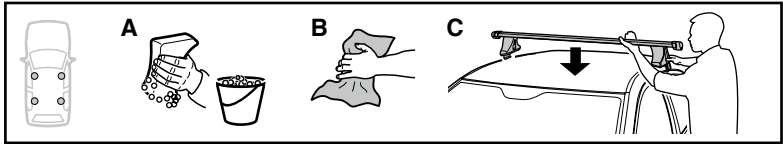

- MERCEDES BENZ 190 (W201), 4-dr Sedan, 83-93 / *84-93
- MERCEDES BENZ 190 (W201), 5-dr Estate, 83-93
- MERCEDES BENZ 190 (W201), 5-dr Wagon, *84-93
- MERCEDES BENZ 200-500 (W124), 4-dr Sedan, 85-95
- MERCEDES BENZ 200-500 (W124), 5-dr Estate, 85-95
- MERCEDES BENZ C-Class (W202), 4-dr Sedan, 93-99 / *94-00
- MERCEDES BENZ C-Class (W202), 5-dr Estate, 93-99

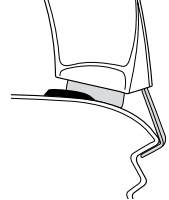
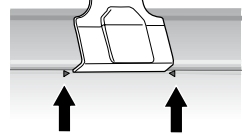
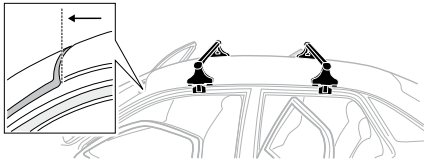

	X mm	Y mm	X inch	Y inch
MERCEDES BENZ E-Class (W210), 4-dr, Sedan 95-01 / *96-02	210 mm	700 mm	8 1/4"	27 1/2"

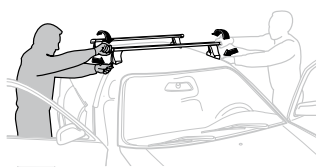
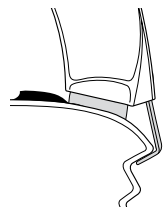
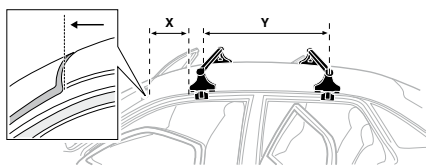

- GB/US Tighten alternately
- D Die Schrauben abwechselnd anziehen
- F Serrer alternativement chaque côté
- NL Afwisselend aan de linker- en de rechterkant aandraaien
- I Alternare il serraggio delle viti
- E Apretar alternativamente
- PT Aperte alternadamente
- S Dra åt växelvis
- FIN Kiertää vuorotellen
- EST Pinguldage vaheldumisi
- LAT Pieļieciet pamīšus
- LIT Užsukinėkite pakaitomis
- PL Śruby dokręcaj naprzemiennie
- RU Затягивайте попеременно

- CZ Pokręťta багаžníka dokręcaj dokręcaj naprzemiennie.
- SK Dofahujte striedavo
- SLO Privijajte izmenično.
- HR Naizmjenično zategnite
- HU Egy mástól függetlenül szorítandó
- GR Σφιγγείτε εναλλάξ
- TR Dönüşümlü sıkın
- 中文 交替拧紧
- 한국어 번갈아 가며 조이십시오.
- 日本語 交互に締め付けてください。
- ไทย ขั้วในแบบสลับ

6

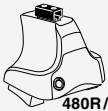

480R/754



480

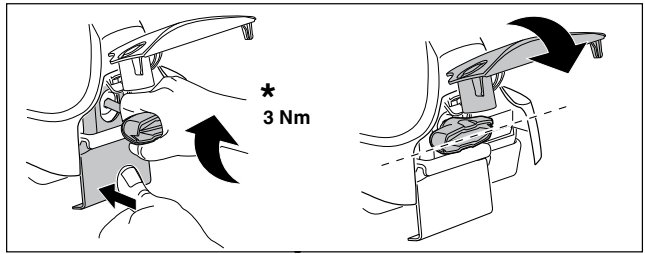
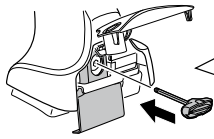

*
3 Nm

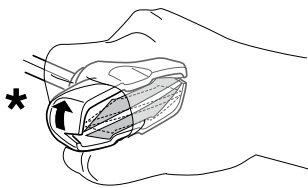

*

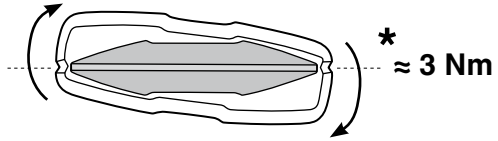

*
≈ 3 Nm

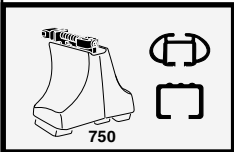
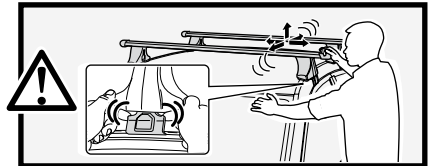

750

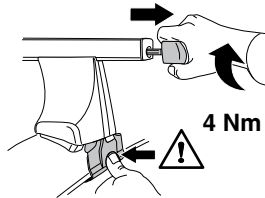

4 Nm

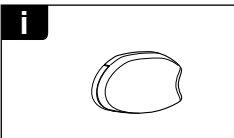
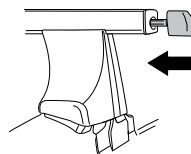

i

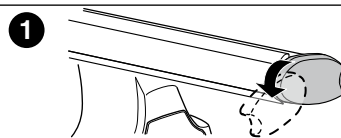

1

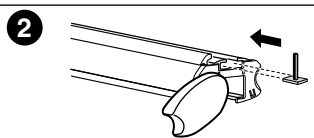

2

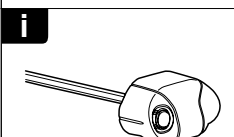

i

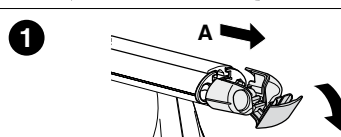

1

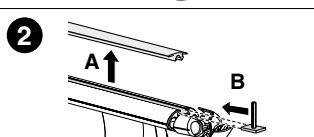

2

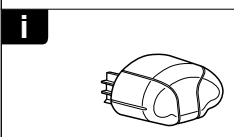

i

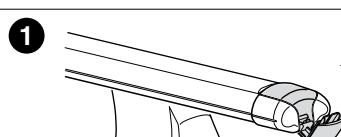

1

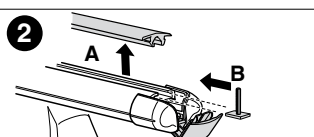

2

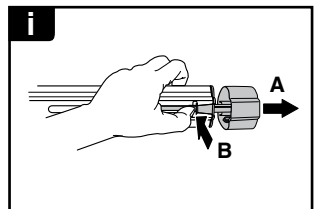
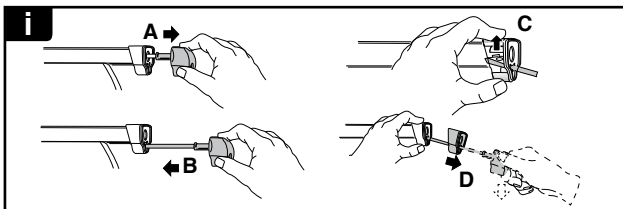
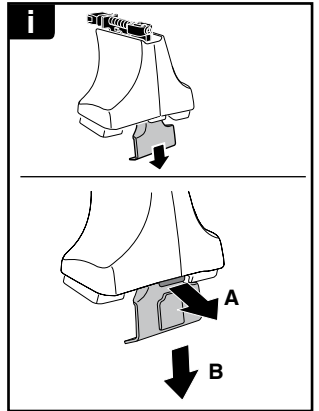
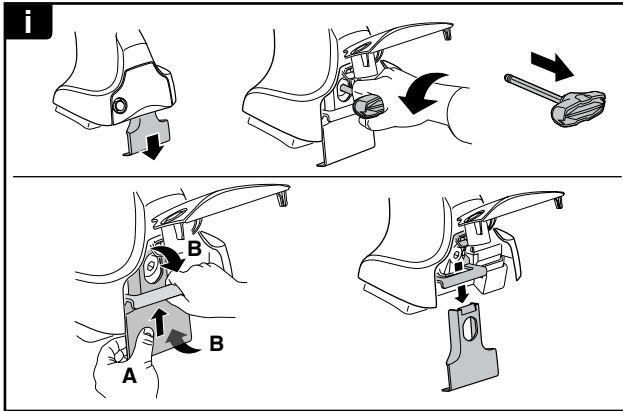
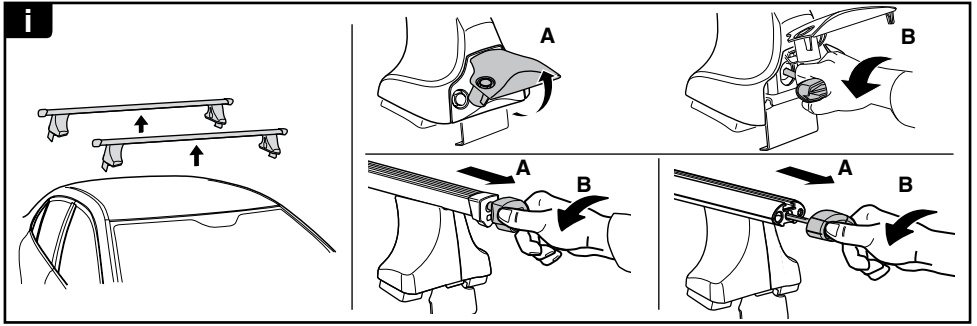

THULE
SWEDEN
**ONE
KEY
SYSTEM**

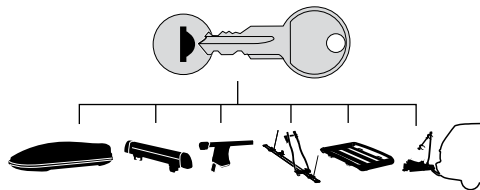

		(x4)
		(x6)
		(x8)
NA		(x10)
EUR		(x12)
ASIA		

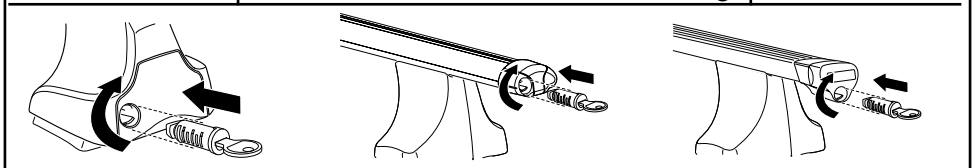

WW ▶ Thule Sweden AB, Box 69, 330 33 Hillerstorp, SWEDEN
NA ▶ Thule Inc., 42 Silvermine Road, Seymour, Connecticut 06483, USA

info@thule.com
customer.service@thule.com

www.thule.com

503-1009-03