

# Kit 1676

HYUNDAI Veloster, 3-dr Hatchback, 11-

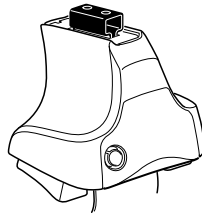

754 Rapid System  
480R Rapid Traverse (North America)

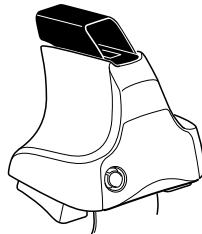
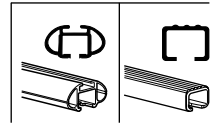

480 Traverse (North America)

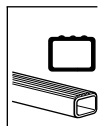



1

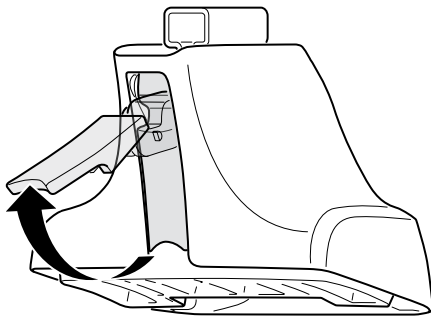

2



754 Rapid System  
480R Rapid Traverse  
(North America)

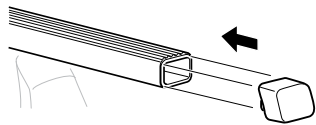
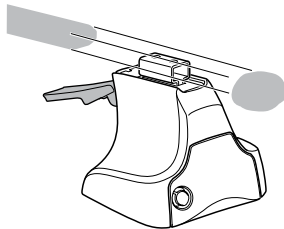

x4

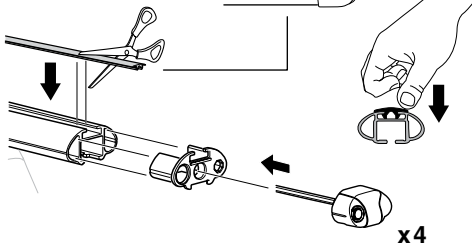
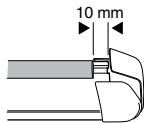
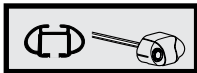

x4

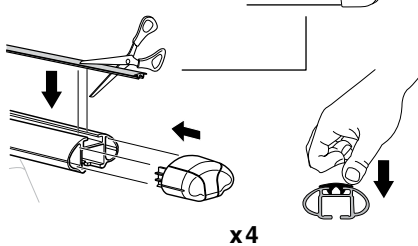
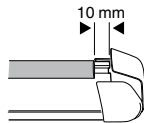
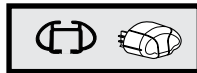

x4



480 Traverse  
(North America)

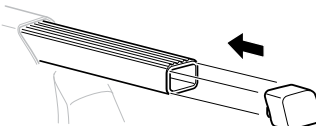
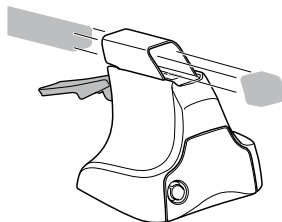

x4

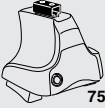
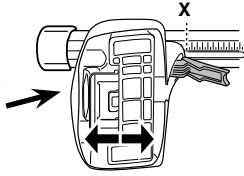
**3****754** Rapid System

	<b>X</b>
<b>HYUNDAI Veloster, 3-dr Hatchback, 11-</b>	<b>41</b>

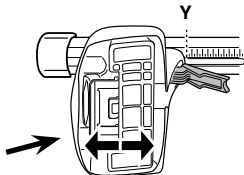

	<b>Y</b>
<b>HYUNDAI Veloster, 3-dr Hatchback, 11-</b>	<b>43,5</b>

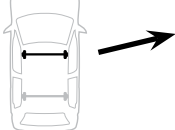
**3****480R** Rapid Traverse**480** Traverse**(North America)**

	<b>X inch</b>	<b>X mm</b>
<b>HYUNDAI Veloster, 3-dr Hatchback, 11-</b>	<b>41 3/4"</b>	<b>1061 mm</b>

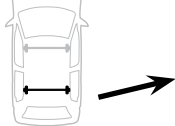

	<b>Y inch</b>	<b>Y mm</b>
<b>HYUNDAI Veloster, 3-dr Hatchback, 11-</b>	<b>42 3/4"</b>	<b>1086 mm</b>

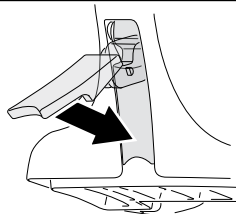
**4**

# 5

HYUNDAI Veloster, 3-dr Hatchback, 11-

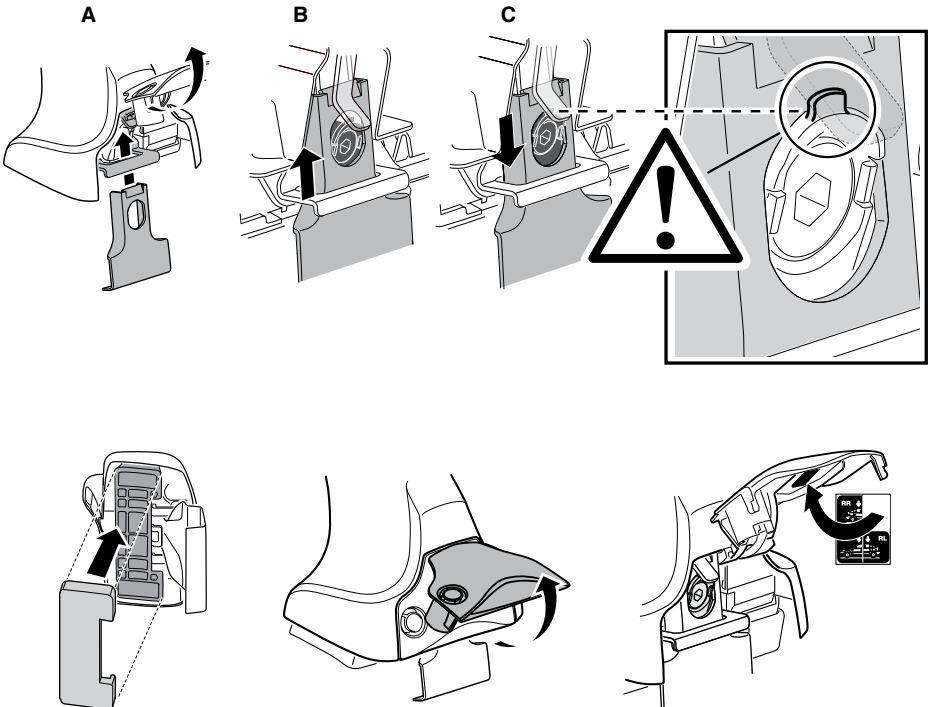
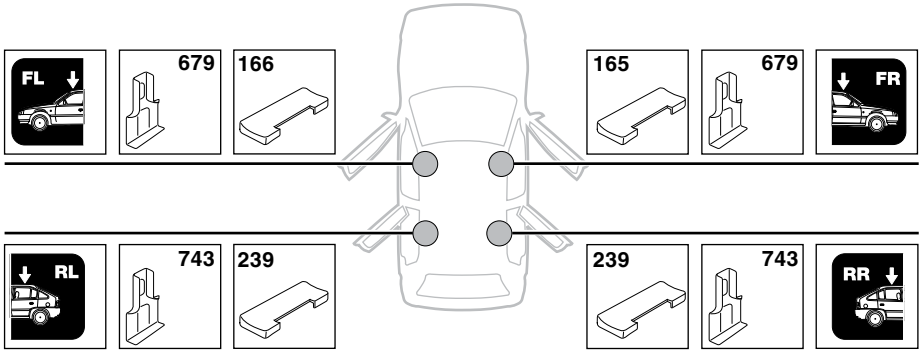

6

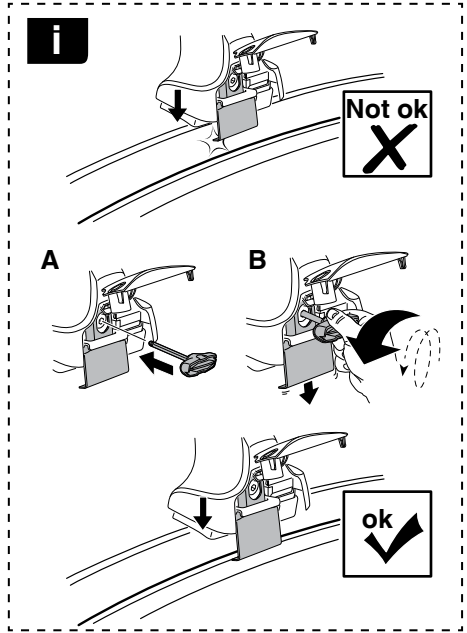

HYUNDAI Veloster, 3-dr Hatchback, 11-

X mm	Y mm	X inch	Y inch
130 mm	600 mm	5 1/8"	23 5/8"

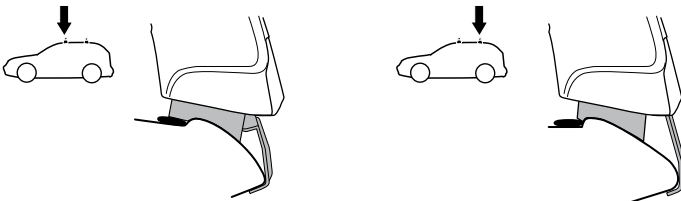
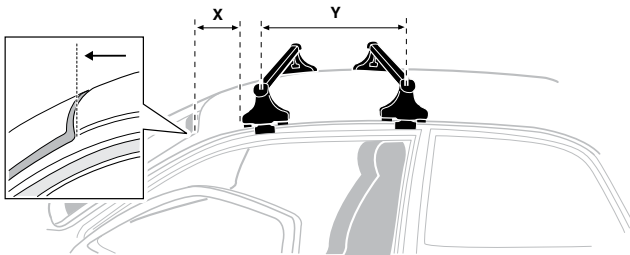

7

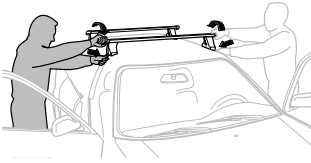

<b>GB/US</b>	Tighten alternately
<b>D</b>	Die Schrauben abwechselnd anziehen
<b>F</b>	Serrer alternativement chaque côté
<b>NL</b>	Afwisselend aan de linker- en de rechterkant aandraaien
<b>I</b>	Alternare il serraggio delle viti
<b>E</b>	Apertar alternativamente
<b>PT</b>	Aperte alternadamente
<b>S</b>	Dra åt växelvis
<b>FIN</b>	Kierrä vuorotellen
<b>EST</b>	Pinguldage vaheldumisi
<b>LAT</b>	Pielveiciet pamišus
<b>LIT</b>	Užsukinėkite pakaitomis
<b>PL</b>	Śruby dokręcaj naprzemiennie
<b>RU</b>	Загряивайте попеременно

<b>CZ</b>	Pokręřta bagažníka dokręřcaj dokręřcaj naprzemiennie.
<b>SK</b>	Dofahajte striedavo
<b>SLO</b>	Privijajte izmenično.
<b>HR</b>	Naizmjenočno zategnite
<b>HU</b>	Egymástól függetlenül szorítandó
<b>GR</b>	Σφιγίγτες εναλλάξ
<b>TR</b>	Dönüşümlü sıkın

**中文** 交替拧紧

**한국어** 번갈아 가며 조이십시오.

**日本語** 交互に締め付けてください。

**ไทย** ชันในแบบสลับ

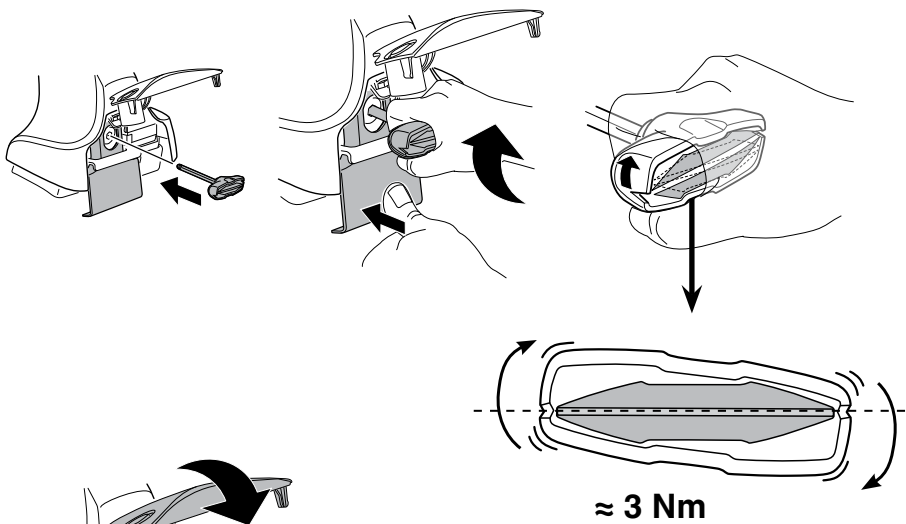

8



x1  
17 mm

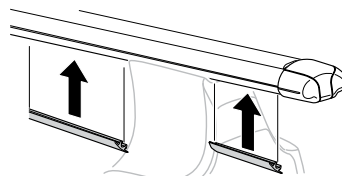
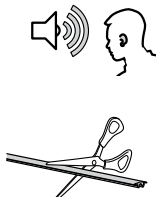

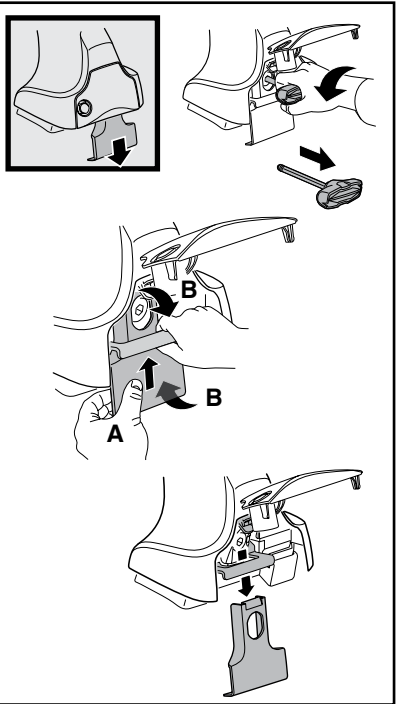
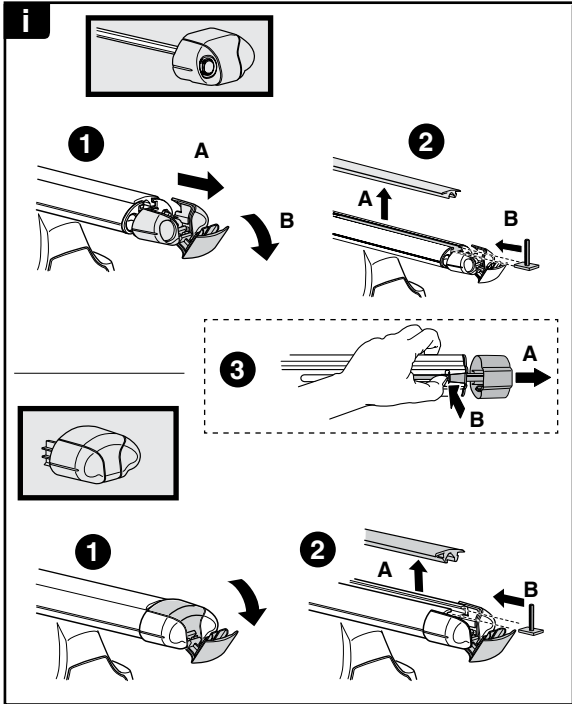

**THULE**  
SWEDEN  
**ONE  
KEY  
SYSTEM**

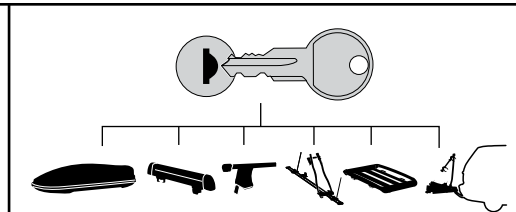

		(x4)
		(x6)
		(x8)
NA		(x10)
EUR		(x12)
ASIA		

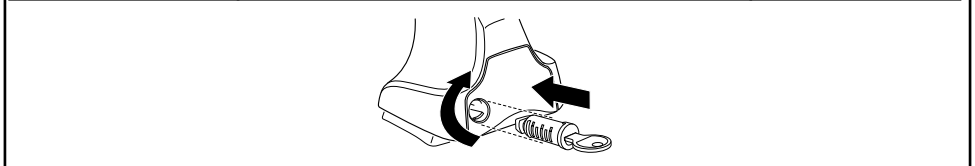

WW ▶ Thule Sweden AB, Box 69, 330 33 Hillerstorp, SWEDEN  
NA ▶ Thule Inc., 42 Silvermine Road, Seymour, Connecticut 06483, USA

info@thule.com  
customer.service@thule.com

www.thule.com