

# Kit 1446

TOYOTA Corolla, 4-dr Sedan, 07-

480R  
754

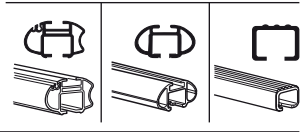
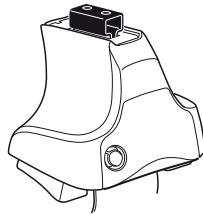

480

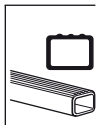
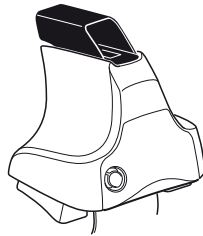

750

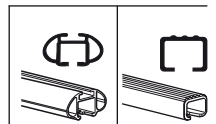
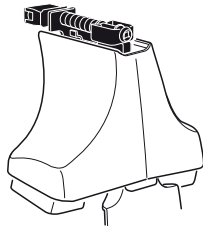

**Kit**



3



754

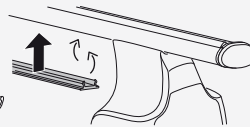
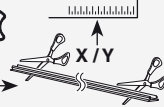

750



1

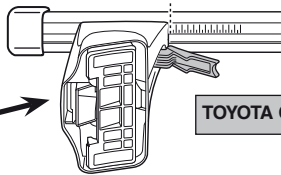
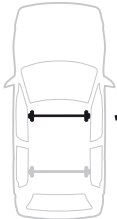

2

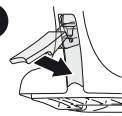

TOYOTA Corolla, 4-dr Sedan, 07-

X
34,5

1

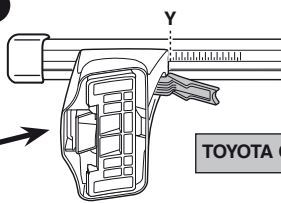
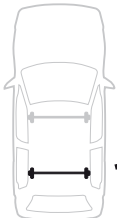

2

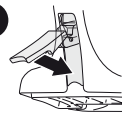

TOYOTA Corolla, 4-dr Sedan, 07-

Y
32



480R



480

1

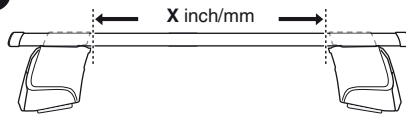

2



TOYOTA Corolla, 4-dr Sedan, 07-

X inch	X mm
39 1/4"	996 mm

1

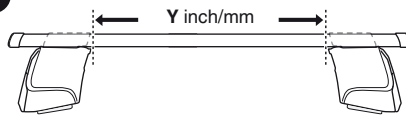

2

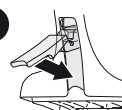

TOYOTA Corolla, 4-dr Sedan, 07-

Y inch	Y mm
38 1/4"	971 mm

4

TOYOTA Corolla, 4-dr Sedan, 07-

312



1017



311



1017



314



1018



313



1018

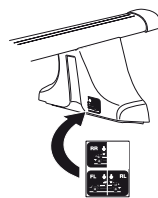
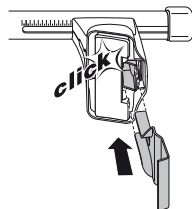
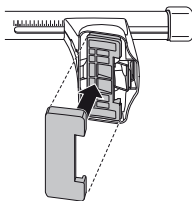
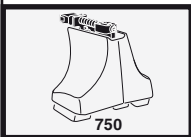
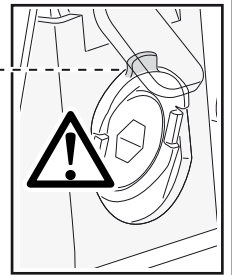
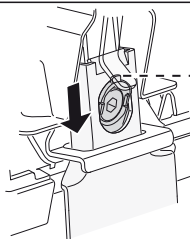
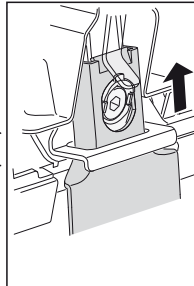
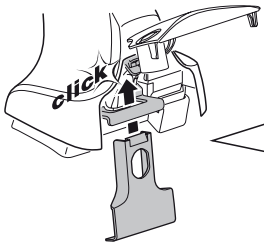
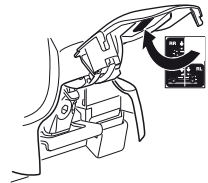
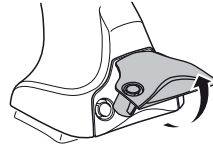
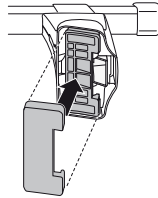
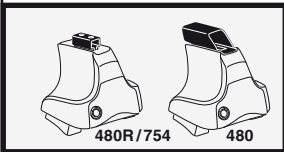

5



	X mm	Y mm	X inch	Y inch
TOYOTA Corolla, 4-dr Sedan, 07-	215 mm	715 mm	8 1/2"	28 1/8"

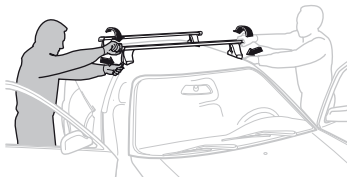
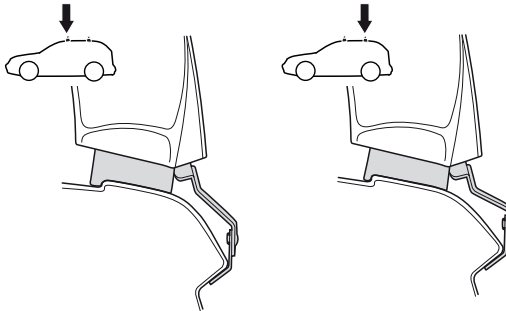
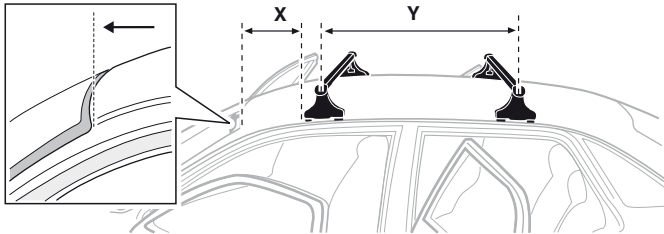

**GB/US** Tighten alternately

**D** Die Schrauben abwechselnd anziehen

**F** Serrer alternativement chaque côté

**NL** Afwisselend aan de linker- en de rechterkant aandraaien

**I** Alternare il serraggio delle viti

**E** Apretar alternativamente

**PT** Aperte alternadamente

**S** Dra åt växelvis

**FIN** Kierrä vuorotellen

**EST** Pinguldage vaheldumisi

**LAT** Pielieciet pamišus

**LIT** Užsukinėkite pakaitomis

**PL** Śruby dokręcaj naprzemiennie

**RU** Затягивайте попеременно

**CZ** Pokręťta bagažníka dokręcaj dokręcaj naprzemiennie.

**SK** Doťahujte striedavo

**SLO** Privijajte izmenično.

**HR** Naizmjenično zategnite

**HU** Egymástól függetlenül szorítandó

**GR** Σφιγγετε εναλλάξ

**TR** Dönüşümlü sıkın

**中文** 交替拧紧

**한국어** 번갈아 가며 조이십시오.

**日本語** 交互に締め付けてください。

**ไทย** ชันโนแบบสลับ

6



480R/754





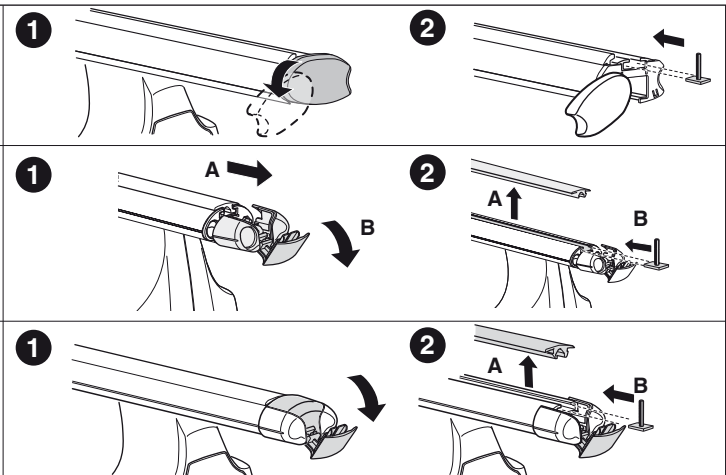
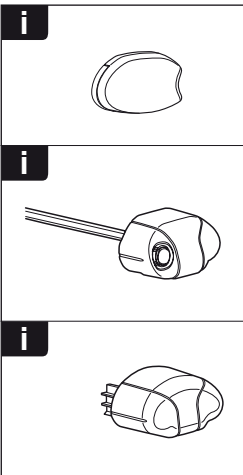
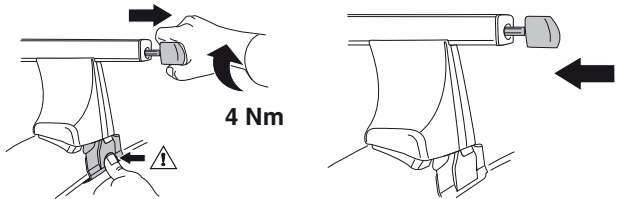
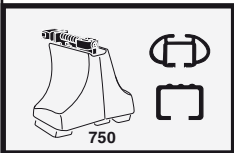
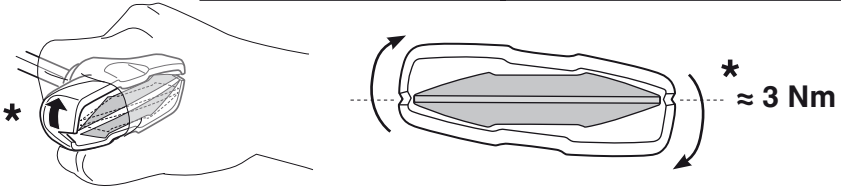
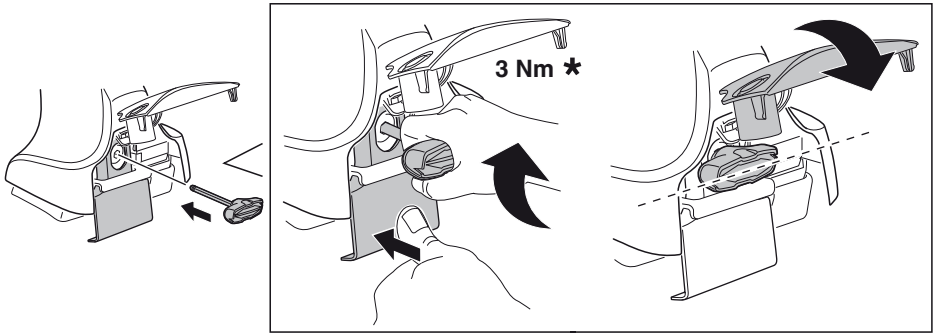

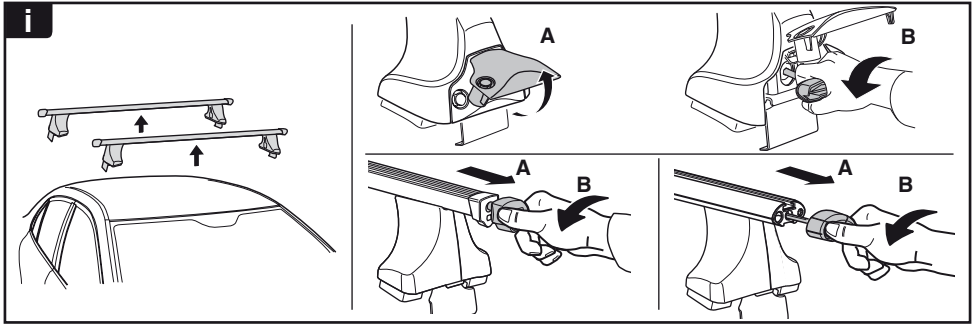

480



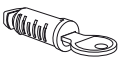

**THULE**  
SWEDEN  
**ONE  
KEY  
SYSTEM**



-  **544** (x4)
-  **596** (x6)
-  **588** (x8)
-  **510** (x10)
-  **EUR**
-  **452** (x12)
-  **ASIA**



**WW** ▶ Thule Sweden AB, Box 69, 330 33 Hillerstorp, SWEDEN  
**NA** ▶ Thule Inc., 42 Silvermine Road, Seymour, Connecticut 06483, USA

 [info@thule.com](mailto:info@thule.com)  
[customer.service@thule.com](mailto:customer.service@thule.com)

 [www.thule.com](http://www.thule.com)