



# Thule Rapid System Kit 1732

# > Instructions

NISSAN Sentra, 4-dr Sedan, \*13-

\*North America

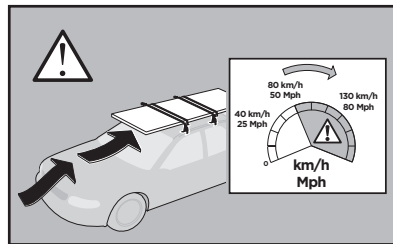
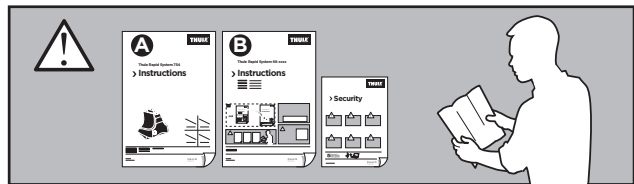
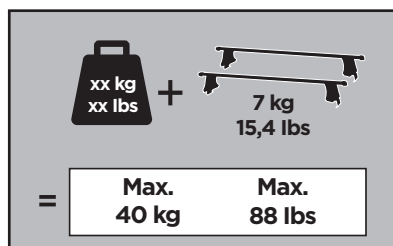

ISO 11154-E

141732  
C.20130701  
519-1732-01

Bring your life  
thule.com



271 x2

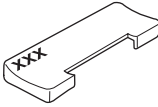

328 x2

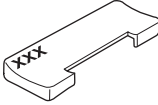

594 x2



1214 x2



x1



x1

# 1

	X (scale)	X (mm)	X (inch)
NISSAN Sentra, 4-dr Sedan, *13-	39,5	1046	41 1/8

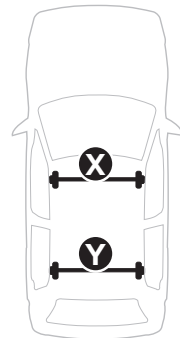
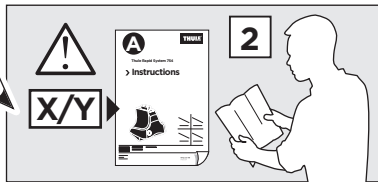
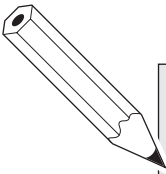

	Y (scale)	Y (mm)	Y (inch)
NISSAN Sentra, 4-dr Sedan, *13-	37,5	1026	40 3/8

**2**

**NISSAN Sentra, 4-dr Sedan, \*13-**

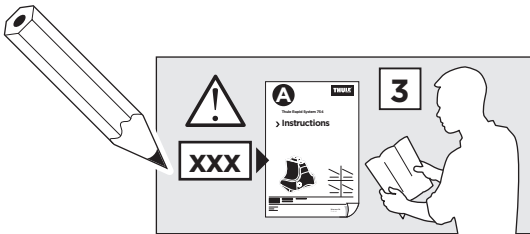
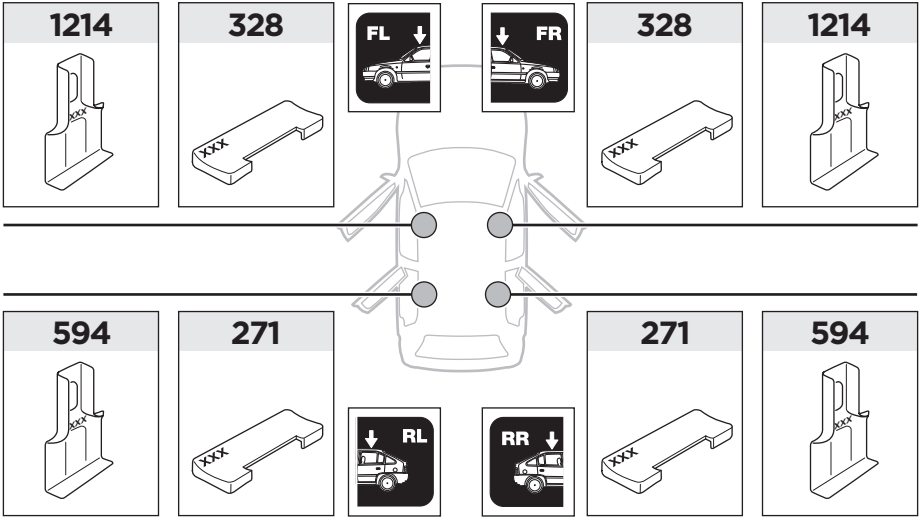

**3**

	W (mm)	Z (mm)	W (inch)	Z (inch)
NISSAN Sentra, 4-dr Sedan, *13-	305	610	12	24

