



Thule XT Kit 3144

> Instructions

MITSUBISHI L200, 4-dr Double Cab, 15-

MITSUBISHI Triton, 4-dr Double Cab, 15-

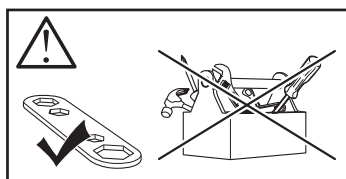

This kit is only for vehicles with fixpoint mounting.

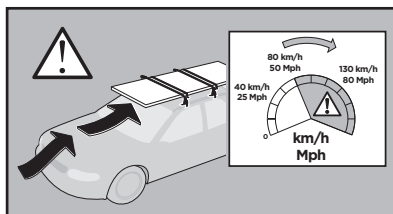
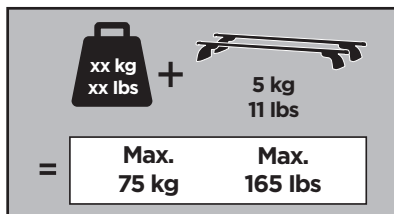
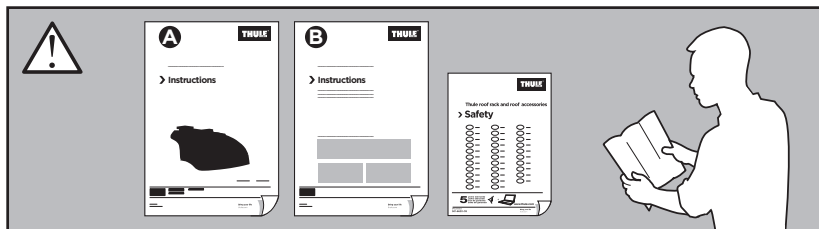

ISO 11154-E

183144

C.20160113
509-3144-01

Bring your life
thule.com

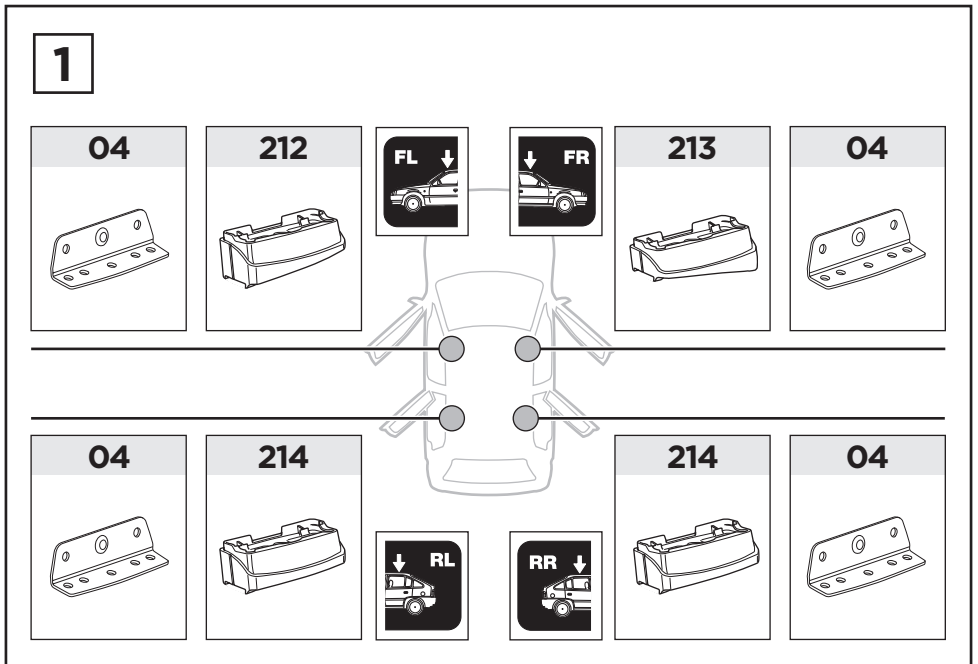
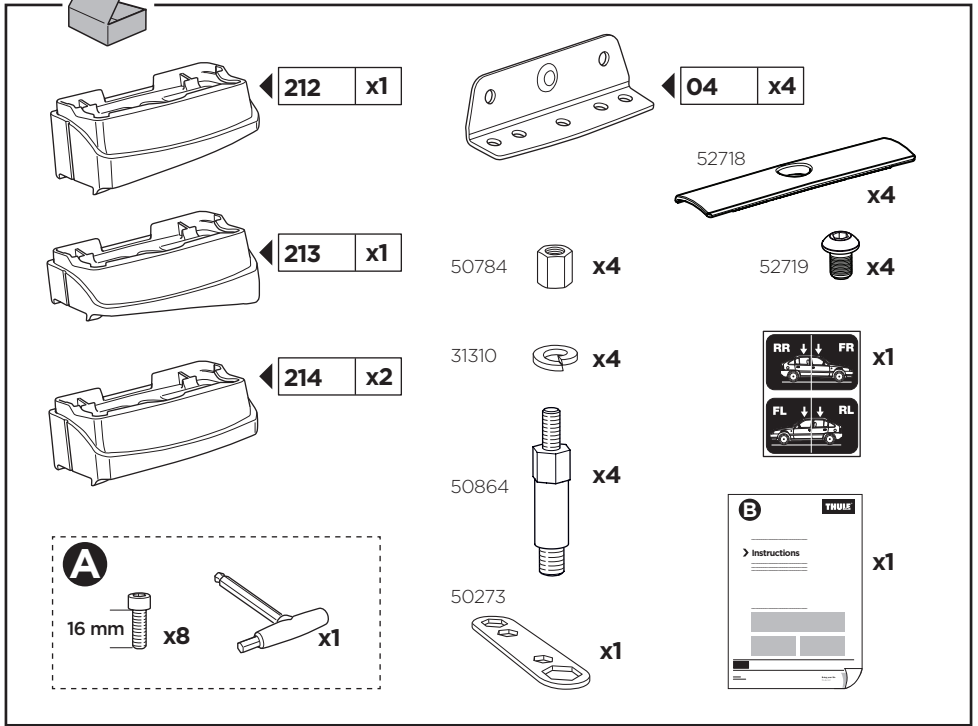

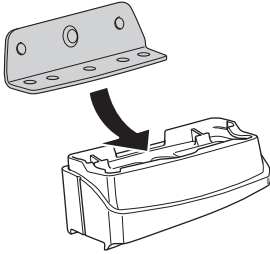
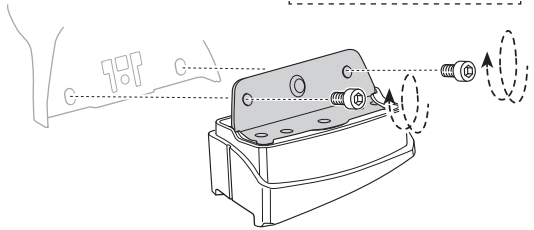
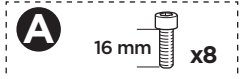
2**A****B**

- | | | |
|-------------------------------------|-------------------------------------|----------------------------------|
| EN Only a few turns | ET Ainult mõni pööre | RO Doar câteva rotiri |
| DE Nur wenige Umdrehungen | LV Tikai daži apgriezieni | HU Csak néhány fordítás |
| FR Quelques tours uniquement | LT Tik keli pasukimai | EL Μόνο λίγες περιστροφές |
| NL Slechts enkele slagen | PL Wystarczy kilka obrotów | TR Yalnızca birkaç tur |
| IT Solo qualche giro | RU Только несколько оборотов | AR بعض دورات فقط |
| ES Sólo algunas vueltas | UK Лише декілька обертів | HE רק מספר סיבובים |
| PT Apenas algumas voltas | BG Само няколко завъртания | ZH 仅几圈 |
| SV Endast några varv | CS Pouze několik otáček | JA 2～3回転のみ |
| DK Kun nogle få omgange | SK Len niekoľko otáčok | KO 몇 번만 돌리면 됨 |
| NO Bare noen få omdreininger | SL Le nekaj obratov | TH เพียงสองสามรอบ |
| FI Vain muutama kierros | HR/BIH Samo nekoliko okreta | |

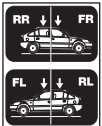
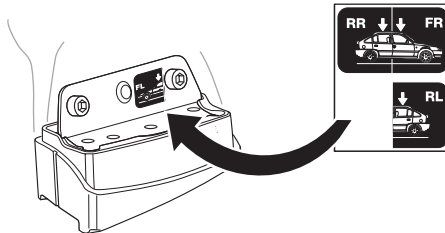
3**x1**

4

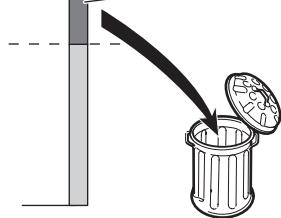
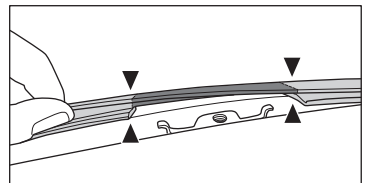
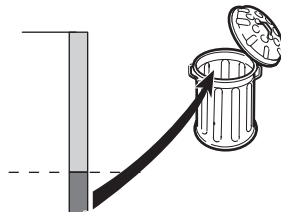
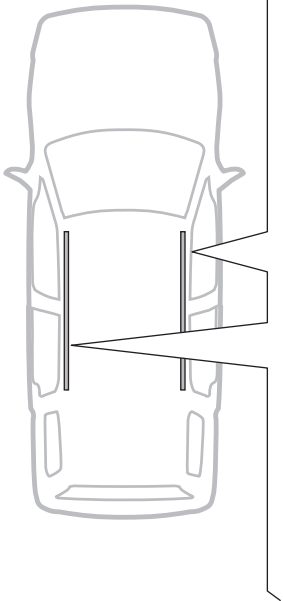
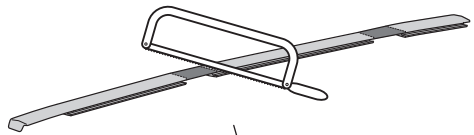
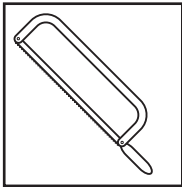
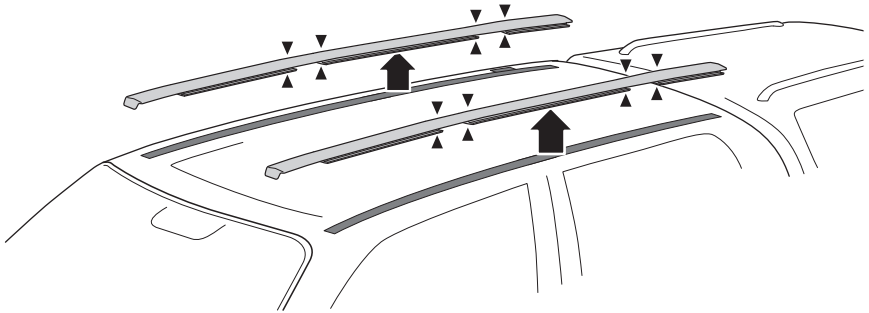

5

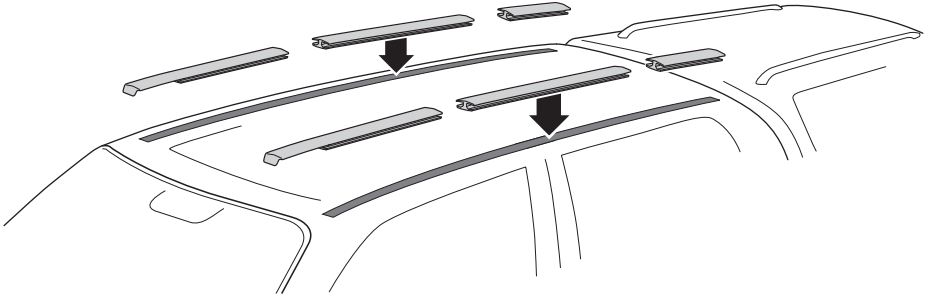

6

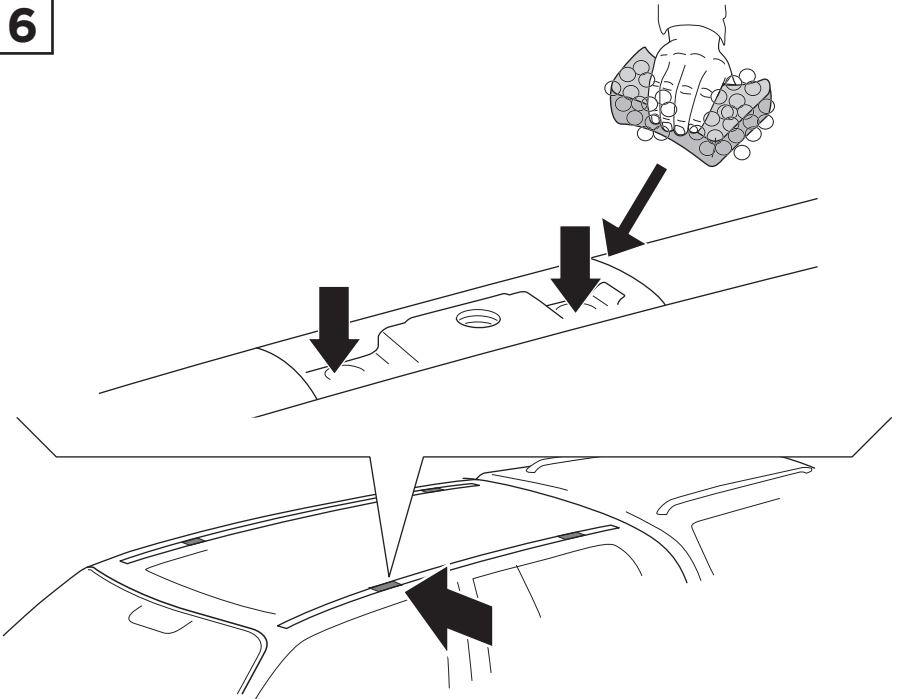

7

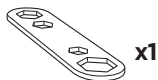

A

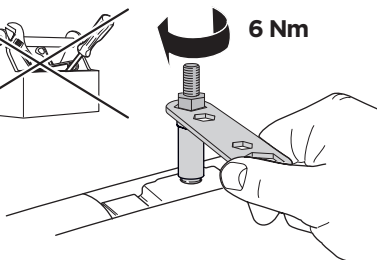
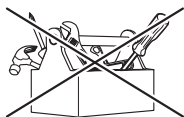
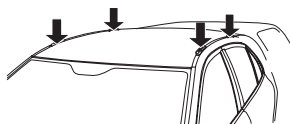

B

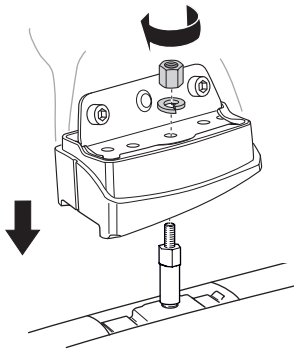

8

A

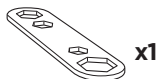
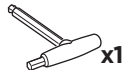

A

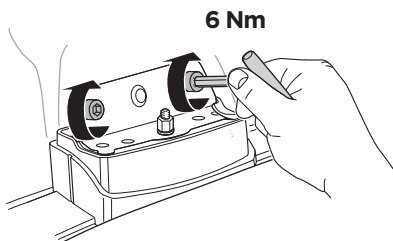

B

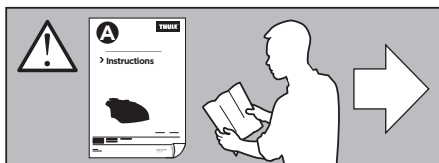
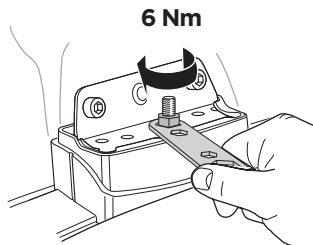

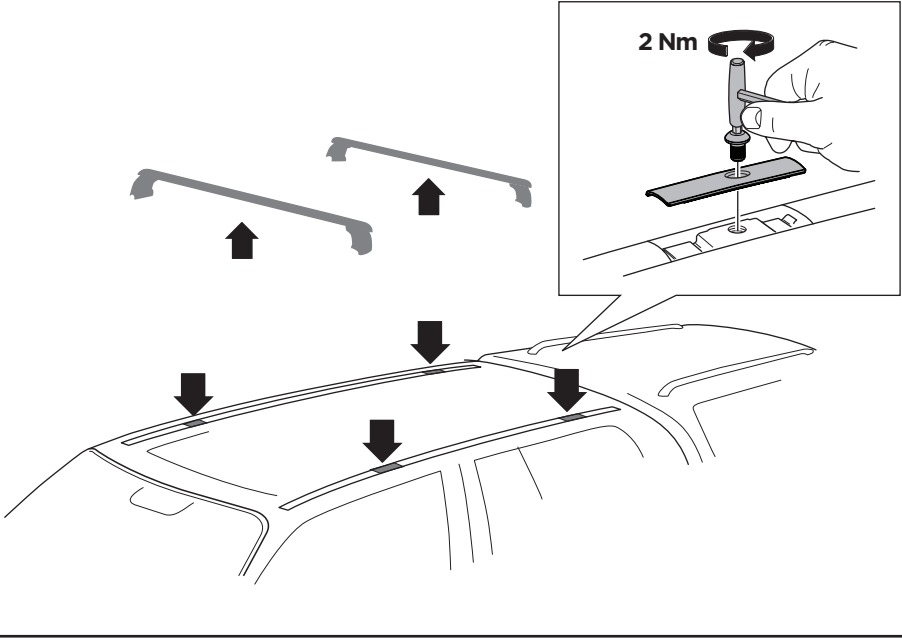
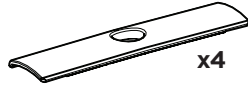
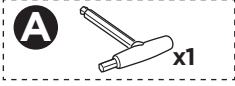



Thule Sweden AB, Box 69, 330 33 Hillerstorp, SWEDEN
Thule Inc., 42 Silvermine Road, Seymour, Connecticut 06483, USA



info@thule.com
Phone: 800-238-2388



www.thule.com