



Thule Rapid System Kit 1856

> Instructions

FIAT 500, 3-dr Hatchback, 07-/*11-

*North America

The diagram is divided into four main sections:

- Top Left:** A dashed box containing an information icon (i), a warning triangle, an illustration of a person reading instructions, and two instruction manuals. Manual B is titled 'Thule Rapid System Kit 1856 > Instructions' and manual A is titled 'Thule Rapid System 754 > Instructions'. An arrow points from manual B to manual A.
- Top Right:** A weight calculation diagram. It shows a bag labeled 'xx kg / xx lbs' plus a rack labeled '7 kg / 15,4 lbs' and two screws labeled '3 kg / 6,6 lbs'. Below this, an equals sign leads to a box containing 'Max. 50 kg' and 'Max. 110 lbs'.
- Bottom Left:** A dashed box containing a warning triangle, three instruction manuals (A, B, and Security), and an illustration of a person reading a manual.
- Bottom Right:** A diagram of a car with arrows indicating the rack's position on the roof. A speedometer graphic shows a warning triangle between 40 km/h (25 Mph) and 80 km/h (50 Mph), with a maximum limit of 130 km/h (80 Mph).

ISO 11154-E

141856
C.20170516
519-1856-02

Bring your life
thule.com

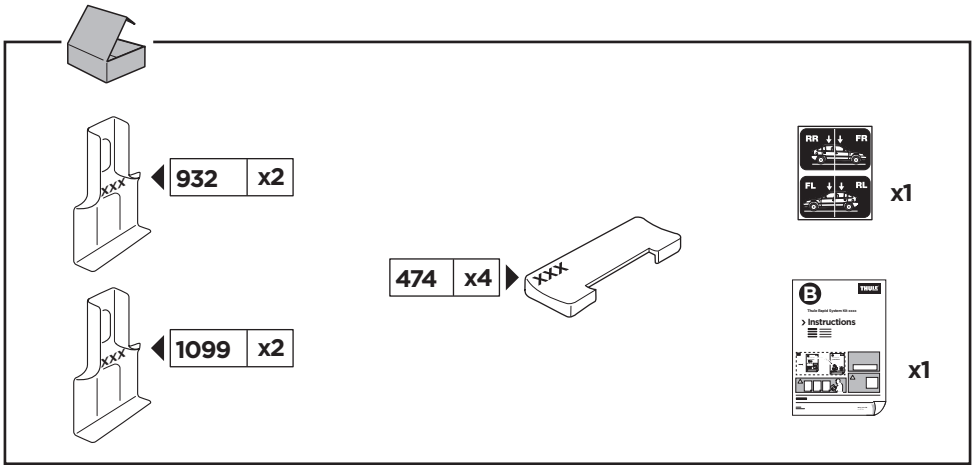

1

	X (scale)	X (mm)	X (inch)
FIAT 500, 3-dr Hatchback, 07-/*11-	33,5	986	38 ⁷ / ₈

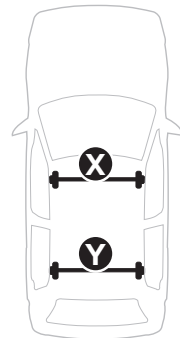
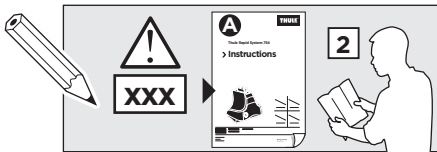

	Y (scale)	Y (mm)	Y (inch)
FIAT 500, 3-dr Hatchback, 07-/*11-	28	931	36 ⁵ / ₈

2

SRA

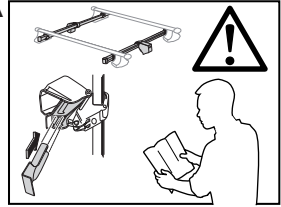

FIAT 500, 3-dr Hatchback, 07-/ *11-

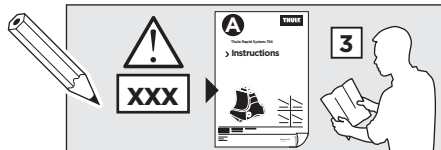
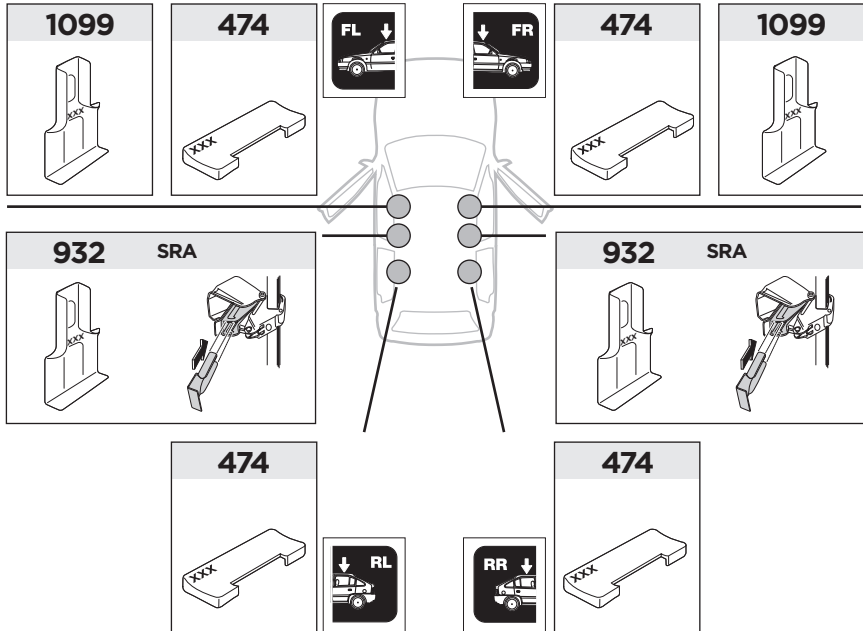

3

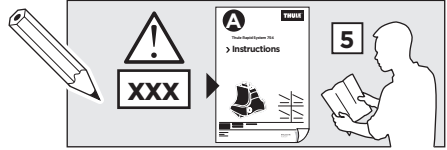

	W (mm)	Z (mm)	Y (mm)	W (inch)	Z (inch)	Y (inch)
FIAT 500, 3-dr Hatchback, 07-/*11-	250	600	270	9 7/8	23 5/8	10 5/8

