

# Kit 1491

TOYOTA Alphard, 5-dr MPV, 08–  
TOYOTA Vellfire, 5-dr MPV, 08–

480R  
754

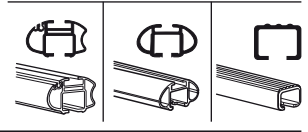
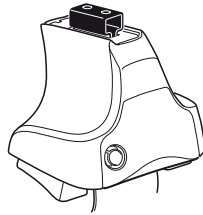

480

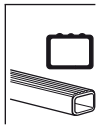
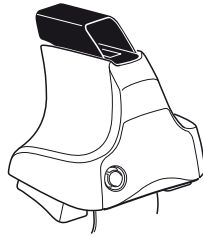

750

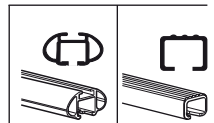
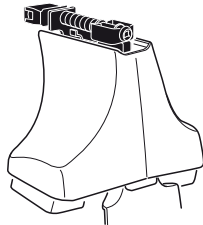

**Kit**



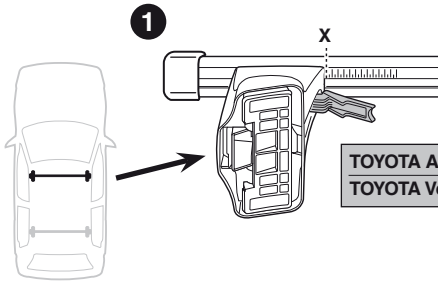

	X
TOYOTA Alphard, 5-dr MPV, 08-	58
TOYOTA Vellfire, 5-dr MPV, 08-	58

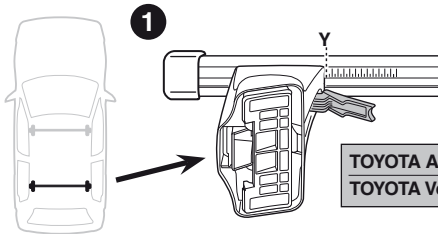

	Y
TOYOTA Alphard, 5-dr MPV, 08-	57,5
TOYOTA Vellfire, 5-dr MPV, 08-	57,5

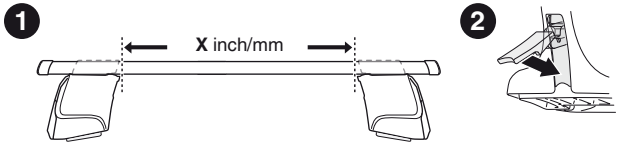
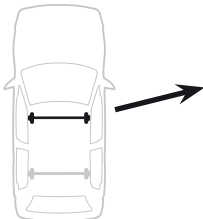
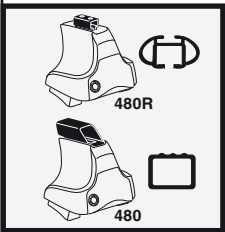

	X inch	X mm
TOYOTA Alphard, 5-dr MPV, 08-	48 1/2"	1231 mm
TOYOTA Vellfire, 5-dr MPV, 08-	48 1/2"	1231 mm

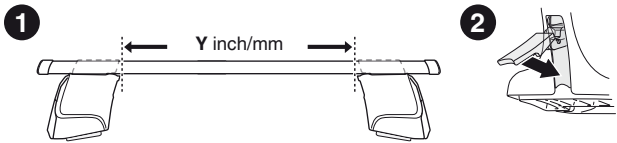
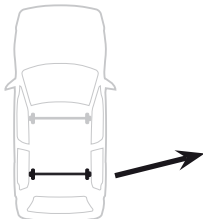

	Y inch	Y mm
TOYOTA Alphard, 5-dr MPV, 08-	48 1/4"	1226 mm
TOYOTA Vellfire, 5-dr MPV, 08-	48 1/4"	1226 mm

# 4

TOYOTA Alphard, 5-dr MPV, 08–  
 TOYOTA Vellfire, 5-dr MPV, 08–

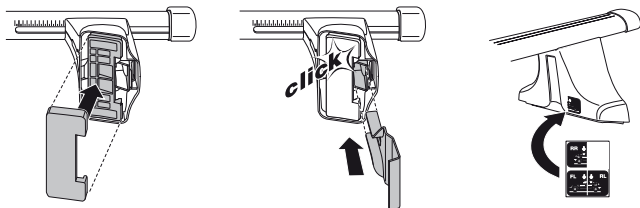
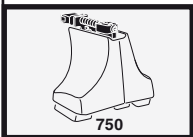
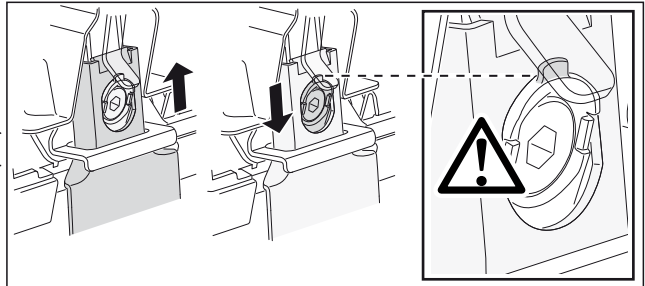
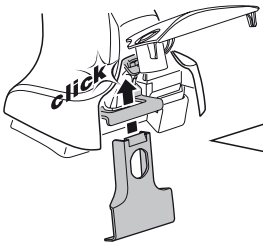
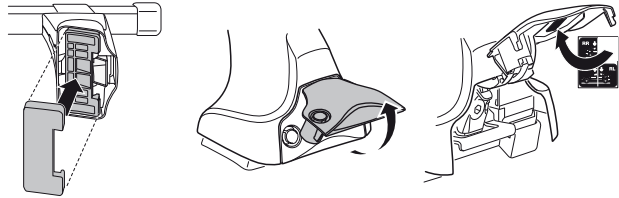
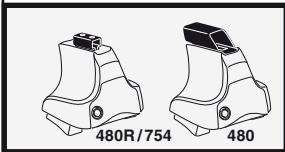
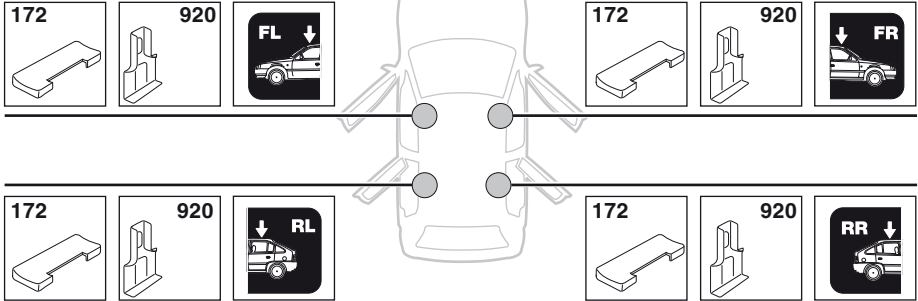

5

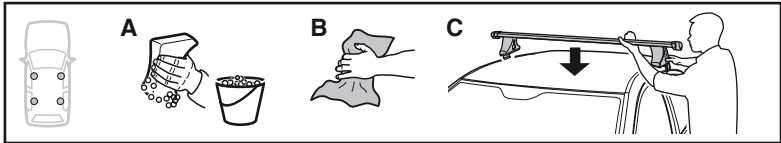

	X mm	Y mm	X inch	Y inch
<b>TOYOTA Alphard, 5-dr MPV, 08-</b>	765 mm	755 mm	30 1/8"	29 3/4"
<b>TOYOTA Vellfire, 5-dr MPV, 08-</b>	765 mm	755 mm	30 1/8"	29 3/4"

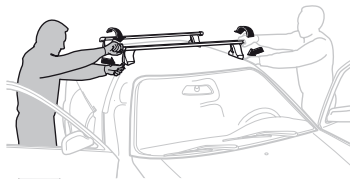
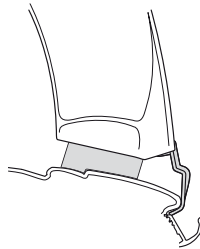
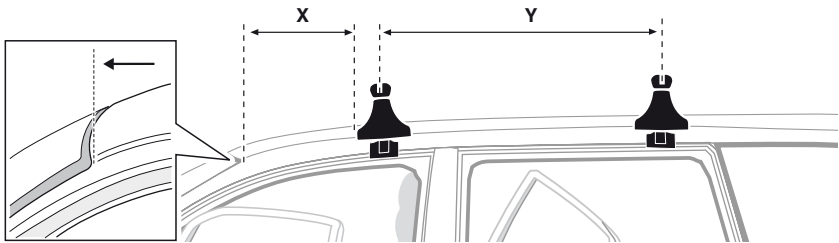

**GB/US** Tighten alternately

**D** Die Schrauben abwechselnd anziehen

**F** Serrer alternativement chaque côté

**NL** Afwisselend aan de linker- en de rechterkant aandraaien

**I** Alternare il serraggio delle viti

**E** Apretar alternativamente

**PT** Aperte alternadamente

**S** Dra åt växelvis

**FIN** Kierrä vuorotellen

**EST** Pinguldage vaheldumisi

**LAT** Pielvelciet pamišus

**LIT** Užsukinėkite pakaitomis

**PL** Śruby dokręcaj naprzemiennie

**RU** Затягивайте попеременно

**CZ** Pokręťta bagażníka dokręcaj dokręcaj naprzemiennie.

**SK** Doťahujte striedavo

**SLO** Privijajte izmenično.

**HR** Naizmjenično zategnite

**HU** Egymástól függetlenül szorítandó

**GR** Σφίγγετε εναλλάξ

**TR** Dönüşümlü sıkın

**中文** 交替拧紧

**한국어** 번갈아 가며 조이십시오.

**日本語** 交互に締め付けてください。

**ไทย** ชั้้นโน้แบบสลับ

6



480R/754



480

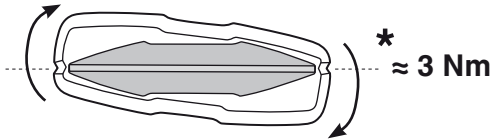
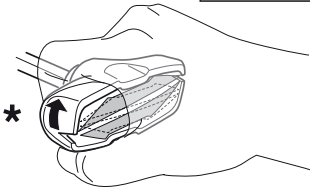
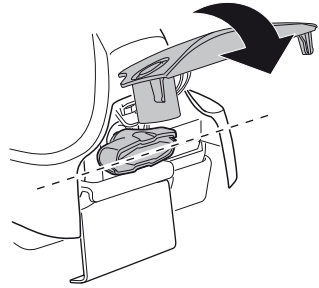
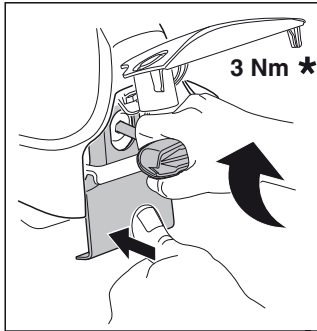

750

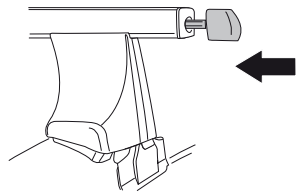
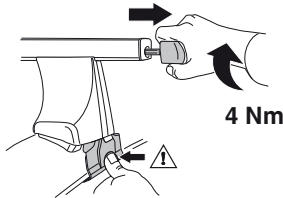

i



1

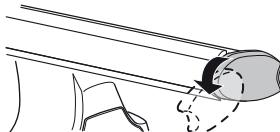

2

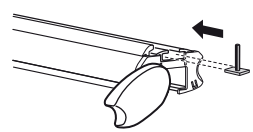

i

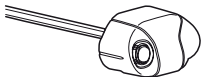

1

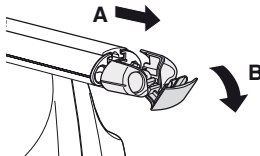

2

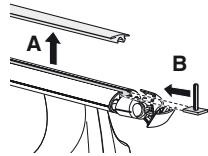

i



1

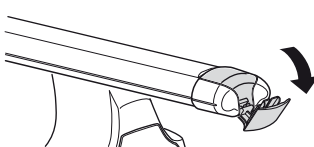

2

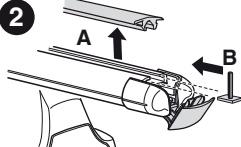

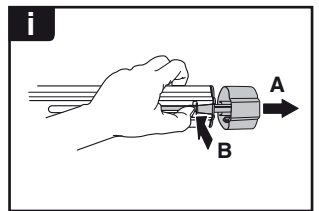
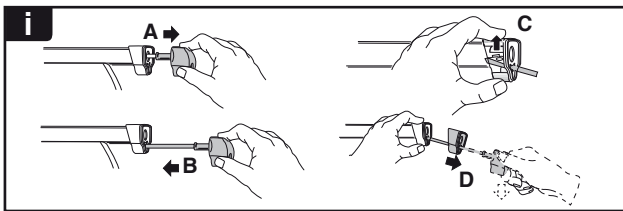
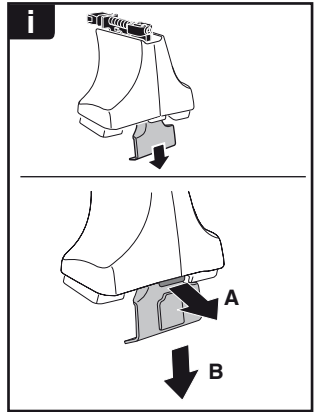
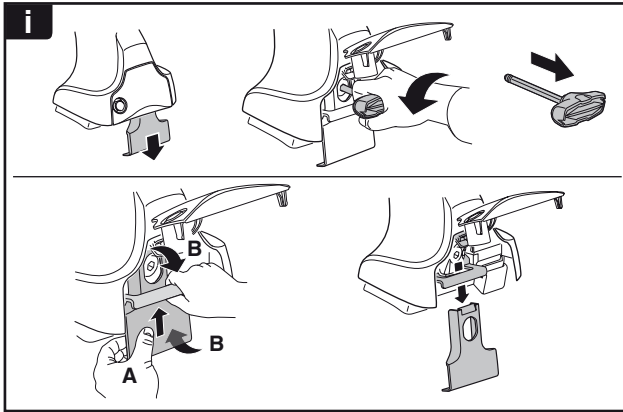

**THULE**  
SWEDEN  
**ONE  
KEY  
SYSTEM**

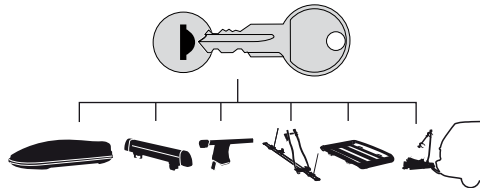

- 544 (x4)
- 596 (x6)
- 588 (x8)
- NA 510 (x10)
- EUR 452 (x12)
- ASIA



WW ▶ Thule Sweden AB, Box 69, 330 33 Hillerstorp, SWEDEN  
NA ▶ Thule Inc., 42 Silvermine Road, Seymour, Connecticut 06483, USA

info@thule.com  
customer.service@thule.com

www.thule.com