



Thule Rapid System Kit 4067 Thule Podium Kit 4067

> Instructions

HONDA HR-V, 5-dr SUV, 15-
HONDA Vezel, 5-dr SUV, 14-

This kit is only for vehicles with flush side railing.

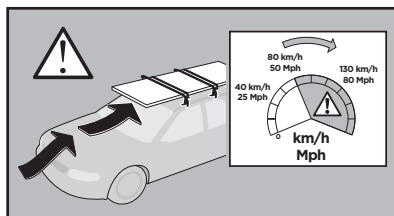
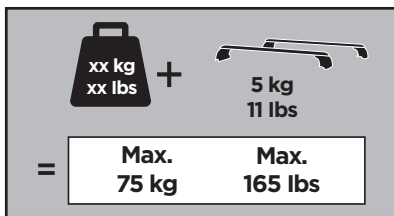
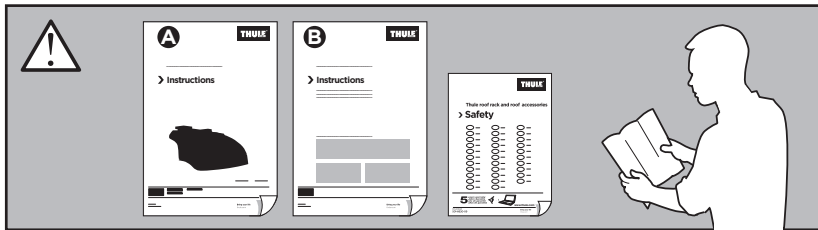

ISO 11154-E

184067
C.20150311
509-4067-01

Bring your life
thule.com

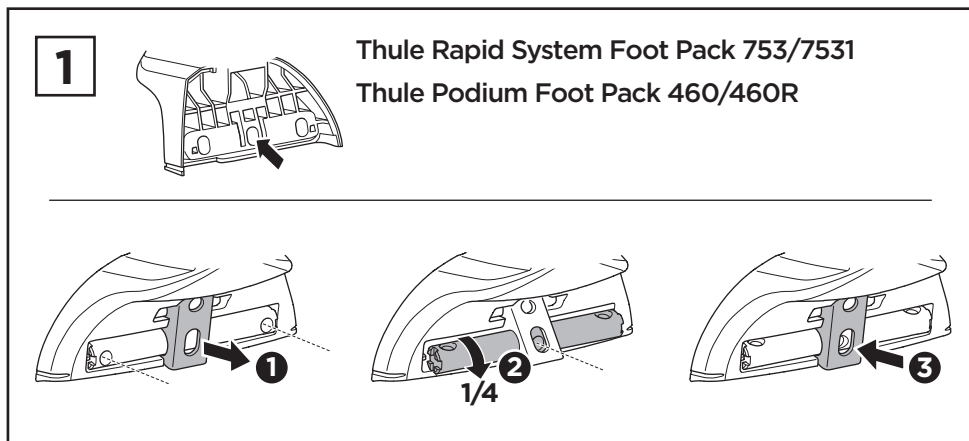
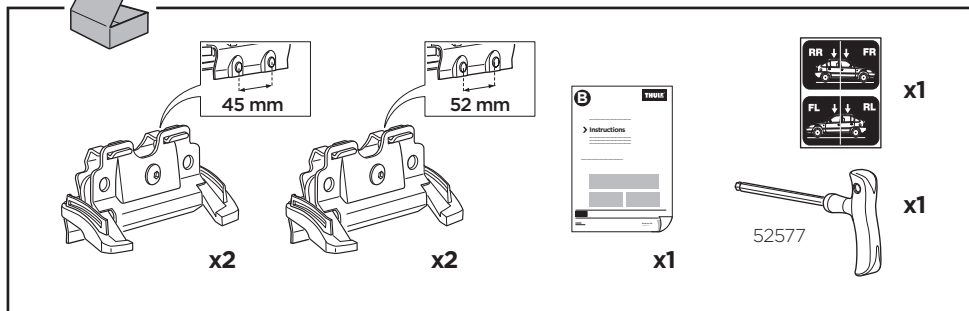

2

EN Only a few turns

DE Nur wenige Umdrehungen

FR Quelques tours uniquement

NL Slechts enkele slagen

IT Solo qualche giro

ES Sólo algunas vueltas

PT Apenas algumas voltas

SV Endast några varv

DK Kun nogle få omgange

NO Bare noen få omdreininger

FI Vain muutama kierros

ET Ainult mõni pööre

LV Tikai daži apgriezieni

LT Tik keli pasukimai

PL Wystarczy kilka obrotów

RU Только несколько оборотов

UK Лише декілька обертів

BG Само няколко завъртания

CS Pouze několik otáček

SK Len niekoľko otáčok

SL Le nekaj obratov

HR/BiH Samo nekoliko okreta

RO Doar câteva rotiri

HU Csak néhány fordítás

EL Μόνο λίγες περιστροφές

TR Yalnızca birkaç tur

AR بعض دورات فقط

HE רק מספר סיבובים

ZH 仅几圈

JA 2～3回転のみ

KO 몇 번만 돌리면 됨

TH เพียงสองสามรอบ

3

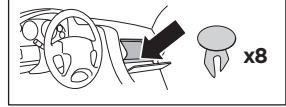
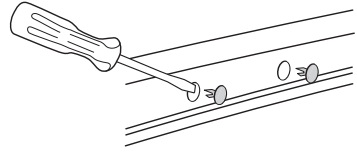
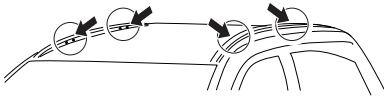

4

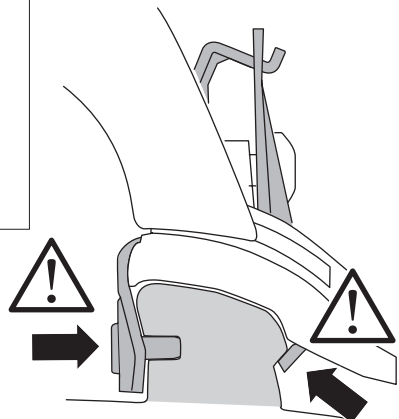
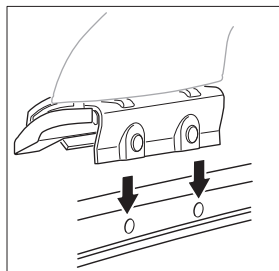
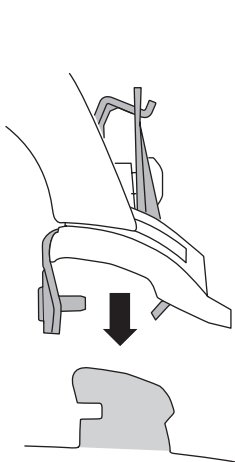
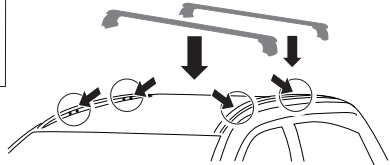
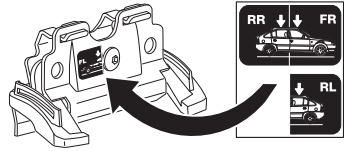
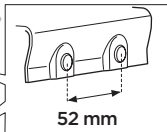
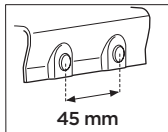

5

- | | | | |
|-----------|---|---------------|---|
| EN | Tighten alternately | UK | Затягти по чергово |
| DE | Die Schrauben abwechselnd anziehen | BG | Затегнете последователно |
| FR | Serrer alternativement chaque côté | CS | Pokřetla багаžníka dokřečaj dokřečaj naprzemiennie. |
| NL | Afwisselend aan de linker- en de rechterkant aandraaien | SK | Dotahujte striedavo |
| IT | Alternare il serraggio delle viti | SL | Privijajte izmenično |
| ES | Apretar alternativamente | HR/BIH | Naizmjenično zategnite |
| PT | Aperte alternadamente | RO | Strângeți alternativ |
| SV | Dra åt växelvis | HU | Egy mástól függetlenül szorítandó |
| DK | Spænd skiftevis | EL | Σφίγγετε εναλλάξ |
| NO | Trekk til vekselvis | TR | Dönüşümlü sıkın |
| FI | Kierrä vuorotellen | | |
| ET | Pinguldage vaheldumisi | | |
| LV | Pievelciet pamīšus | | |
| LT | Užsukinėkite pakaitomis | ZH | 交替拧紧 |
| PL | Śruby dokręcaj naprzemiennie | JA | 左右交互に締めつけてください |
| RU | Затягивайте попеременно | KO | 번갈아 조이기 |
| | | TH | ขันในแบบสลับ |

إحكام الربط بالتناوب **AR**חזק לסימון **HE**