

Kit 1458

FORD Fusion, 5-dr Hatchback, 06-12

FORD Figo, 5-dr Hatchback, 10-

480R
754

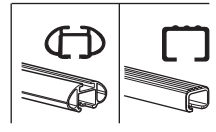
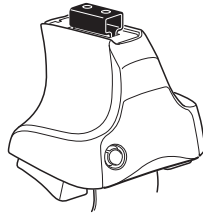

480

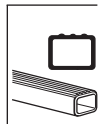
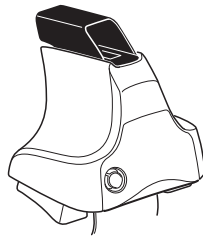

750

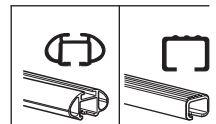
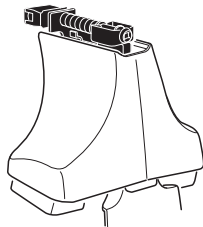

Kit

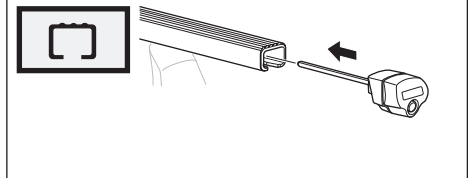
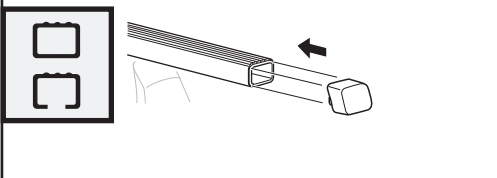
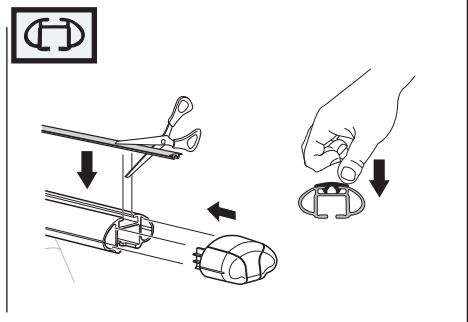
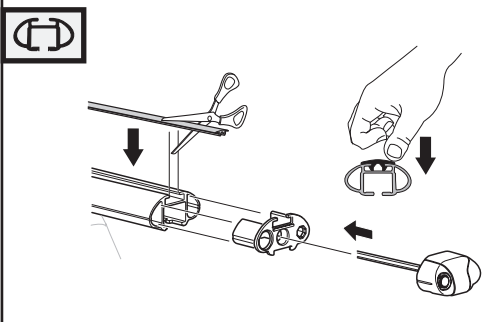
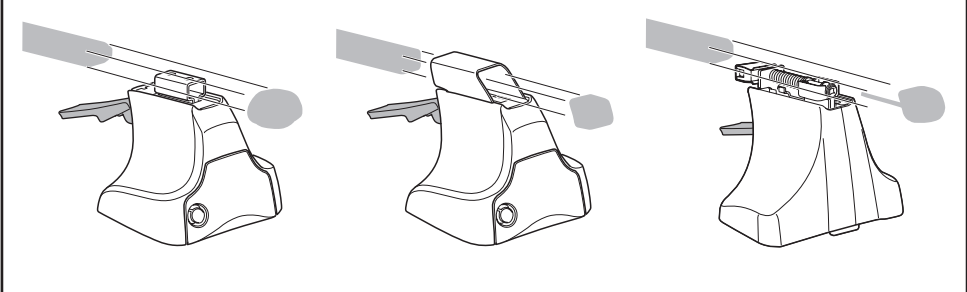
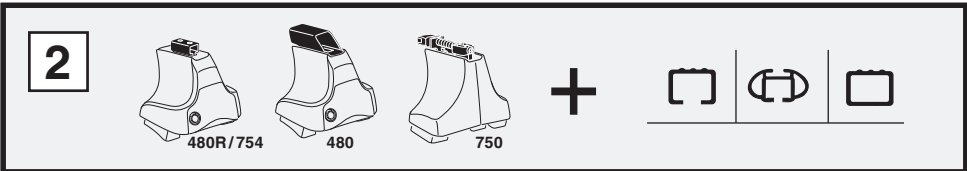
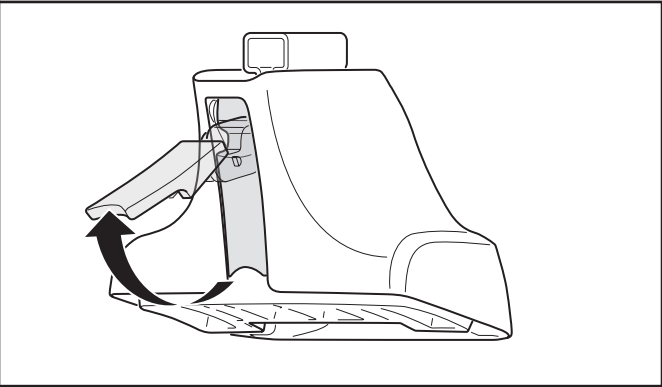
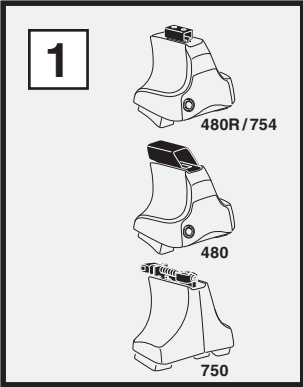

3

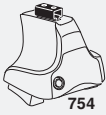

754



750

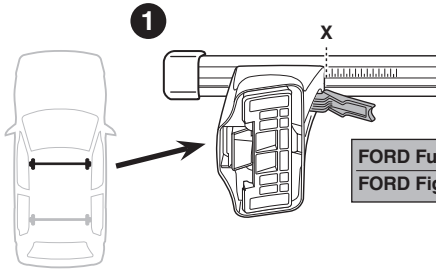

	X
FORD Fusion, 5-dr Hatchback, 06-12	35,5
FORD Figo, 5-dr Hatchback, 10-	33,5

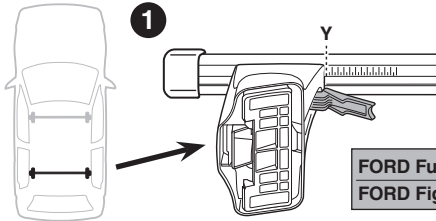

	Y
FORD Fusion, 5-dr Hatchback, 06-12	32,5
FORD Figo, 5-dr Hatchback, 10-	29,5

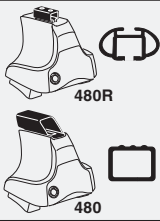

480R



480

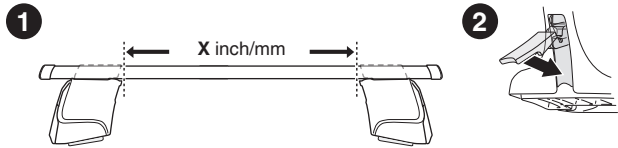

	X inch	X mm
FORD Fusion, 5-dr Hatchback, 06-12	39 ⁵ / ₈ "	1006 mm
FORD Figo, 5-dr Hatchback, 10-	38 ⁷ / ₈ "	986 mm

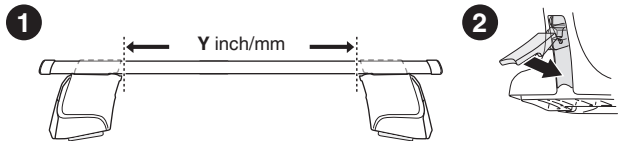

	Y inch	Y mm
FORD Fusion, 5-dr Hatchback, 06-12	38 ³ / ₈ "	976 mm
FORD Figo, 5-dr Hatchback, 10-	37 ¹ / ₄ "	946 mm

4

FORD Fusion, 5-dr Hatchback, 06-12

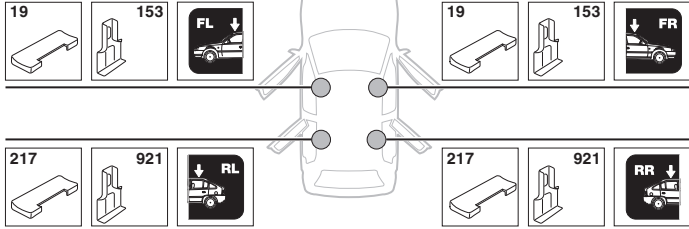

FORD Figo, 5-dr Hatchback, 10-

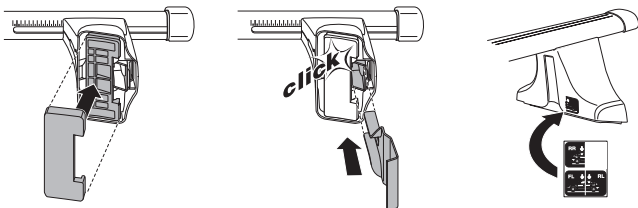
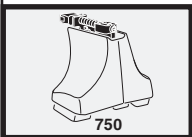
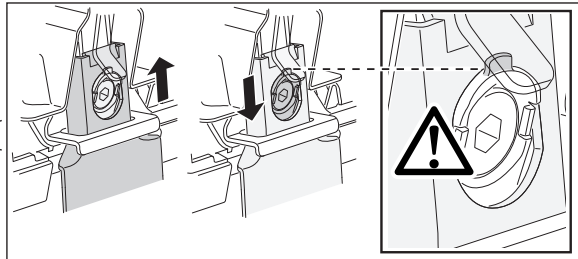
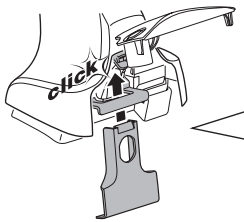
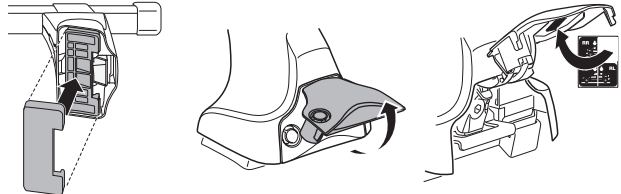
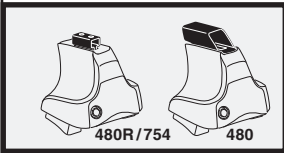
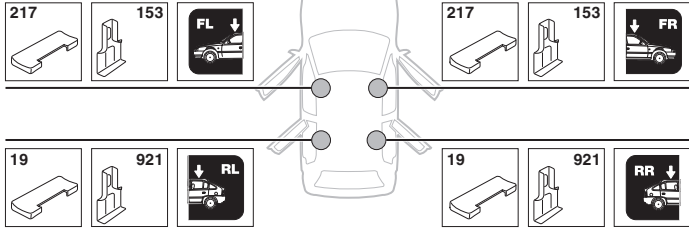

5

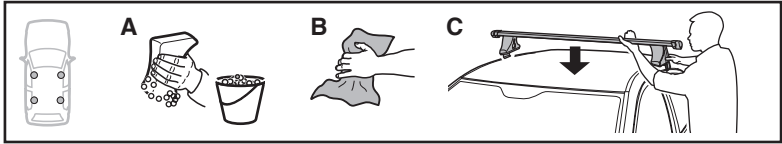

	X mm	Y mm	X inch	Y inch
FORD Fusion, 5-dr Hatchback, 06-12	300 mm	700 mm	11 3/4"	27 1/2"
FORD Figo, 5-dr Hatchback, 10-	300 mm	700 mm	11 3/4"	27 1/2"

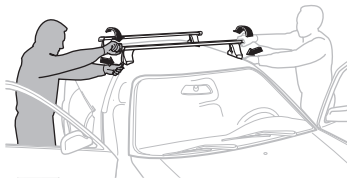
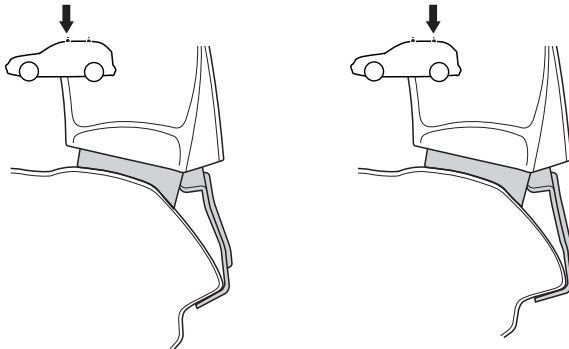
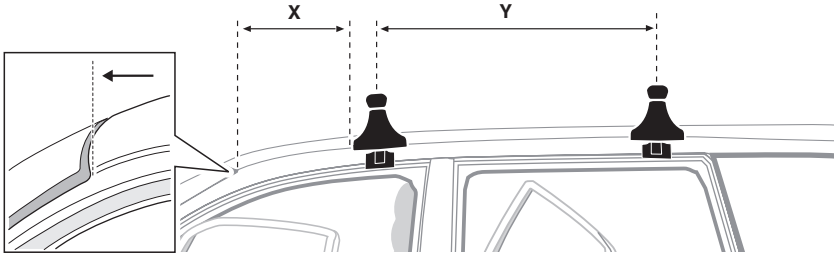

GB/US Tighten alternately

D Die Schrauben abwechselnd anziehen

F Serrer alternativement chaque côté

NL Afwisselend aan de linker- en de rechterkant aandraaien

I Alternare il serraggio delle viti

E Apretar alternativamente

PT Aperte alternadamente

S Dra åt växelvis

FIN Kierrä vuorotellen

EST Pinguldage vaheldumisi

LAT Pieveļciet pamišus

LIT Užsukinėkite pakaitomis

PL Śruby dokręcaj naprzemiennie

RU Затягивайте попеременно

CZ Pokręťta багаžníka dokręcaj dokręcaj naprzemiennie.

SK Doťahujte striedavo

SLO Privijajte izmenično.

HR Naizmjenično zategnite

HU Egymástól függetlenül szorítandó

GR Σφιγγετε εναλλάξ

TR Dönüşümlü sıkın

中文 交替拧紧

한국어 번갈아 가며 조이십시오.

日本語 交互に締め付けてください。

ไทย ชันโนแบบสลับ

6



480R/754



480

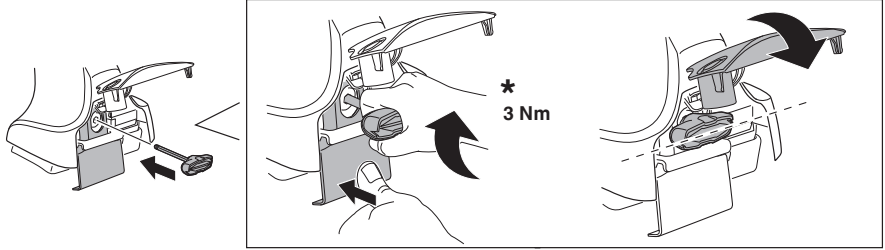

*
3 Nm

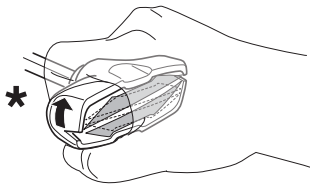

*

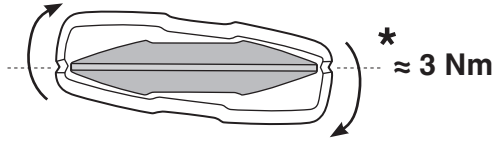

*
≈ 3 Nm

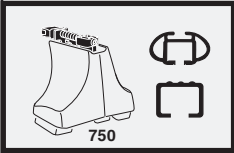
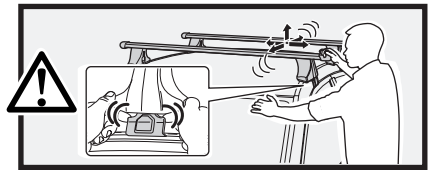

750

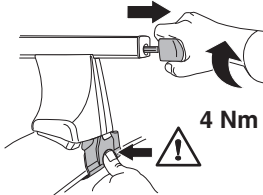

4 Nm

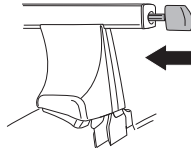

7



x1
17 mm

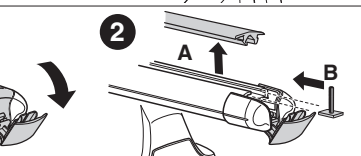
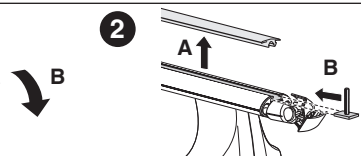
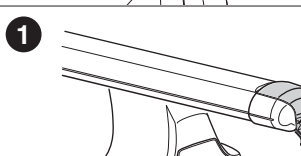
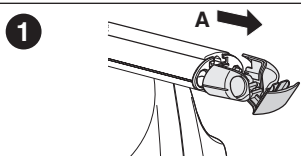
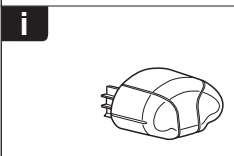
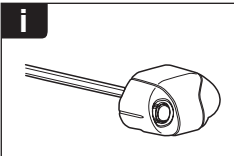
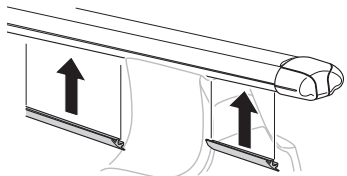

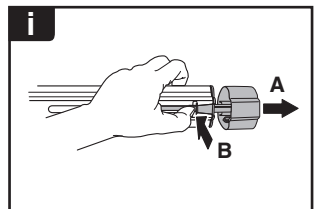
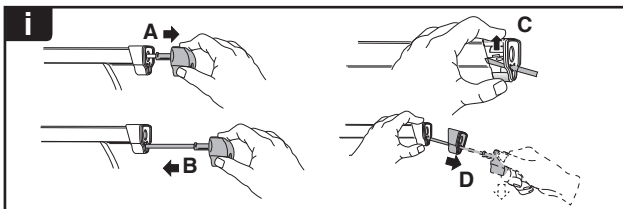
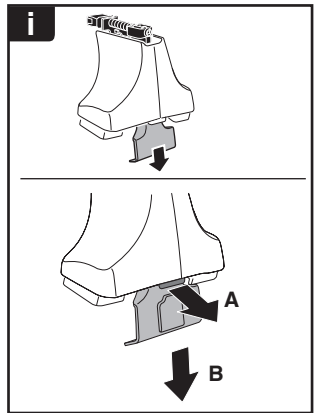
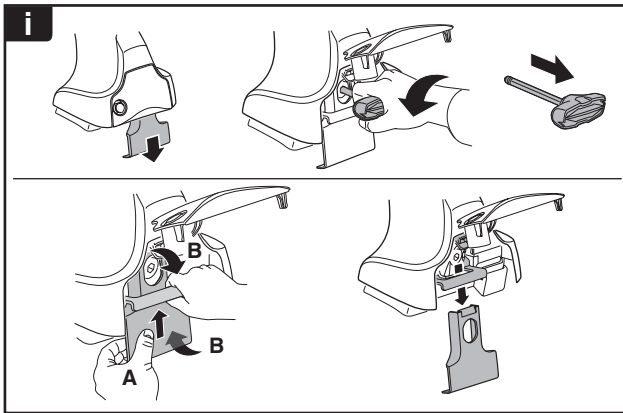
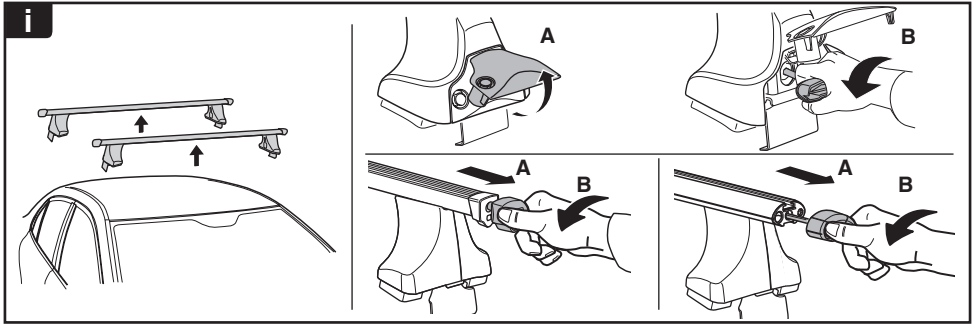

THULE
SWEDEN
**ONE
KEY
SYSTEM**

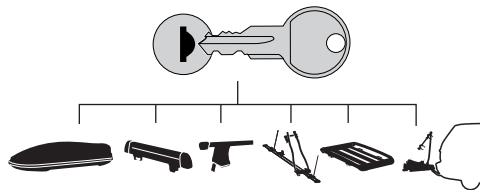

- 544 (x4)
- 596 (x6)
- 588 (x8)
- NA 510 (x10)
- EUR 452 (x12)
- ASIA

