

Kit 1546

LEXUS RX 350, 5-dr SUV, 10-*

LEXUS RX 450h, 5-dr SUV, 10-*

TOYOTA Venza, 5-dr SUV, 09- (Excludes Models w / Glass Roof)*

* w/o factory rack

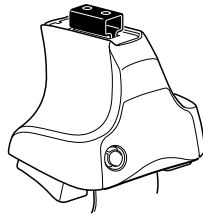

754 Rapid System
480R Rapid Traverse (North America)

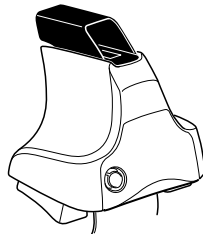
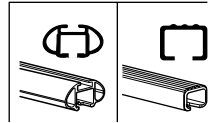

480 Traverse (North America)

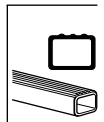

754 Rapid System x4

480R Rapid Traverse (North America) x4

754 Rapid System

480R Rapid Traverse (North America)

480 Traverse (North America) x4

(North America)

x2

x2 23 mm

x2

x2

x2

x4

x4

x1 17 mm

x2 23 mm

x2

x2

x2

x2

x2

568 x4

06 x2

46 x2

FR ↓ ↓ FR

FL ↓ ↓ RL

x1

1



2



754 Rapid System
480R Rapid Traverse
(North America)



x4



x4



x4



480 Traverse
(North America)



x4

3



754 Rapid System

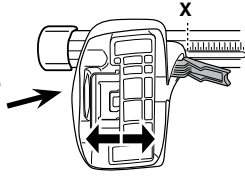

	X
LEXUS RX 350 , 5-dr SUV, 10–	45
LEXUS RX 450h , 5-dr SUV, 10–	45
TOYOTA Venza , 5-dr SUV, 09–	45

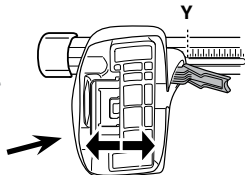

	Y
LEXUS RX 350 , 5-dr SUV, 10–	45
LEXUS RX 450h , 5-dr SUV, 10–	45
TOYOTA Venza , 5-dr SUV, 09–	45

3



480R Rapid Traverse



480 Traverse

(North America)

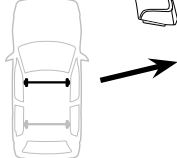

	X inch	X mm
LEXUS RX 350 , 5-dr SUV, 10–	43 1/4"	1100 mm
LEXUS RX 450h , 5-dr SUV, 10–	43 1/4"	1100 mm
TOYOTA Venza , 5-dr SUV, 09–	43 1/4"	1100 mm

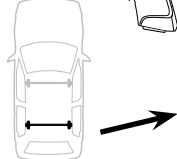
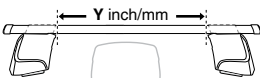

	Y inch	Y mm
LEXUS RX 350 , 5-dr SUV, 10–	43 1/4"	1100 mm
LEXUS RX 450h , 5-dr SUV, 10–	43 1/4"	1100 mm
TOYOTA Venza , 5-dr SUV, 09–	43 1/4"	1100 mm

4



5

LEXUS RX 350, 5-dr SUV, 10-
LEXUS RX 450h, 5-dr SUV, 10-
TOYOTA Venza, 5-dr SUV, 09-

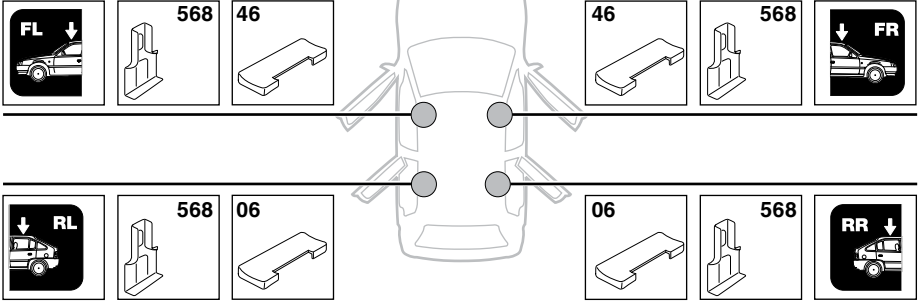

6

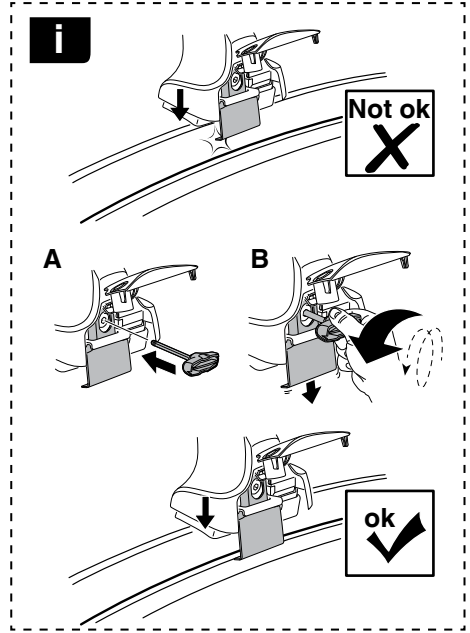

	X mm	Y mm	X inch	Y inch
LEXUS RX 350, 5-dr SUV, 10–	292 mm	700 mm	11 1/2"	27 1/2"
LEXUS RX 450h, 5-dr SUV, 10–	292 mm	700 mm	11 1/2"	27 1/2"
TOYOTA Venza, 5-dr SUV, 09–	292 mm	700 mm	11 1/2"	27 1/2"

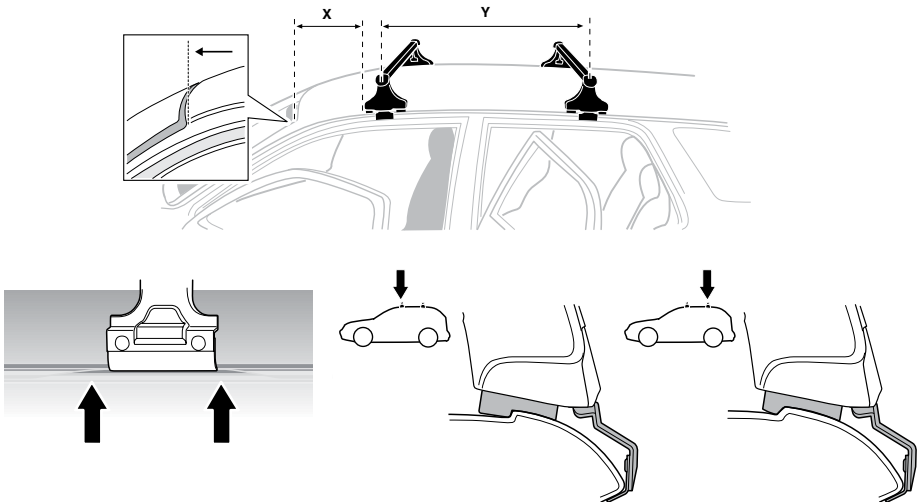

7

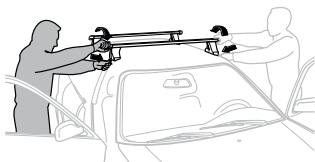

GB/US Tighten alternately
 D Die Schrauben abwechselnd anziehen
 F Serrer alternativement chaque côté
 NL Afwisselend aan de linker- en de rechterkant aandraaien
 I Alternare il serraggio delle viti
 E Apertar alternativamente
 PT Aperte alternadamente
 S Dra åt växelvis
 FIN Kierrä vuorotellen
 EST Pinguldage vaheldumisi
 LAT Pieļieciet pamišus
 LIT Užsukinėkite pakaitomis
 PL Śruby dokręcaj naprzemiennie
 RU Затягивайте попеременно

CZ Pokręťta bagażnika dokręcaj naprzemiennie.
 SK Dofahajte striedavo
 SLO Privijajte izmenično.
 HR Naizmjenočno zategnite
 HU Egymástól függetlenül szorítandó
 GR Σφιγίγτες εναλλάξ
 TR Dönüşümlü sıkın

中文 交替拧紧

한국어 번갈아 가며 조이십시오.

日本語 交互に締め付けてください。

ไทย ชันในแบบสลับ

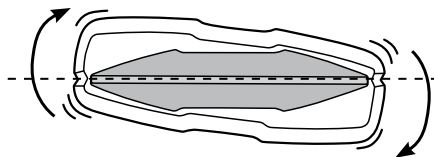
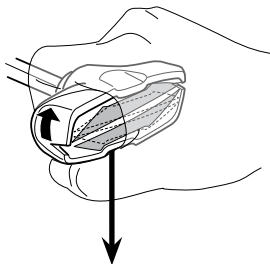
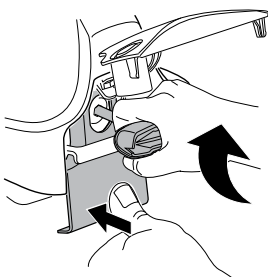
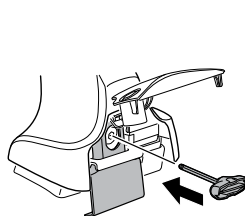

≈ 3 Nm

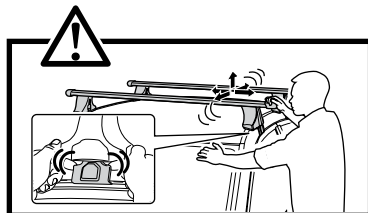
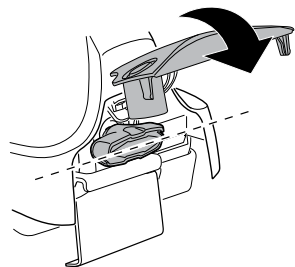

8



x1
17 mm

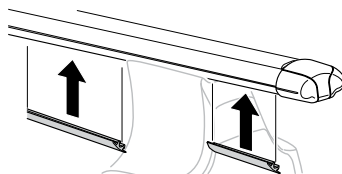
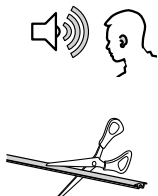



THULE
SWEDEN
**ONE
KEY
SYSTEM**



		544	(x4)
		596	(x6)
		588	(x8)
NA		510	(x10)
EUR		452	(x12)
ASIA			



WW ▶ Thule Sweden AB, Box 69, 330 33 Hillerstorp, SWEDEN
NA ▶ Thule Inc., 42 Silvermine Road, Seymour, Connecticut 06483, USA

info@thule.com
customer.service@thule.com

www.thule.com