

# Kit 1104

RENAULT Espace, 5-dr MPV, 98-02

480R  
754

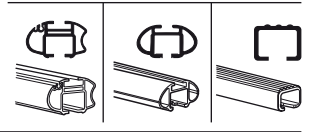
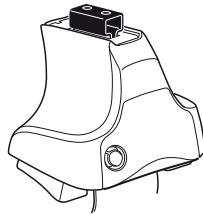

480

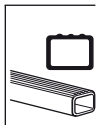
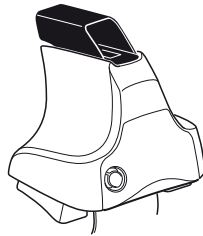

750

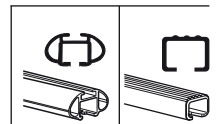
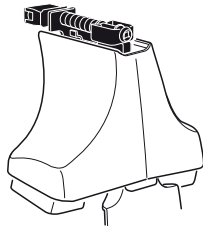

**Kit**



**3**



754

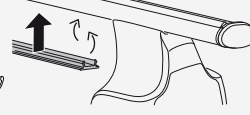
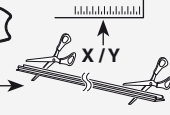

750



**1**

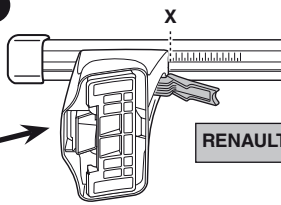
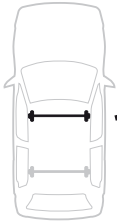

**2**

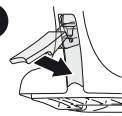

RENAULT Espace, 5-dr MPV, 98-02

X

48

**1**

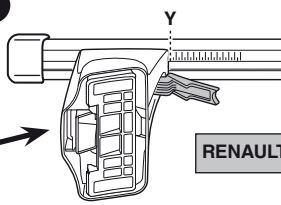

**2**

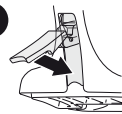

RENAULT Espace, 5-dr MPV, 98-02

Y

47,5



480R



480

**1**

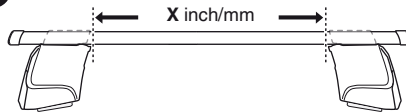

**2**



RENAULT Espace, 5-dr MPV, 98-02

X inch

X mm

44 1/2"

1131 mm

**1**

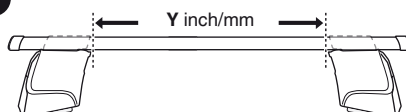

**2**

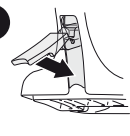

RENAULT Espace, 5-dr MPV, 98-02

Y inch

Y mm

44 3/8"

1126 mm

4

RENAULT Espace, 5-dr MPV, 98-02

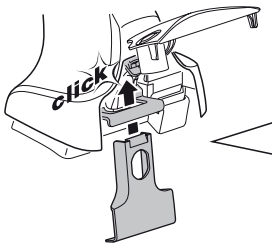
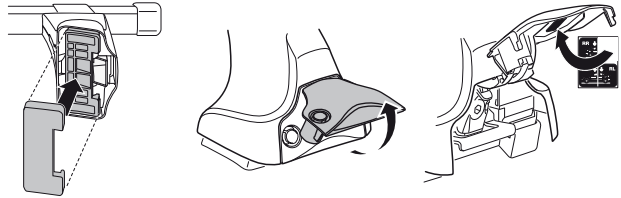
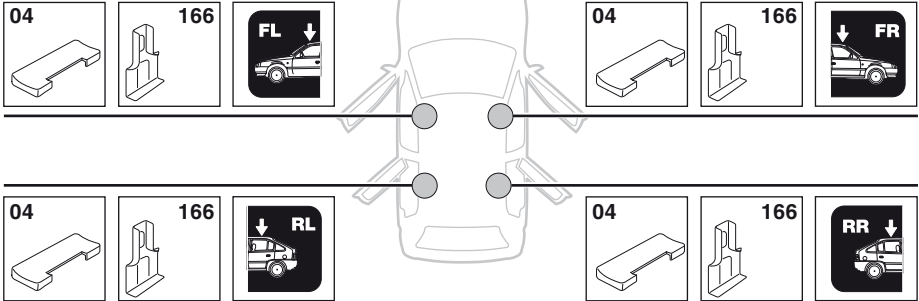

5



	X mm	Y mm	X inch	Y inch
<b>RENAULT Espace, 5-dr MPV, 98-02</b>	<b>300 mm</b>	<b>700 mm</b>	<b>11 3/4"</b>	<b>27 1/2"</b>

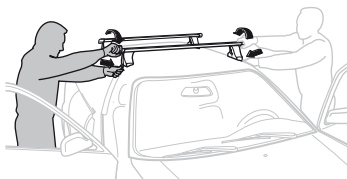
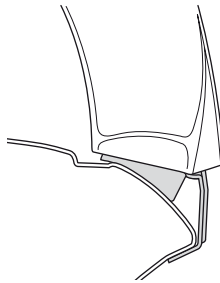
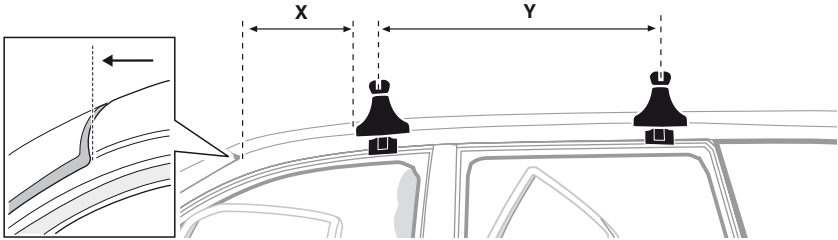

**GB/US** Tighten alternately

**D** Die Schrauben abwechselnd anziehen

**F** Serrer alternativement chaque côté

**NL** Afwisselend aan de linker- en de rechterkant aandraaien

**I** Alternare il serraggio delle viti

**E** Apertar alternativamente

**PT** Aperte alternadamente

**S** Dra åt växelvis

**FIN** Kierrä vuorotellen

**EST** Pinguldage vaheldumisi

**LAT** Pielieciet pamišus

**LIT** Užsukinėkite pakaitomis

**PL** Śruby dokręcaj naprzemiennie

**RU** Затягивайте попеременно

**CZ** Pokręťta bagažníka dokręcaj dokręcaj naprzemiennie.

**SK** Doťahujte striedavo

**SLO** Privijajte izmenično.

**HR** Naizmjenično zategnite

**HU** Egymástól függetlenül szorítandó

**GR** Σφιγγετε εναλλάξ

**TR** Dönüşümlü sıkın

**中文** 交替拧紧

**한국어** 번갈아 가며 조이십시오.

**日本語** 交互に締め付けてください。

**ไทย** ชันโนแบบสลับ

6



480R/754



480

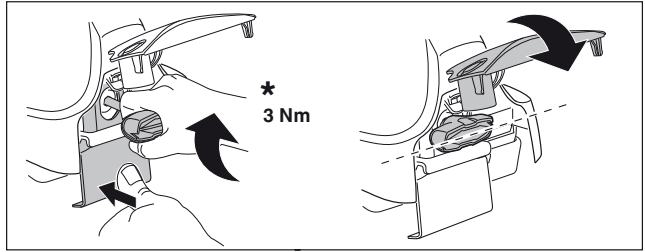
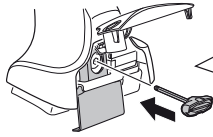

\*  
3 Nm



\*

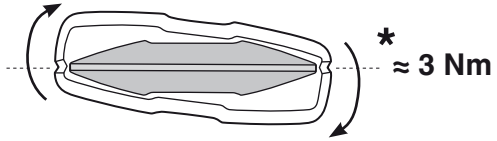

\*  
≈ 3 Nm

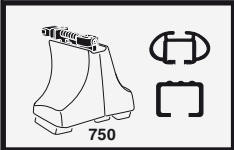
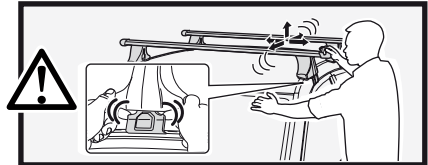

750

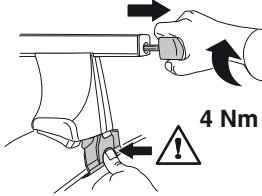

4 Nm

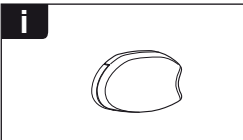
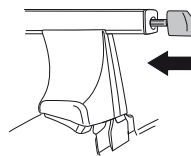

i

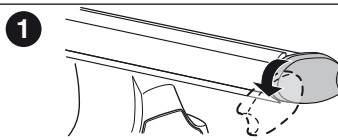

1

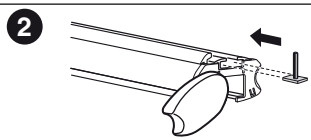

2

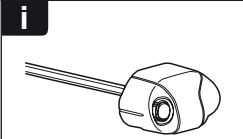

i

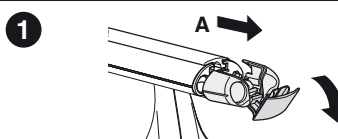

1

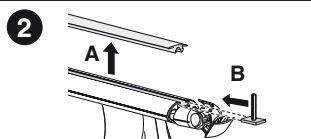

2

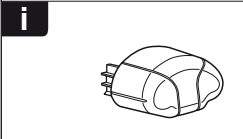

i

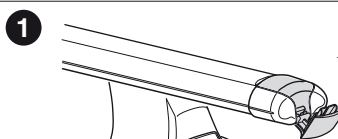

1

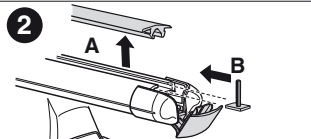

2



**THULE**  
SWEDEN  
**ONE  
KEY  
SYSTEM**



		544	(x4)
		596	(x6)
		588	(x8)
NA		510	(x10)
EUR		452	(x12)
ASIA			



WW ▶ Thule Sweden AB, Box 69, 330 33 Hillerstorp, SWEDEN  
NA ▶ Thule Inc., 42 Silvermine Road, Seymour, Connecticut 06483, USA

info@thule.com  
customer.service@thule.com

www.thule.com