

Kit 1239

MITSUBISHI Lancer, 4-dr Sedan, 00-03, 04-07 / *02-07

MITSUBISHI Lancer, 5-dr Estate, 00-03, 04-07

MITSUBISHI Lancer Sportback, 5-dr Wagon, *04-05

MITSUBISHI Lancer Cedia, 4-dr Sedan, 01-03

MITSUBISHI Lancer EVO VII, 4-dr Sedan, 01-03

MITSUBISHI Lancer EVO, 4-dr Sedan, *02-07

*North America

480R
754

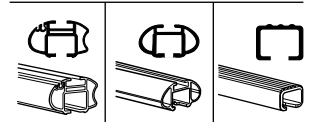
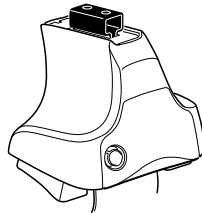

480

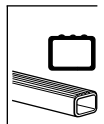
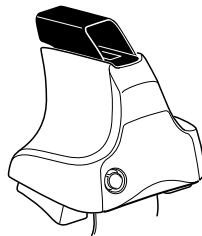

750

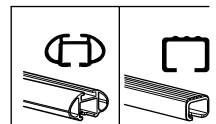
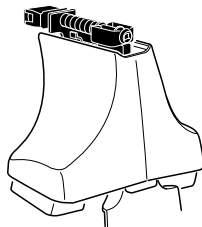

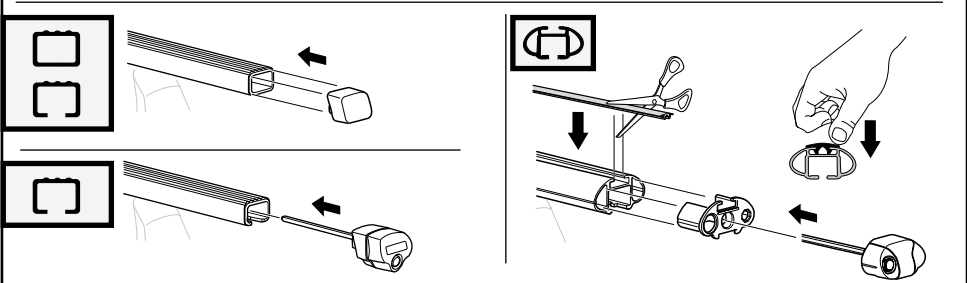
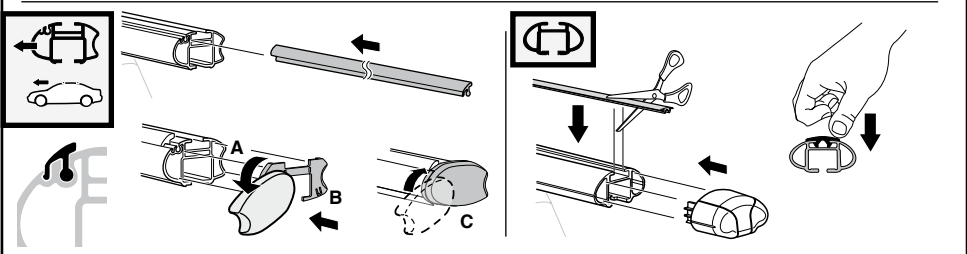
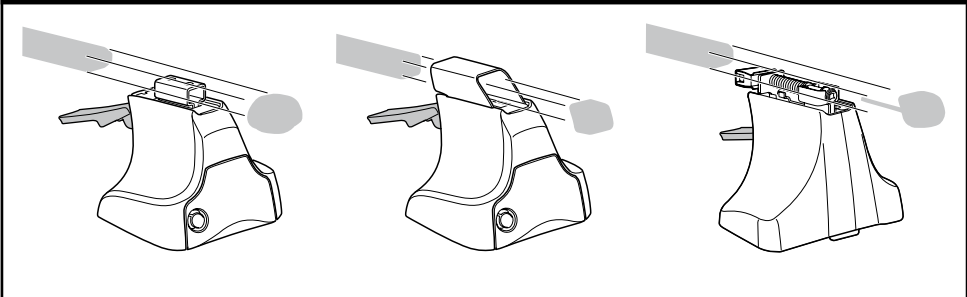

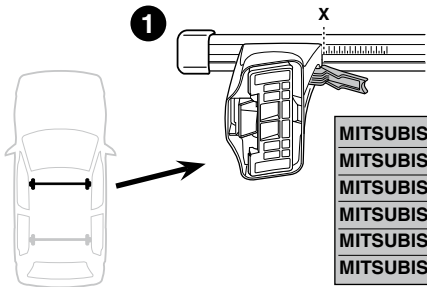
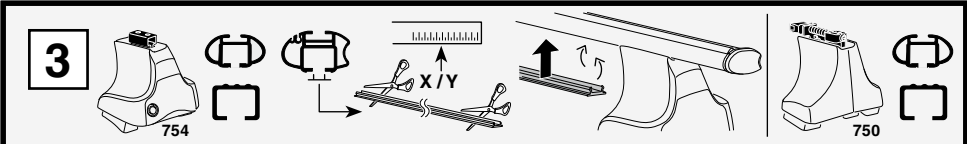

	X
754 MITSUBISHI Lancer, 4-dr Sedan, 00-03, 04-07 / *02-07	35,5
MITSUBISHI Lancer, 5-dr Estate, 00-03, 04-07	35,5
MITSUBISHI Lancer Sportback, 5-dr Wagon, *04-05	35,5
MITSUBISHI Lancer Cedia, 4-dr Sedan, 01-03	36,5
MITSUBISHI Lancer EVO VII, 4-dr Sedan, 01-03	36,5
MITSUBISHI Lancer EVO, 4-dr Sedan, *02-07	36,5

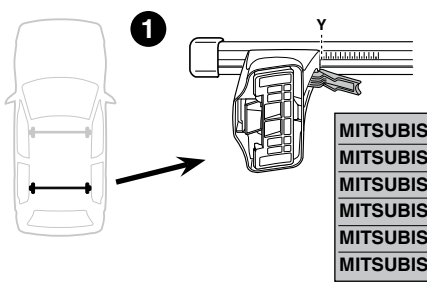

	Y
750 MITSUBISHI Lancer, 4-dr Sedan, 00-03, 04-07 / *02-07	30,5
MITSUBISHI Lancer, 5-dr Estate, 00-03, 04-07	32
MITSUBISHI Lancer Sportback, 5-dr Wagon, *04-05	32
MITSUBISHI Lancer Cedia, 4-dr Sedan, 01-03	31
MITSUBISHI Lancer EVO VII, 4-dr Sedan, 01-03	31
MITSUBISHI Lancer EVO, 4-dr Sedan, *02-07	31

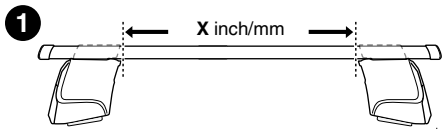
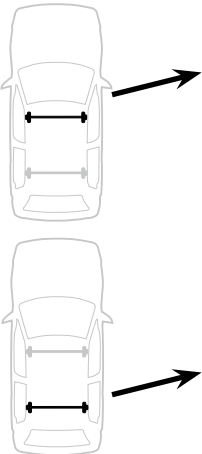
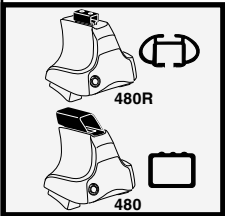

	X inch	X mm
480R MITSUBISHI Lancer, 4-dr Sedan, 00-03, 04-07 / *02-07	39 ⁵ / ₈ "	1006 mm
MITSUBISHI Lancer, 5-dr Estate, 00-03, 04-07	39 ⁵ / ₈ "	1006 mm
MITSUBISHI Lancer Sportback, 5-dr Wagon, *04-05	39 ⁵ / ₈ "	1006 mm
MITSUBISHI Lancer Cedia, 4-dr Sedan, 01-03	40 "	1016 mm
MITSUBISHI Lancer EVO VII, 4-dr Sedan, 01-03	40 "	1016 mm
MITSUBISHI Lancer EVO, 4-dr Sedan, *02-07	40 "	1016 mm

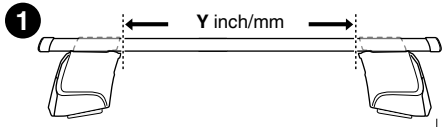

	Y inch	Y mm
480 MITSUBISHI Lancer, 4-dr Sedan, 00-03, 04-07 / *02-07	37 ⁵ / ₈ "	956 mm
MITSUBISHI Lancer, 5-dr Estate, 00-03, 04-07	38 ¹ / ₄ "	971 mm
MITSUBISHI Lancer Sportback, 5-dr Wagon, *04-05	38 ¹ / ₄ "	971 mm
MITSUBISHI Lancer Cedia, 4-dr Sedan, 01-03	37 ⁷ / ₈ "	961 mm
MITSUBISHI Lancer EVO VII, 4-dr Sedan, 01-03	37 ⁷ / ₈ "	961 mm
MITSUBISHI Lancer EVO, 4-dr Sedan, *02-07	37 ⁷ / ₈ "	961 mm

4**MITSUBISHI Lancer**, 4-dr Sedan, 00-03, 04-07 / *02-07**MITSUBISHI Lancer**, 5-dr Estate, 00-03, 04-07**MITSUBISHI Lancer Sportback**, 5-dr Wagon, *04-05**MITSUBISHI Lancer Cedia**, 4-dr Sedan, 01-03**MITSUBISHI Lancer EVO VII**, 4-dr Sedan, 01-03**MITSUBISHI Lancer EVO**, 4-dr Sedan, *02-07

52



420

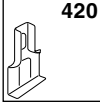

FL ↓



52



420

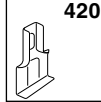

↓ FR



52



419

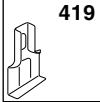

↓ RL



52



419

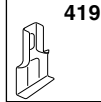

RR ↓

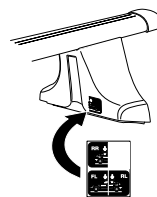
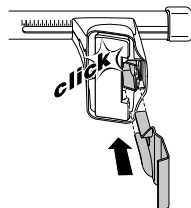
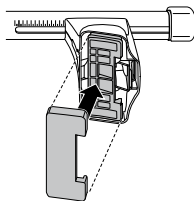
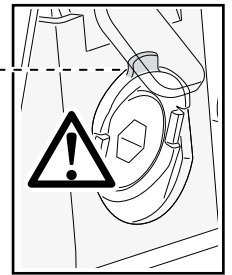
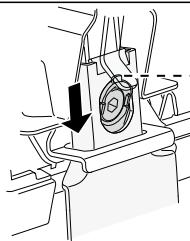
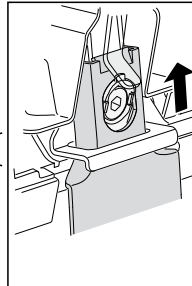
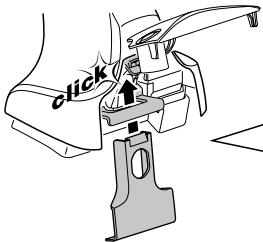
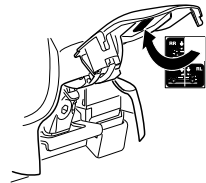
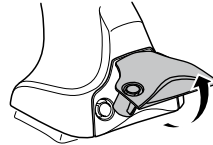
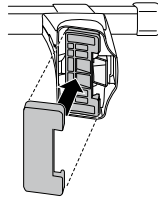
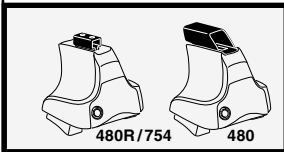

5

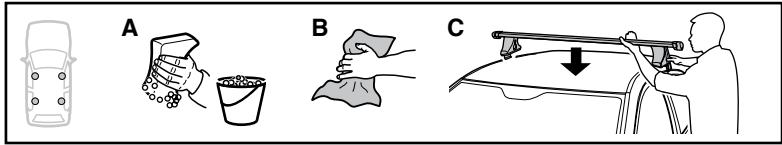

	X mm	Y mm	X inch	Y inch
MITSUBISHI Lancer , 4-dr Sedan, 00-03, 04-07 / *02-07	255 mm	650 mm	10"	25 5/8"
MITSUBISHI Lancer , 5-dr Estate, 00-03, 04-07	300 mm	750 mm	11 3/4"	29 1/2"
MITSUBISHI Lancer Sportback , 5-dr Wagon, *04-05	300 mm	750 mm	11 3/4"	29 1/2"
MITSUBISHI Lancer Cedia , 4-dr Sedan, 01-03	255 mm	650 mm	10"	25 5/8"
MITSUBISHI Lancer EVO VII , 4-dr Sedan, 01-03	255 mm	650 mm	10"	25 5/8"
MITSUBISHI Lancer EVO , 4-dr Sedan, *02-07	255 mm	650 mm	10"	25 5/8"

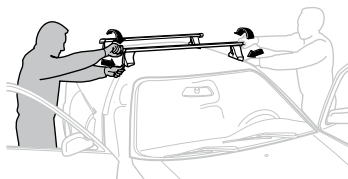
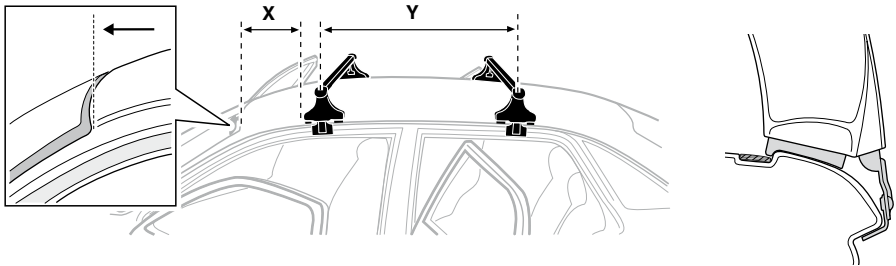

GB/US Tighten alternately

D Die Schrauben abwechselnd anziehen

F Serrer alternativement chaque côté

NL Afwisselend aan de linker- en de rechterkant aandraaien

I Alternare il serraggio delle viti

E Serrare alternativamente

PT Aperte alternadamente

S Dra åt växelvis

FIN Kierrä vuorotellen

EST Pinguldage vaheldumisi

LAT Pievelciet pamišus

LIT Užsukinėkite pakaitomis

PL Śruby dokręcaj naprzemiennie

RU Затягивайте попеременно

CZ Pokręťta bagażníka dokręcaj dokręcaj naprzemiennie.

SK Doťahujte striedavo

SLO Privijajte izmenično.

HR Naizmjenično zategnite

HU Egymástól függetlenül szorítandó

GR Σφιγγετε εναλλάξ

TR Dönüşümlü sıkın

中文 交替拧紧

한국어 번갈아 가며 조이십시오.

日本語 交互に締め付けてください。

ไทย ชันโนแบบสลับ

6

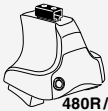

480R/754



480

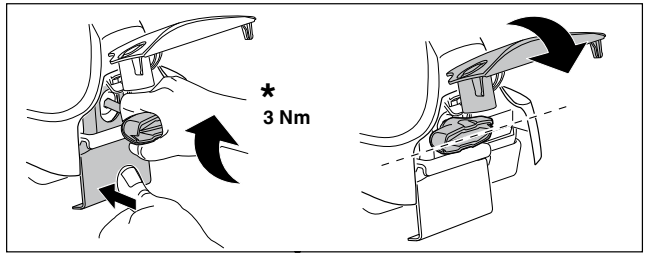
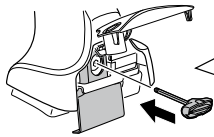

*
3 Nm

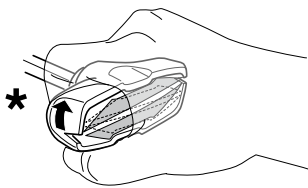

*

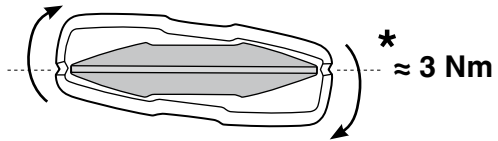

*
≈ 3 Nm

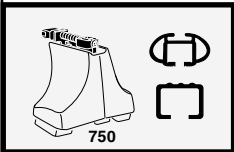
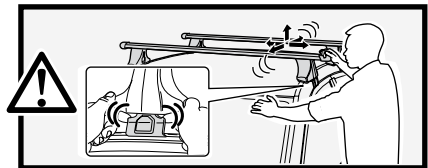

750

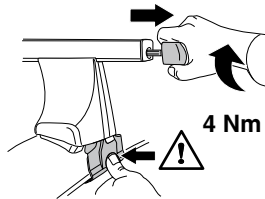

4 Nm

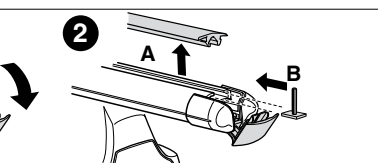
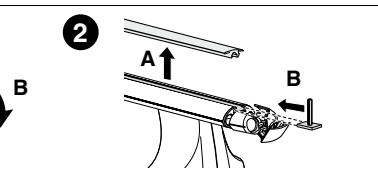
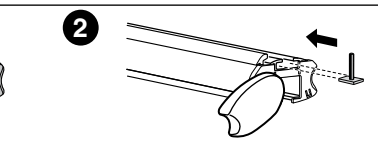
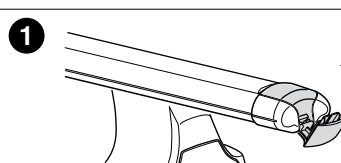
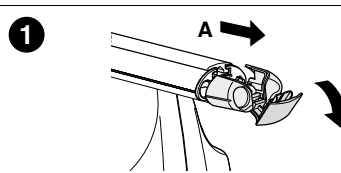
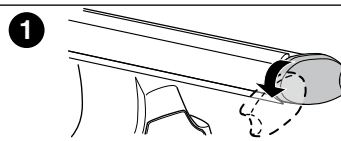
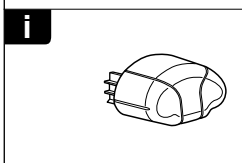
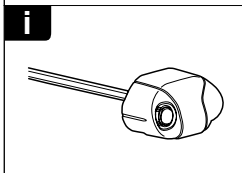
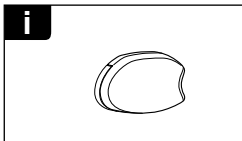
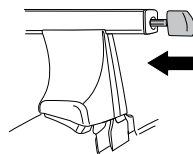

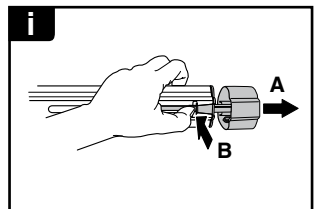
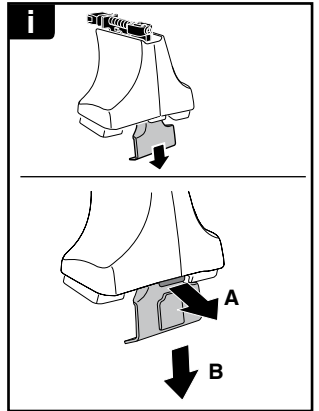
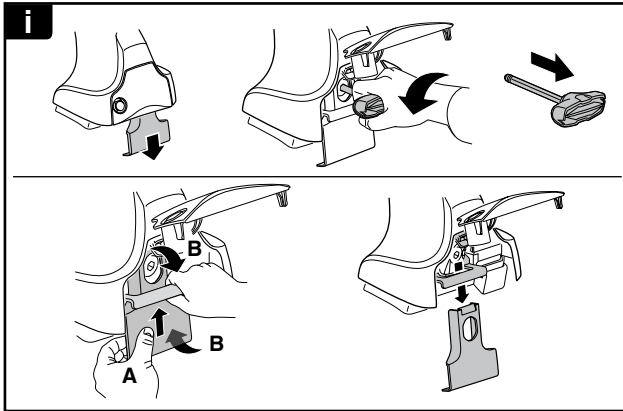
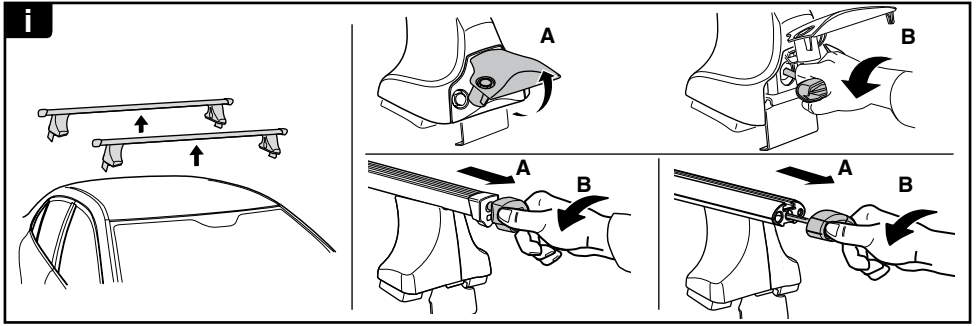

THULE
SWEDEN
**ONE
KEY
SYSTEM**

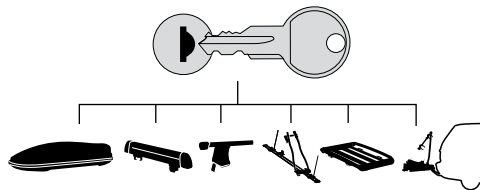

- 544 (x4)
- 596 (x6)
- 588 (x8)
- NA 510 (x10)
- EUR 452 (x12)
- ASIA

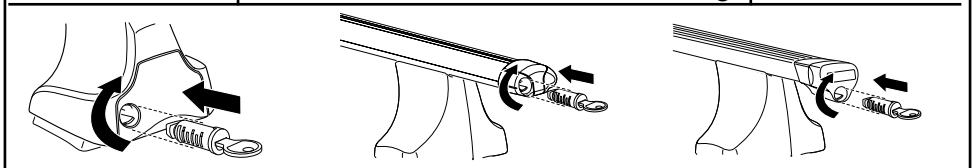

WW ▶ Thule Sweden AB, Box 69, 330 33 Hillerstorp, SWEDEN
 NA ▶ Thule Inc., 42 Silvermine Road, Seymour, Connecticut 06483, USA

info@thule.com
 customer.service@thule.com

www.thule.com