

Kit 3035

CITROËN C8, 5-dr MPV, 02-10

CITROËN Evasion, 5-dr MPV, 94-01

FIAT Ulyssé, 5-dr MPV, 94-01, 02-10

LANCIA Phedra, 5-dr MPV, 02-10

LANCIA Zeta, 5-dr MPV, 94-01

PEUGEOT 806, 5-dr MPV, 94-01

PEUGEOT 807, 5-dr MPV, 02-10

This Kit is only for vehicles with T-profile.

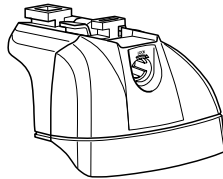

460R
753

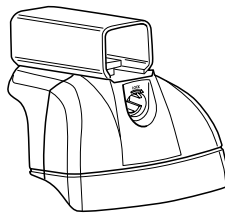
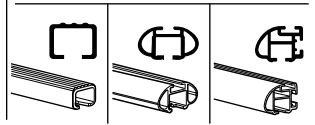

460

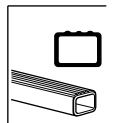

THULE[®]
SWEDEN

ISO 11154-E

6 kg / 13 lbs + xx kg xx lbs =

Max. 100 kg
Max. 220 lbs

9 kg / 20 lbs + xx kg xx lbs =

Max. 150 kg
Max. 330 lbs

12 kg / 26 lbs + xx kg xx lbs =

Max. 200 kg
Max. 440 lbs

THULE Kit XXXX

instructions

THULE

80 km/h 130 km/h
50 Mph 80 Mph

40 km/h 25 Mph

0 km/h Mph

A B C

09 x 4

34 x 4

RR FR
FL RL x 1

31307 x 8

30147 x 8

50094 x 4

30065 x 1

Kit



753



x4



x4



x4



x8



x1



x4



x1

460R

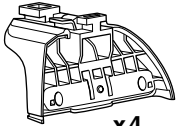

x4



x4



x4



x8



x1



x4

460

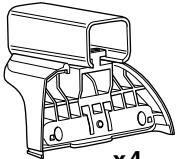

x4



x4



x4



x8



x1



x4



x2



x2



x2



x2



x2



x2



17 mm

x2

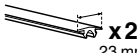

23 mm

x2

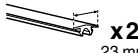

23 mm

x2

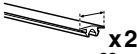

23 mm

x2

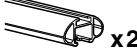

x2

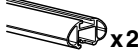

x2



x2



x4



x4



x4



17 mm

x2



25 mm

x2



x2

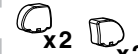

x2

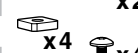

x2



x4

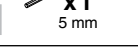

x4



x1

5 mm

1

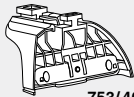

753/460R

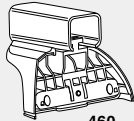

460

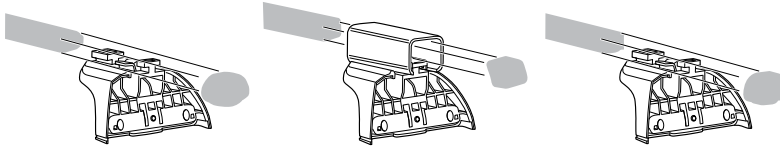

x4

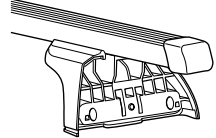
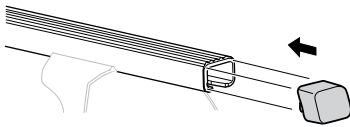

x4

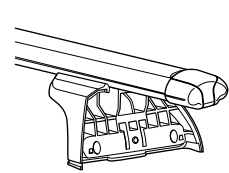
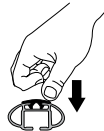
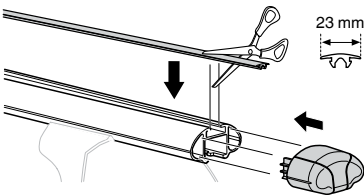

x4

x4

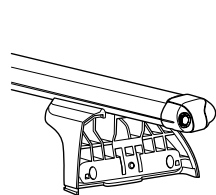
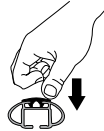
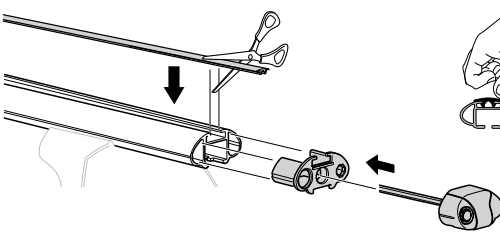

x4

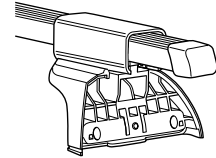
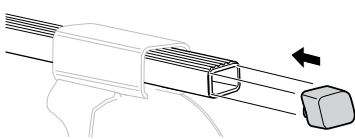

x2

x2

x4

x4

x1
5 mm

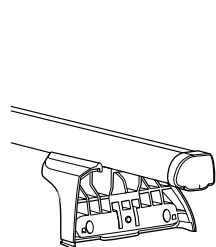
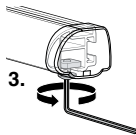
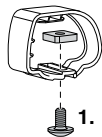
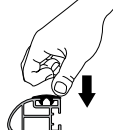
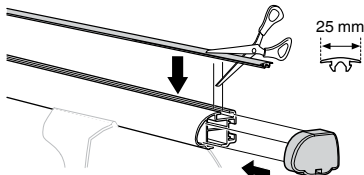

2

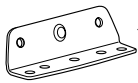

◀ 09 x 4



◀ 34 x 4

16 mm  x 8



x 1

09



34



09



34



09



34



09



34

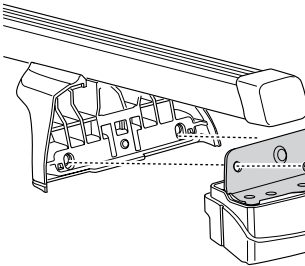
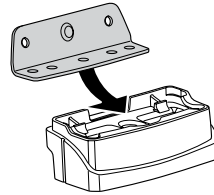
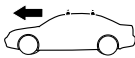

i

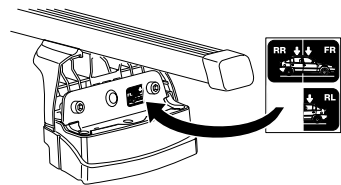

i

- GB** Only a few turns
- D** Nur wenige Umdrehungen
- F** Quelques tours uniquement
- NL** Slechts enkele slagen
- I** Solo qualche giro
- E** Sólo algunas vueltas
- PT** Noções básicas
- S** Endast några varv
- FIN** Vain muutama kierros

- EST** Ainult mõni pööre
- LAT** Tikai dažī apgriezieni
- LIT** Tik keli pasukimai
- PL** Wystarczy kilka obrotów
- RU** Достаточно нескольких оборотов
- CZ** Pouze několik otáčec
- SK** Len niekoľko otáčok
- SLO** Le nekaj obratov

- HR** Samo nekoliko okreta
- HU** Csak néhány fordítás
- GR** Μόνο μερικές στροφές
- TR** Yalnız birkaç kez çevirm
- 中文** 只有几个转向
- 한국어** 두 세번만
- 日本語** 数回転のみ
- ไทย** หมุนเพียงไม่กี่รอบ

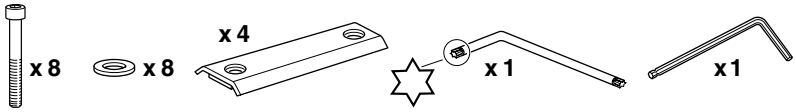
3

CITROËN C8, 5-dr MPV, 02-10
CITROËN Evasion, 5-dr MPV, 94-01
FIAT Ulyssé, 5-dr MPV, 94-01, 02-10
LANCIA Phedra, 5-dr MPV, 02-10
LANCIA Zeta, 5-dr MPV, 94-01
PEUGEOT 807, 5-dr MPV, 02-10

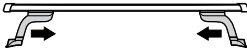
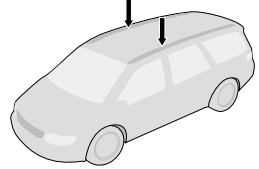
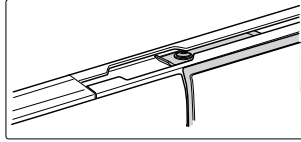
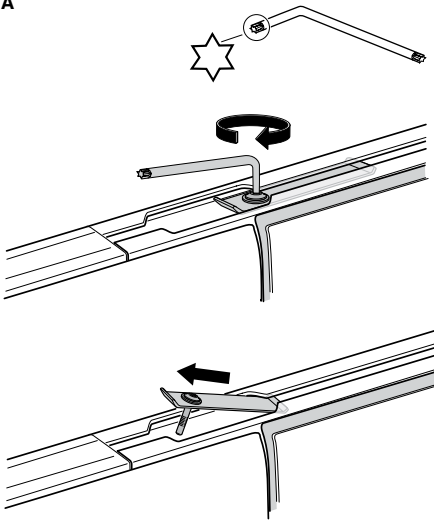
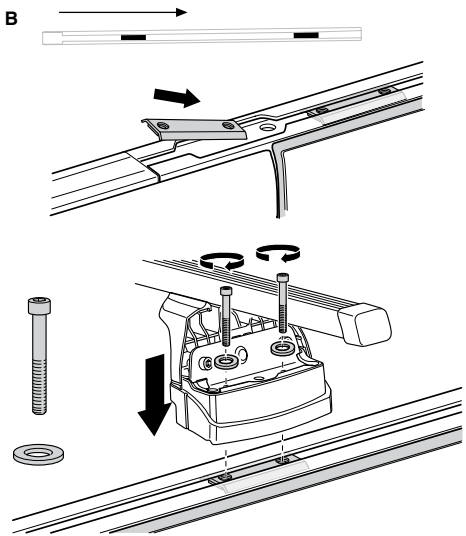
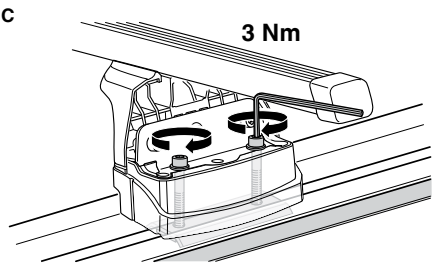
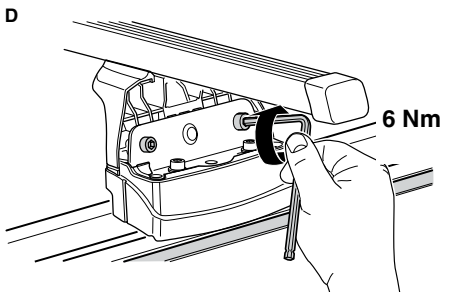
**A****B****C****D**

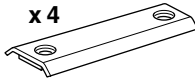
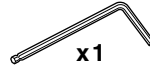
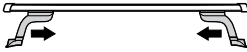
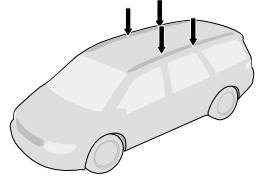
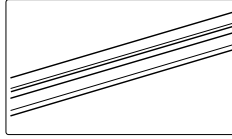
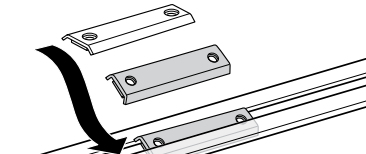
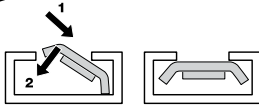
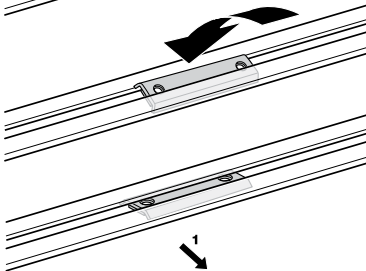
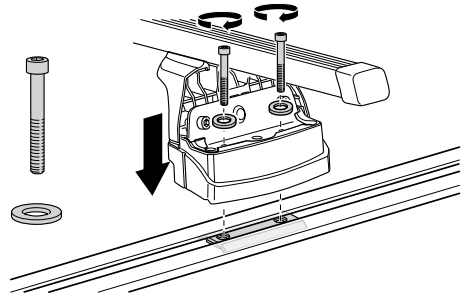
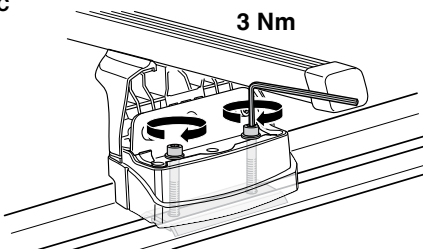
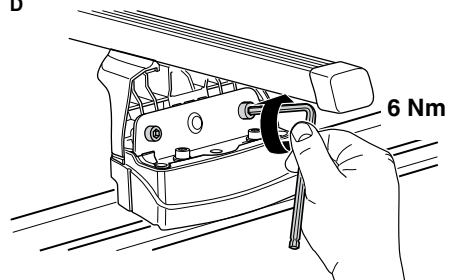
3**x 8****x 8****x 4****x 1****PEUGEOT 806**, 5-dr MPV, 94-01**A 1****2****B****C****3 Nm****D****6 Nm**

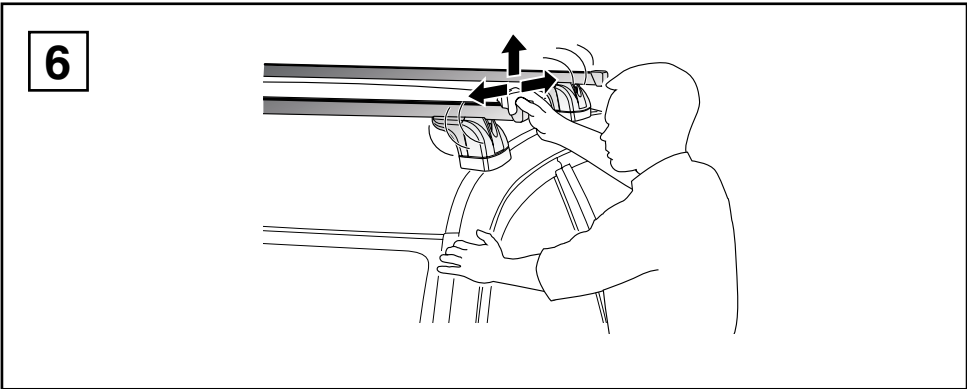
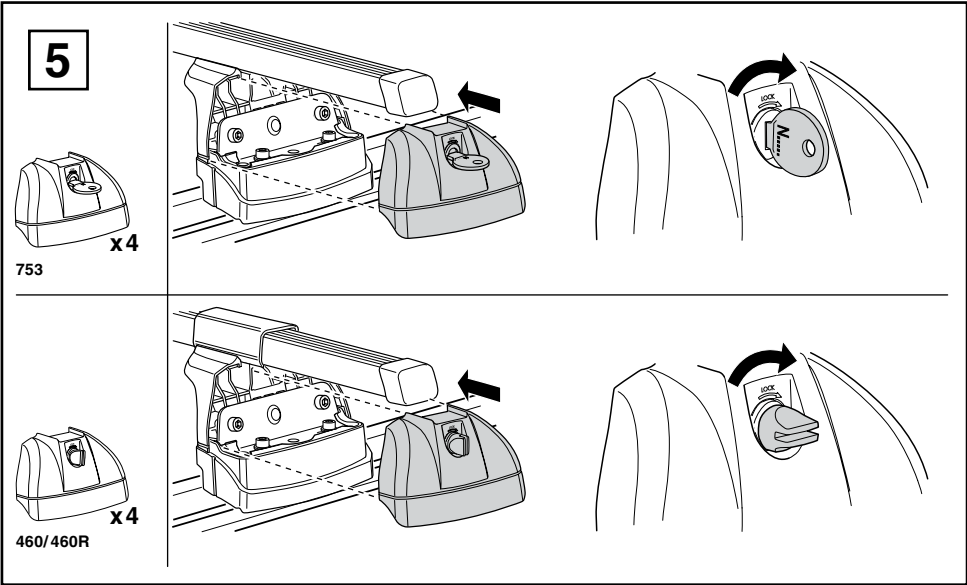
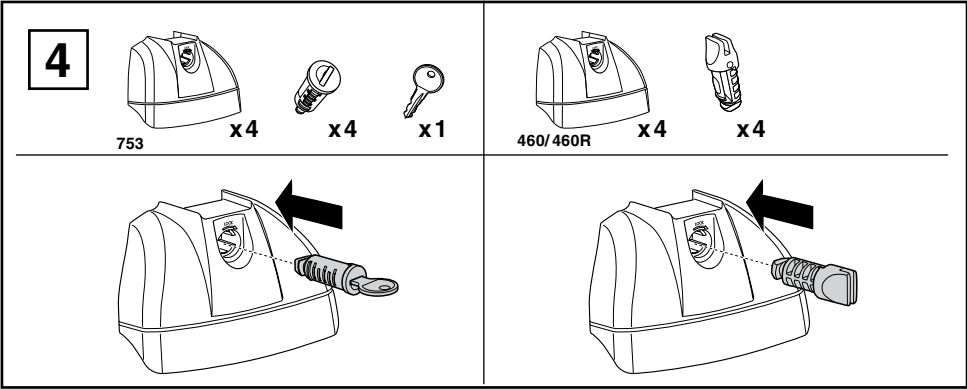

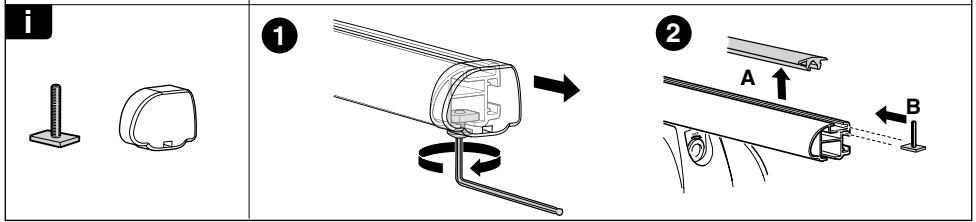
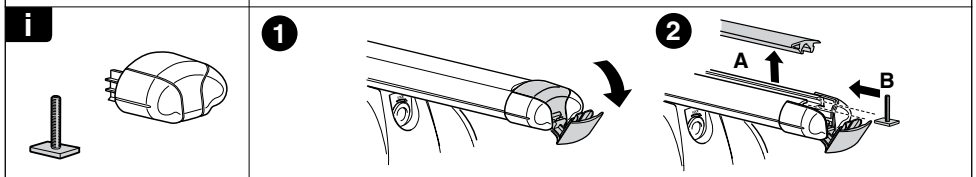
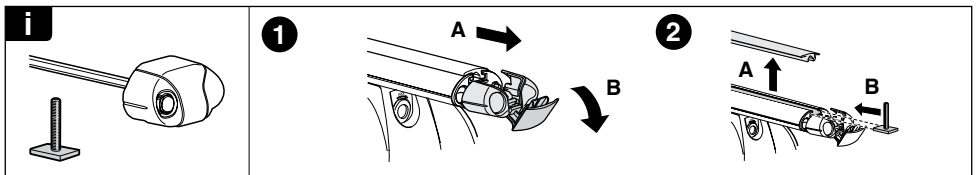
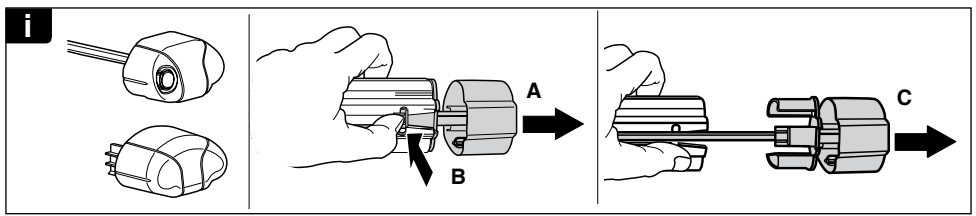
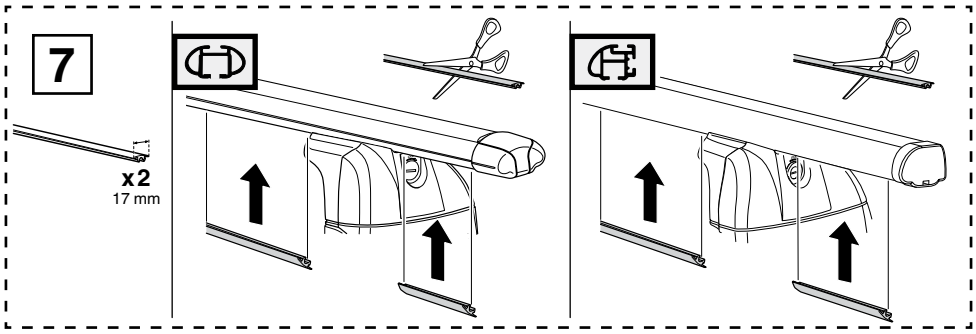

THULE
SWEDEN

**ONE
KEY
SYSTEM**

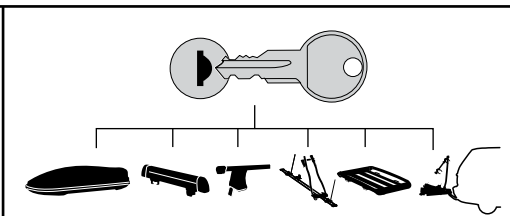

- 544** (x4)
- 596** (x6)
- 588** (x8)
- 510** (x10)
- EUR 452** (x12)
- ASIA**