

# Kit 3070

- CITROËN Nemo**, 3-dr Van, 08–
- CITROËN Nemo**, 4-dr Van, 08–
- CITROËN Nemo**, 5-dr Van, 08–
- FIAT Fiorino**, 3-dr Van, 08–
- FIAT Fiorino**, 4-dr Van, 08–
- FIAT Fiorino**, 5-dr Van, 08–
- FIAT Qubo**, 4-dr MPV, 08–
- FIAT Qubo**, 5-dr MPV, 08–
- PEUGEOT Bipper**, 3-dr Van, 08–
- PEUGEOT Bipper**, 4-dr Van, 08–
- PEUGEOT Bipper**, 5-dr Van, 08–

This Kit is only for vehicles with fixpoint mounting.

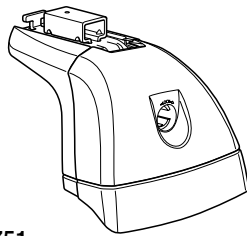

751

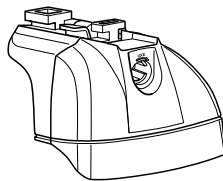
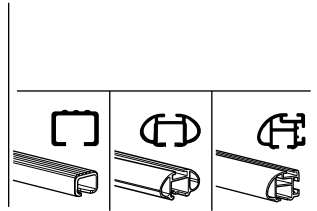

753

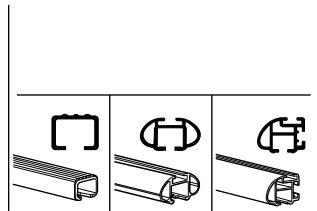

6 kg / 13 lbs + xx kg / xx lbs = Max. 100 kg / Max. 220 lbs

9 kg / 20 lbs + xx kg / xx lbs = Max. 150 kg / Max. 330 lbs

THULE + Kit XXXX + instructions

40 km/h 25 Mph, 80 km/h 50 Mph, 130 km/h 80 Mph

A B C

09 x 4, 107 x 1, 106 x 2, 108 x 1, 50985 50 mm x 4, x 4, x 1

**Kit**

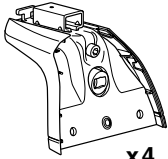
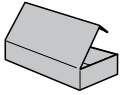

751

x4



x4



x4



12 mm

x8



5 mm

x1



x4



x1

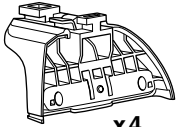

753

x4



x4



x4



16 mm

x8



5 mm

x1



x4



x1

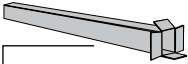

x2



x2

17 mm



x2

23 mm



x2

23 mm



x2

17 mm



x2

23 mm



x2



x2



x2

25 mm



x2



x4



x4



x4



x2

x2



x4

x4



x1

5 mm

1

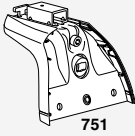

751

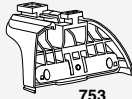

753

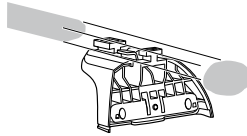
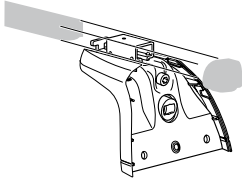

x4

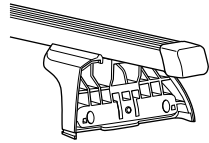
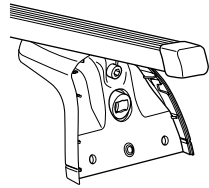
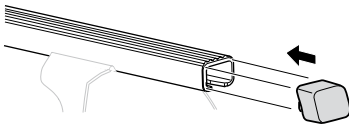

x4

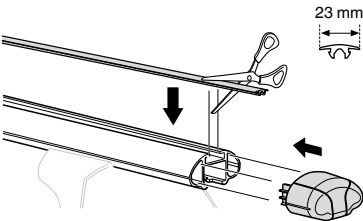

23 mm

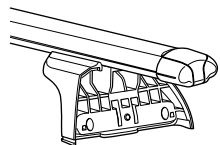
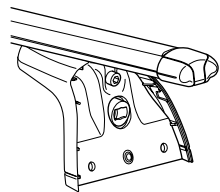
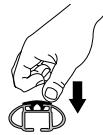



 x4

 x4

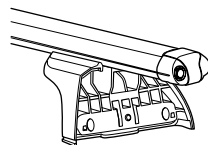
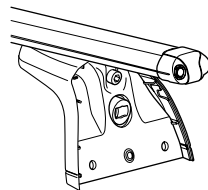
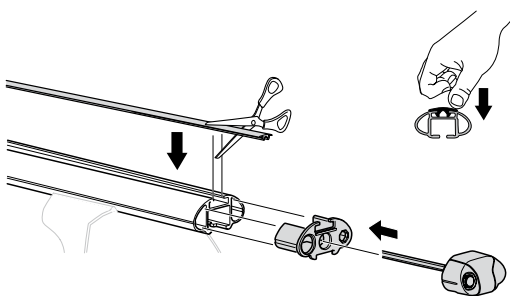

 x2

 x2

 x4

 x4

 x1  
5 mm

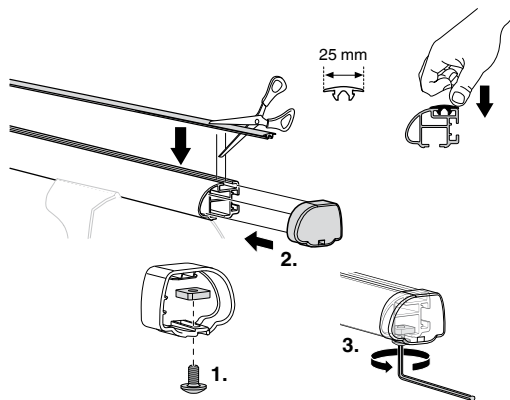

25 mm

2.

3.

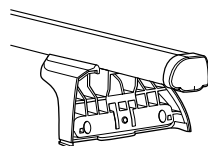
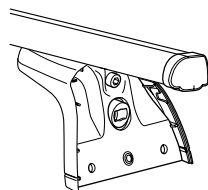

2

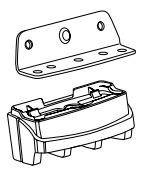

09 x 4



107 x 1

12 mm  
x 8

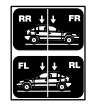

x 1

106 x 2

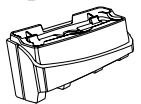

108 x 1

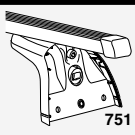

751

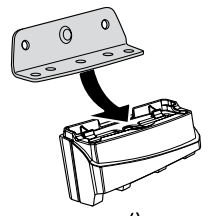
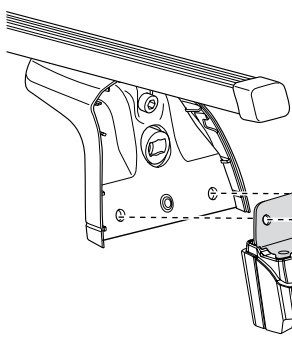
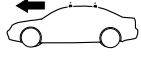
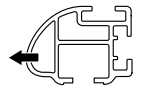
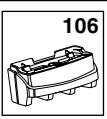
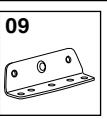
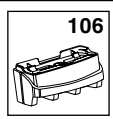
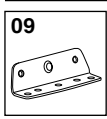
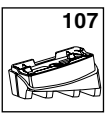
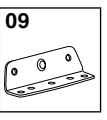
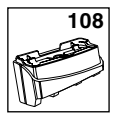
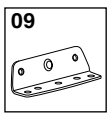
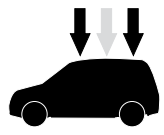

**i**

**i**

- GB** Only a few turns
- D** Nur wenige Umdrehungen
- F** Quelques tours uniquement
- NL** Slechts enkele slagen
- I** Solo qualche giro
- E** Sólo algunas vueltas
- PT** Noções básicas
- S** Endast några varv
- FIN** Vain muutama kierros
- EST** Ainult mõni pööre
- LAT** Tikai daži apgriezieni
- LIT** Tik keli pasukimai
- PL** Wystarczy kilka obrotów
- RU** Достаточно нескольких оборотов
- CZ** Pouze několik otáček
- SK** Len niekoľko otáčok
- SLO** Le nekaj obratov

- HR** Samo nekoliko okreta
- HU** Csak néhány fordítás
- GR** Μόνο μερικές στροφές
- TR** Yalnız birkaç kez çevirm
- 中文** 只有几个转向
- 한국어** 두 세번만
- 日本語** 数回転のみ
- ไทย** หมุนเพียงไม่กี่รอบ

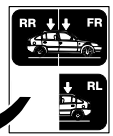
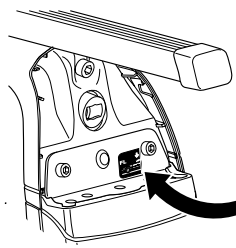

2

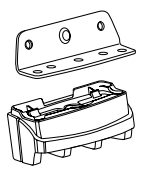

09 x 4



107 x 1



108 x 1

16 mm x 8

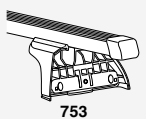

753

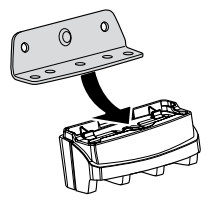
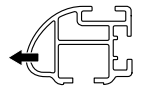
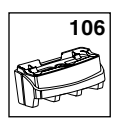
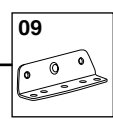
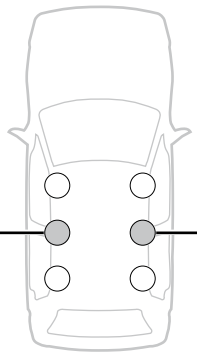
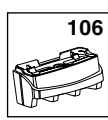
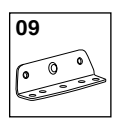
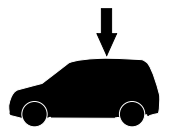

**i**

- GB** Only a few turns
- D** Nur wenige Umdrehungen
- F** Quelques tours uniquement
- NL** Slechts enkele slagen
- I** Solo qualche giro
- E** Sólo algunas vueltas
- PT** Noções básicas
- S** Endast några varv
- FIN** Vain muutama kierros
- EST** Ainult mõni pööre
- LAT** Tikai daži apgriezieni
- LIT** Tik keli pasukimai
- PL** Wystarczy kilka obrotów
- RU** Достаточно нескольких оборотов
- CZ** Pouze několik otáček
- SK** Len niekoľko otáčok
- SLO** Le nekaj obratov

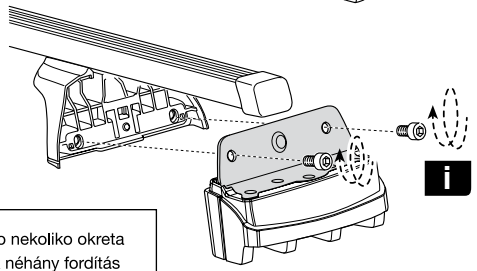

**i**

- HR** Samo nekoliko okreta
- HU** Csak néhány fordítás
- GR** Μόνο μερικές στροφές
- TR** Yalnız birkaç kez çevirm
- 中文** 只有几个转向
- 한국어** 두 세번만
- 日本語** 数回転のみ
- ไทย** หมุนเพียงไม่กี่รอบ

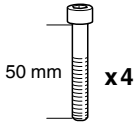
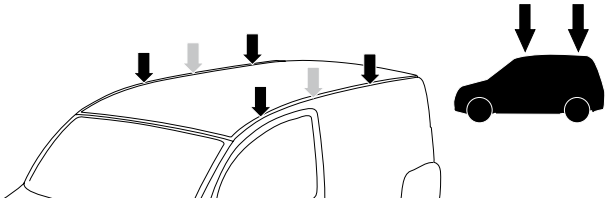
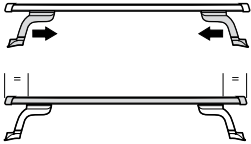
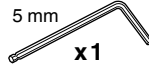
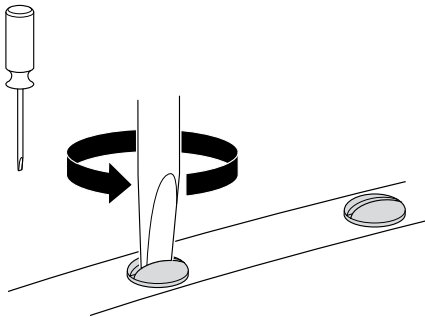
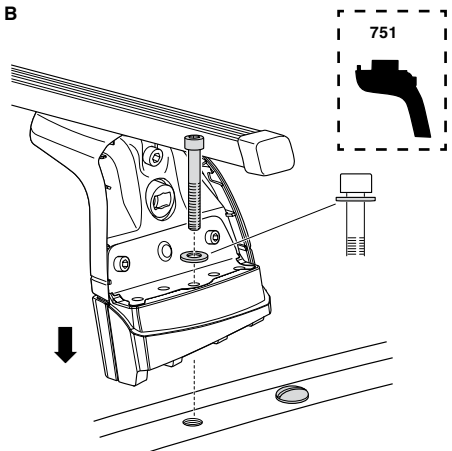
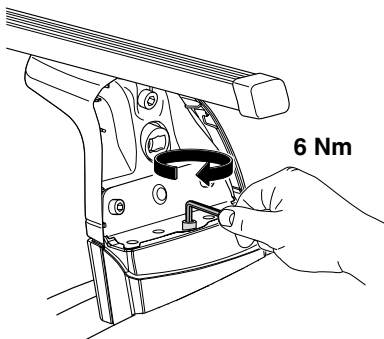
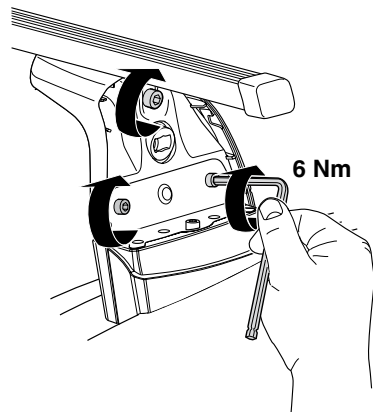
**3****x4****A****B****C****6 Nm****D****6 Nm**



**3**

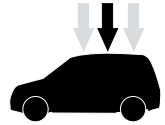
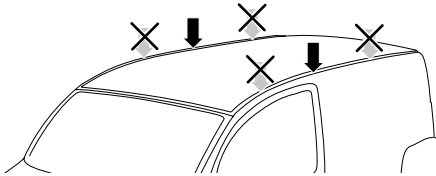
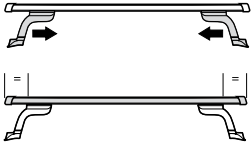
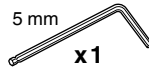
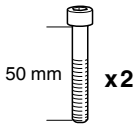

**A**

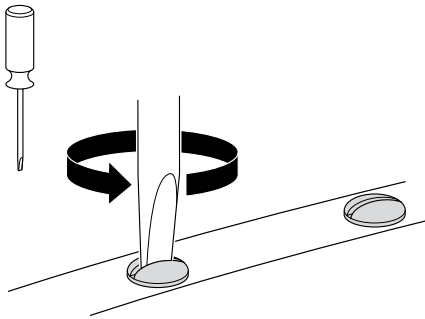

**B**

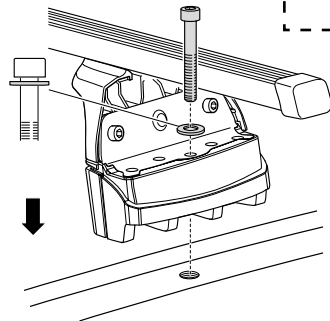

460R  
753  
460



**C**

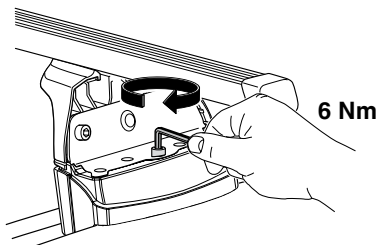

**D**

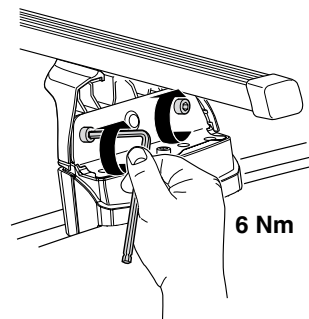

**4**



751

x4



x4



x1



753

x4



x4



x1

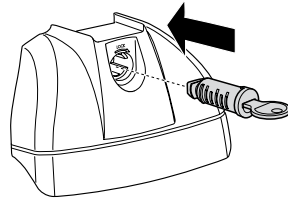
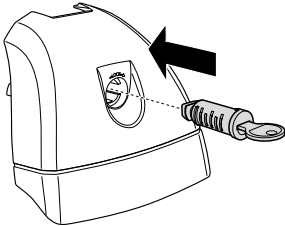

**5**

5 mm

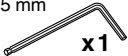

x1

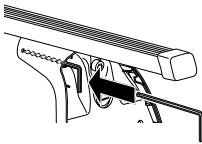

751

x4

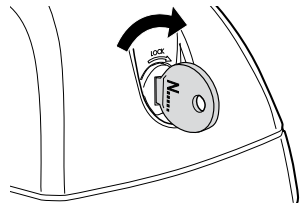
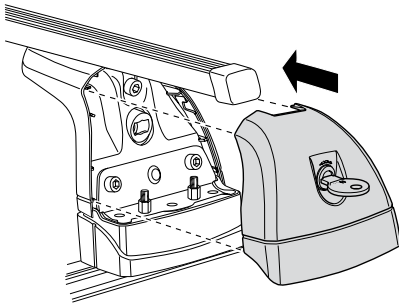

753

x4

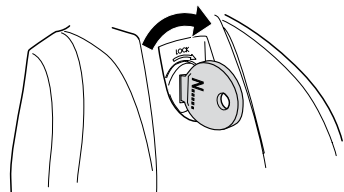
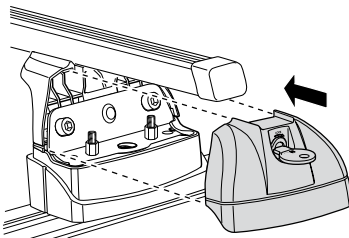

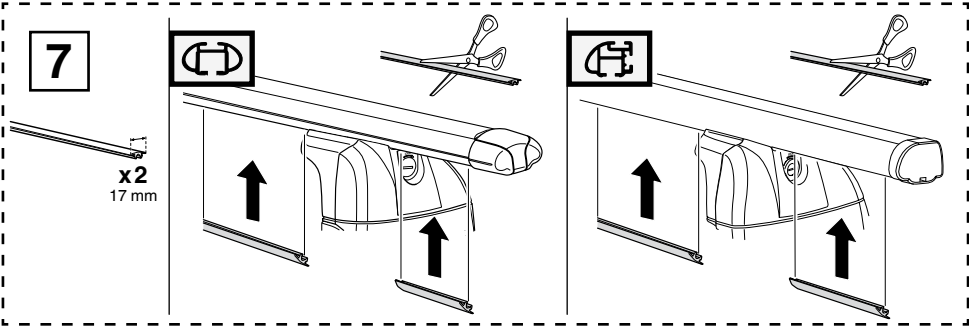
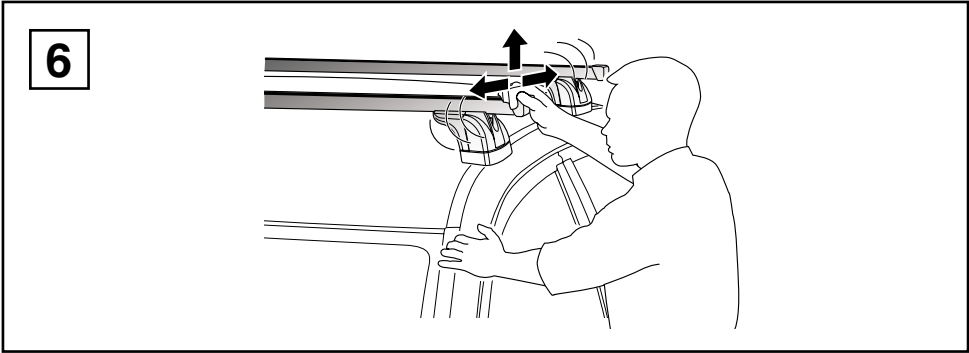

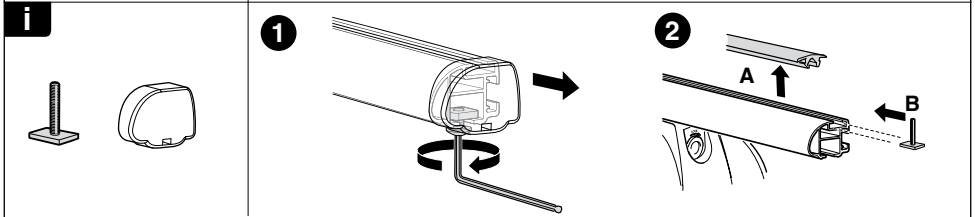
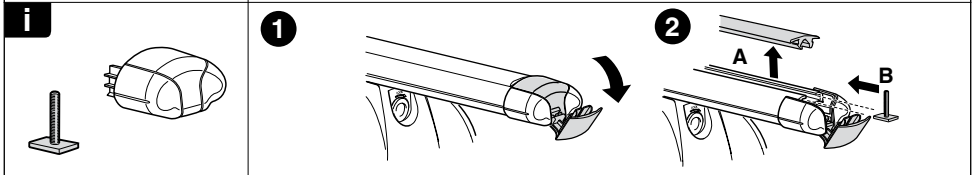
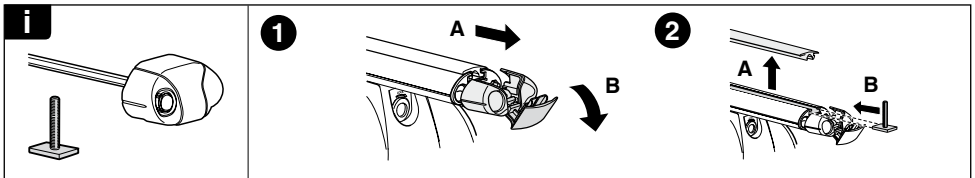
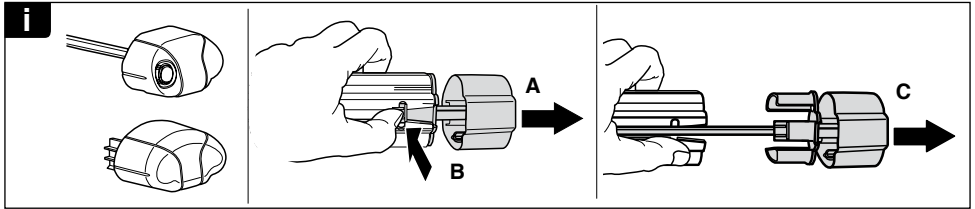
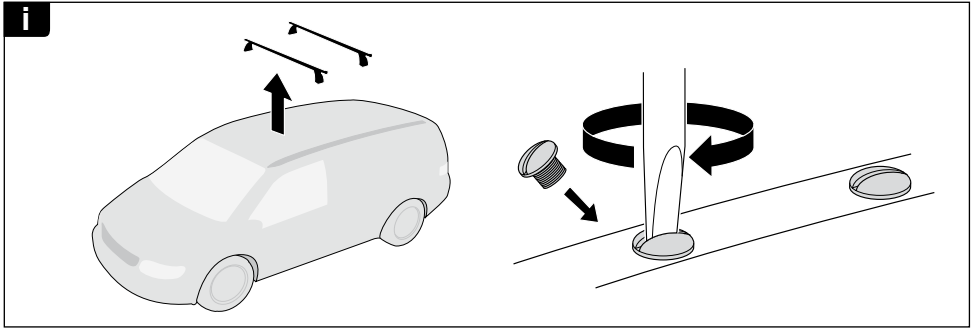

**THULE**  
SWEDEN  
**ONE  
KEY  
SYSTEM**

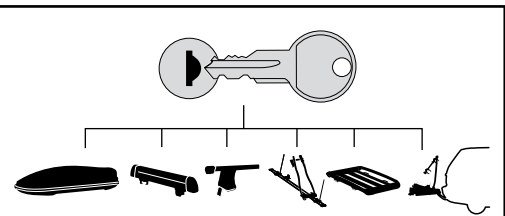

- 544** (x4)
- 596** (x6)
- 588** (x8)
- 510** (x10)
- 518** (x10)
- 452** (x12)

WW ▶ Thule Sweden AB, Box 69, 330 33 Hillerstorp, SWEDEN  
 NA ▶ Thule Inc., 42 Silvermine Road, Seymour, Connecticut 06483, USA

info@thule.com  
 customer.service@thule.com

www.thule.com  
 506-3070