

Kit 3124

OPEL Adam, 3-dr Hatchback, 13-
VAUXHALL Adam, 3-dr Hatchback, 13-

This Kit is only for vehicles with fixpoint mounting.

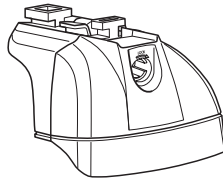

460R
753

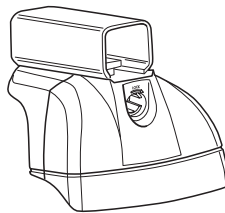

460

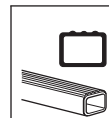

THULE[®]
SWEDEN

ISO 11154-E

- 07 x 1
- 12 x 1
- 08 x 1
- 13 x 1
- 07/13 x 1
- 08/15 x 1
- 07/14 x 1
- 08/16 x 1
- 50616 x 4
- 50751 x 4
- RR ↓ FR
- FL ↓ RL
- x 1

Kit

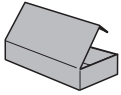

753

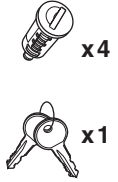
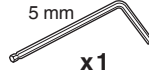
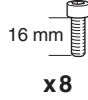
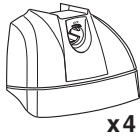
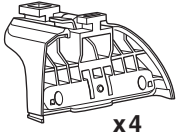

460R

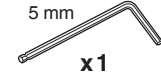
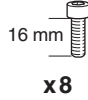
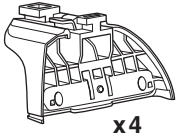

460

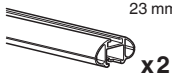
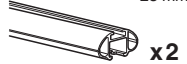
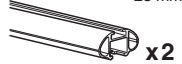
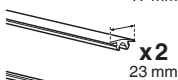
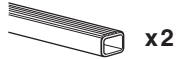
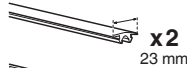
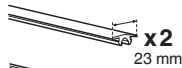
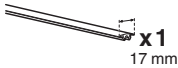
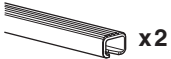
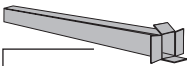
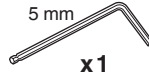
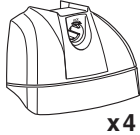
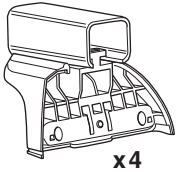

1

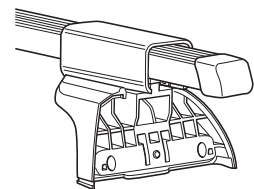
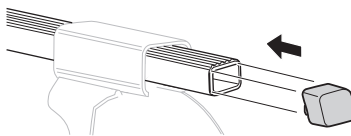
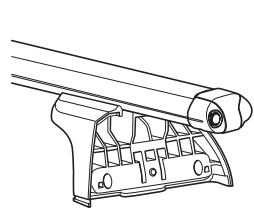
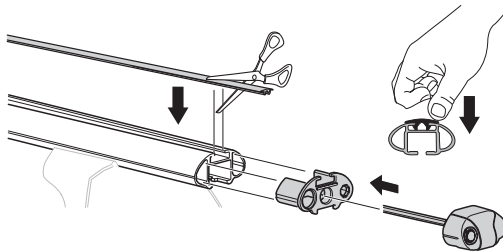
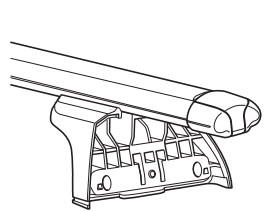
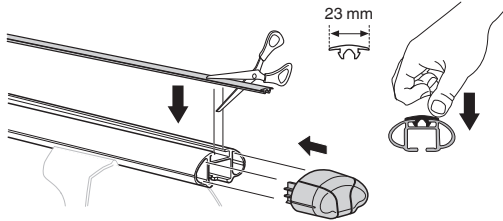
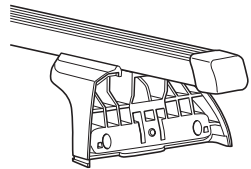
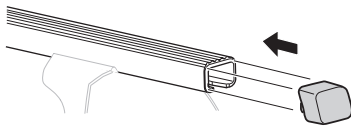
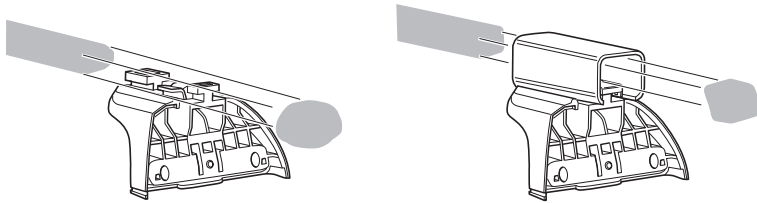
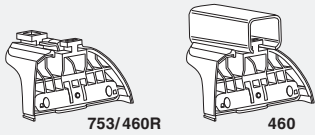

2

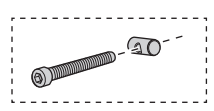
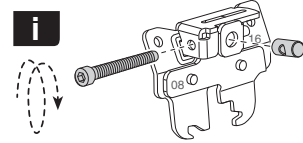
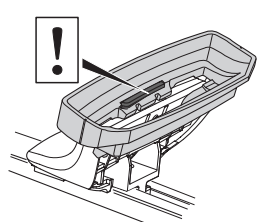
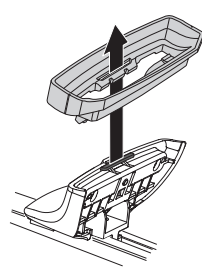
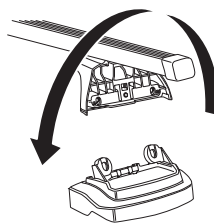
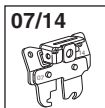
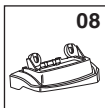
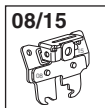
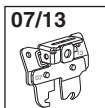
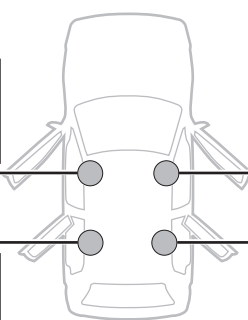
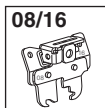
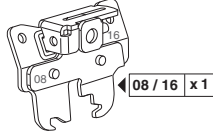
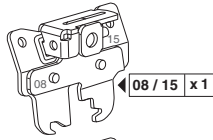
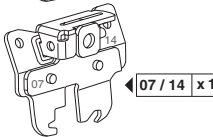
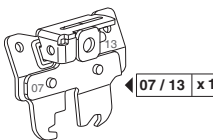
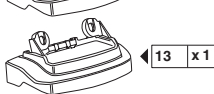

i	GB Only a few turns	EST Ainult mõni pööre	HR Samo nekoliko okreta
	D Nur wenige Umdrehungen	LAT Tikai dažī apgriezieni	HU Csak néhány fordítás
	F Quelques tours uniquement	LIT Tik keli pasukimai	GR Μόνο μερικές στροφές
	NL Slechts enkele slagen	PL Wystarczy kilka obrotów	TR Yalnız birkaç kez çevirm
	I Solo qualche giro	RU Достаточно нескольких оборотов	中文 只有几个转向
	E Sólo algunas vueltas	CZ Pouze několik otáček	한국어 두 세번만
	PT Noções básicas	SK Len niekoľko otáčok	日本語 数回転のみ
	S Endast några varv	SLO Le nekaj obratov	ไทย หมุนเพียงไม่กี่รอบ
	FIN Vain muutama kierros		

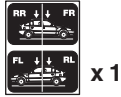
316 mm  x 8

x 1

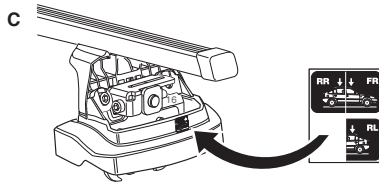
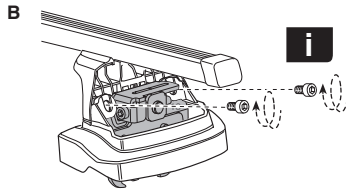
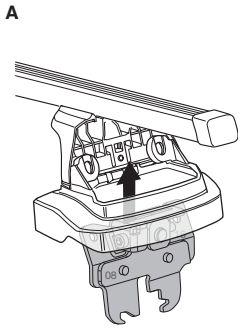
**i**

GB Only a few turns
D Nur wenige Umdrehungen
F Quelques tours uniquement
NL Slechts enkele slagen
I Solo qualche giro
E Sólo algumas vueltas
PT Noções básicas
S Endast några varv
FIN Vain muutama kierros
EST Ainult mõni pööre
LAT Tikai dažī apgriezieni
LIT Tik keli pasukimai
PL Wystarczy kilka obrotów
RU Достаточно нескольких оборотов
CZ Pouze několik otáček
SK Len niekoľko otáčok
SLO Le nekaj obratov
HR Samo nekoliko okreta
HU Csak néhány fordítás
GR Μόνο μερικές στροφές
TR Yalnız birkaç kez çevirm
中文 只有几个转向
한국어 두 세번만
日本語 数回転のみ
ไทย หมุนเพียงไม่กี่รอบ

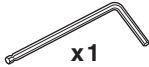
4

x 1

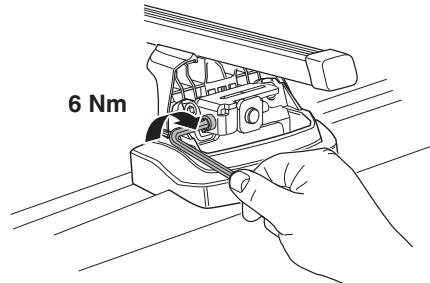
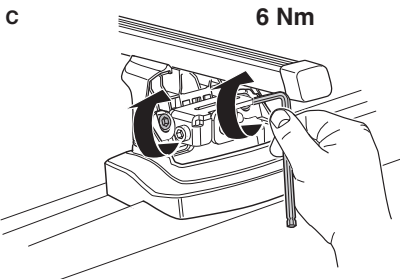
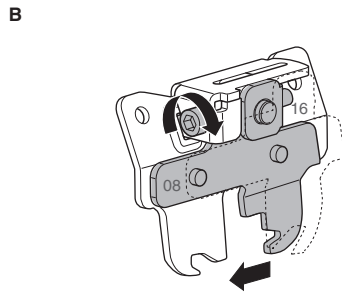
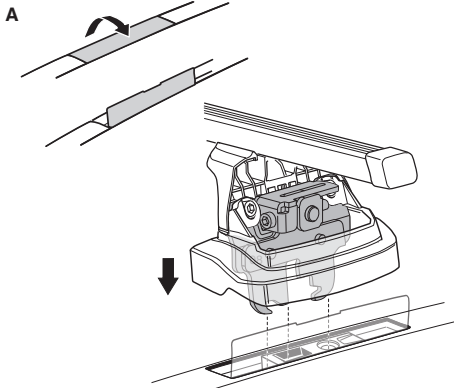
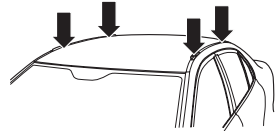
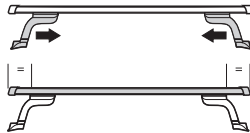

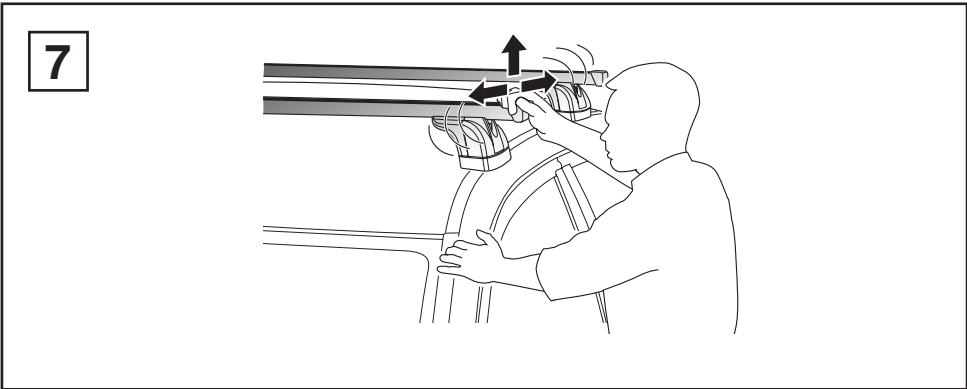
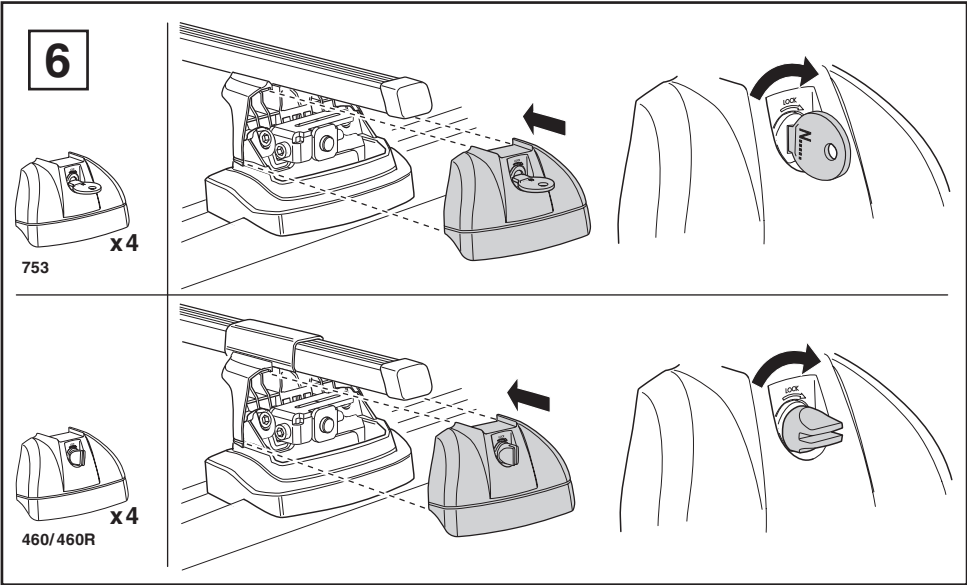
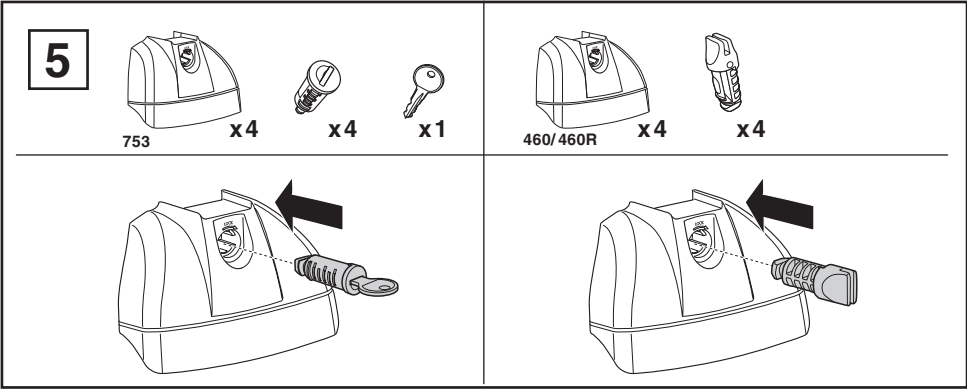

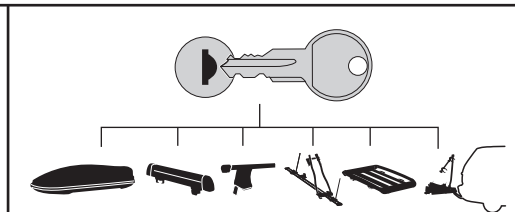
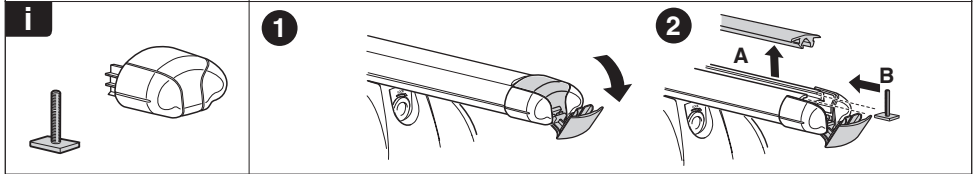
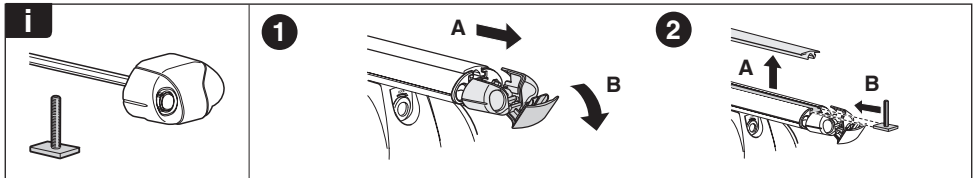
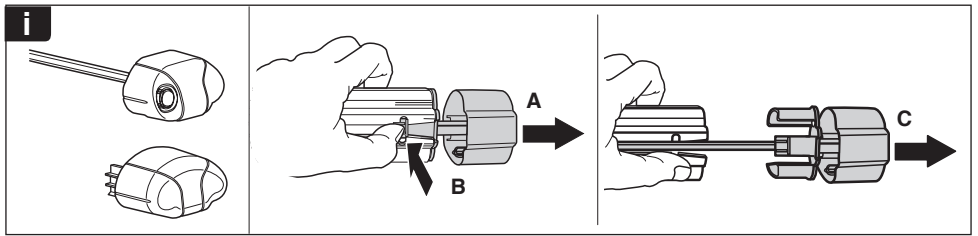
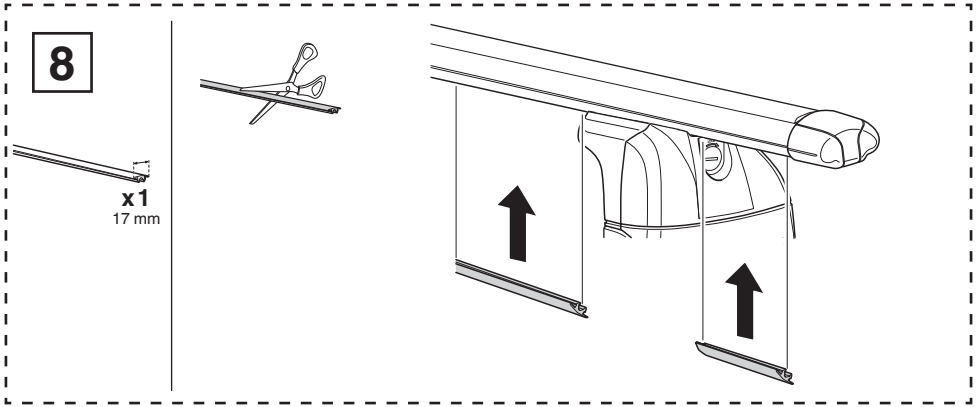

- 544 (x4)
- 596 (x6)
- 588 (x8)
- NA 510 (x10)
- EUR 452 (x12)
- ASIA

WW ▶ Thule Sweden AB, Box 69, 330 33 Hillerstorp, SWEDEN
 NA ▶ Thule Inc., 42 Silvermine Road, Seymour, Connecticut 06483, USA

info@thule.com
 customer.service@thule.com

www.thule.com