

Kit 3007

VW Polo, 3-dr Hatchback, 95-01

VW Polo, 5-dr Hatchback, 95-01

VW Caddy (Mk.II), 3-dr Van, 96-03

VW Caddy (Mk.II), 3-dr Estate, 96-03

SEAT Inca (Mk.II), 3-dr Van, 96-03

SEAT Inca (Mk.II), 3-dr Estate, 96-03

This Kit is only for vehicles with fixpoint mounting.

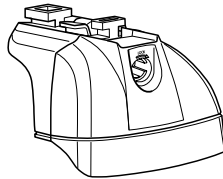

**460R
753**

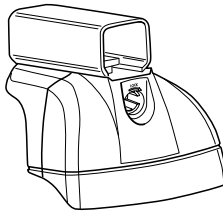
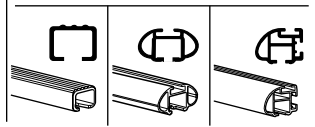

460

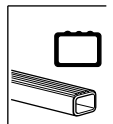

VW Polo, 3-dr Hatchback, 95-01
 VW Polo, 5-dr Hatchback, 95-01

Max.
50kg/110 lbs

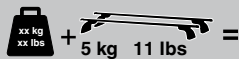

VW Caddy (Mk.II), 3-dr Van, 96-03
 VW Caddy (Mk.II), 3-dr Estate, 96-03
 SEAT Inca (Mk.II), 3-dr Van, 96-03
 SEAT Inca (Mk.II), 3-dr Estate, 96-03

Max.
70kg/154 lbs

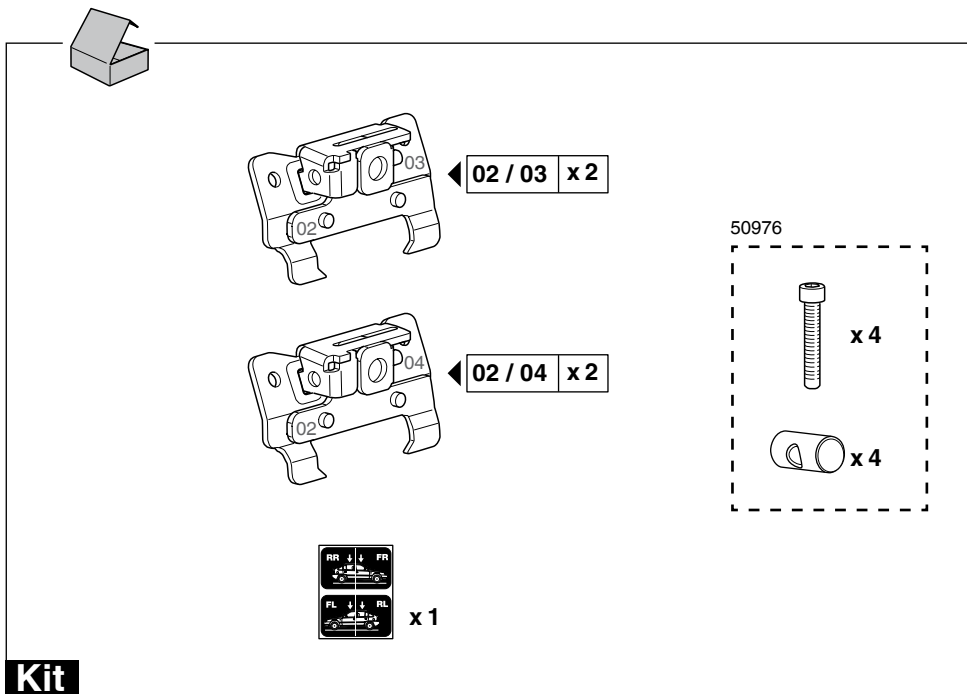
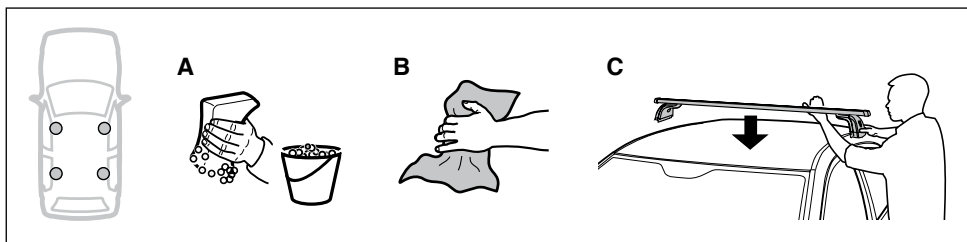
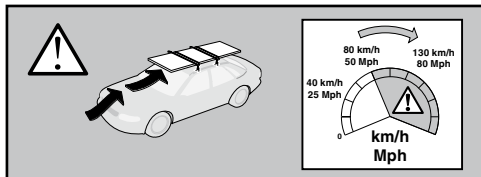
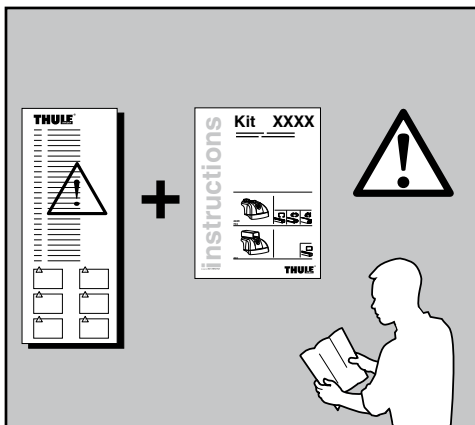

Kit



753



x4



x4



x4



x8

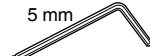

x1



x4



x1

460R

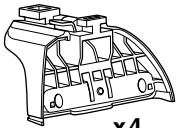

x4



x4



x4



x8



x1



x4

460

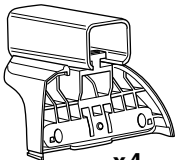

x4



x4



x4



x8



x1



x4



x2



x2



x2



x2



x2



x2

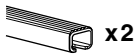

x2

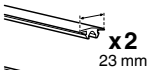

x2

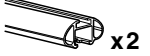

x2

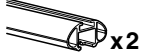

x2



x2



x4

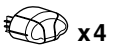

x4



x4

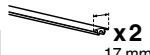

x2



x2



x2

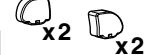

x2



x2



x4



x4

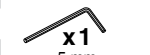

x1

1

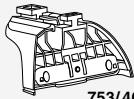

753/460R

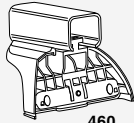

460

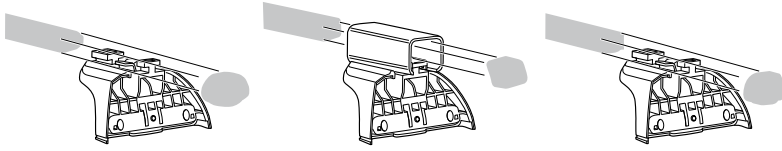

x4

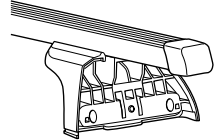
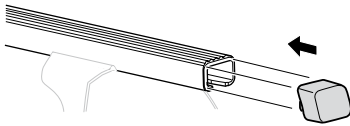

x4

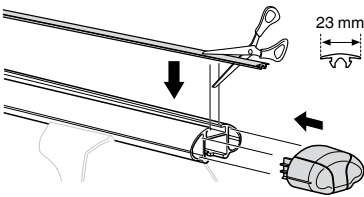

23 mm

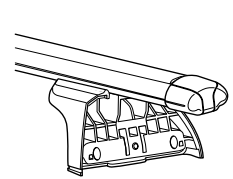
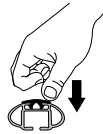

x4

x4

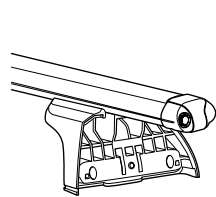
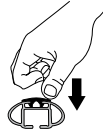
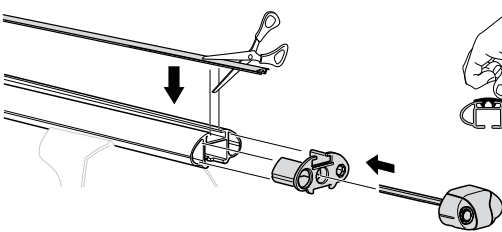

x4

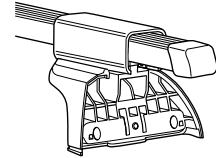
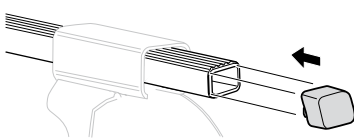

x2

x2

x4

x4

x1

5 mm

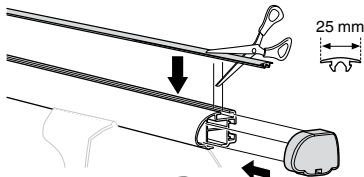

25 mm

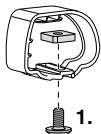
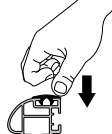

1.

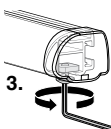

2.

3.

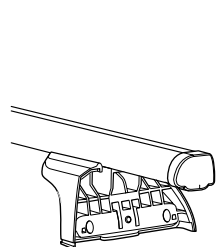

2

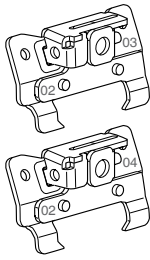

02 / 03 x 2

02 / 04 x 2

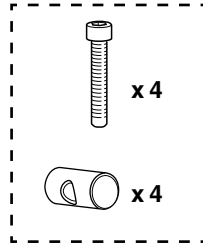

x 4

x 4

16 mm x 8



x 1



02 / 04



FL

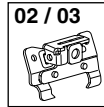

02 / 03



FR



02 / 03



RL

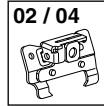

02 / 04



RR

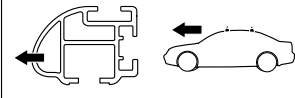

i

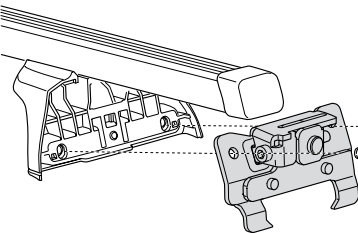
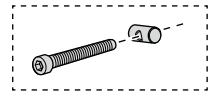
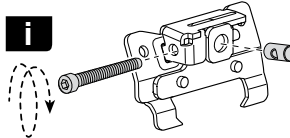

i

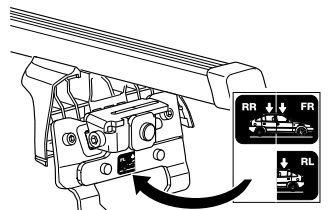

i

GB Only a few turns
D Nur wenige Umdrehungen
F Quelques tours uniquement
NL Slechts enkele slagen
I Solo qualche giro
E Sólo algunas vueltas
PT Noções básicas
S Endast några varv
FIN Vain muutama kierros

EST Ainult mõni pööre
LAT Tikai dažī apgriezieni
LIT Tik keli pasukimai
PL Wystarczy kilka obrotów
RU Достаточно нескольких оборотов
CZ Pouze několik otáček
SK Len niekoľko otáčok
SLO Le nekaj obratov

HR Samo nekoliko okreta
HU Csak néhány fordítás
GR Μόνο μερικές στροφές
TR Yalnız birkaç kez çevirm
中文 只有几个转向
한국어 두 세번만
日本語 数回転のみ
ไทย หมุนเพียงไม่กี่รอบ

3

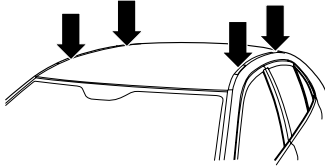

VW Polo,
3-dr Hatchback, 95-00
VW Polo,
5-dr Hatchback, 95-00

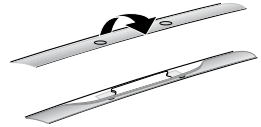

VW Polo,
3-dr Hatchback, 00-01
VW Polo,
5-dr Hatchback, 00-01

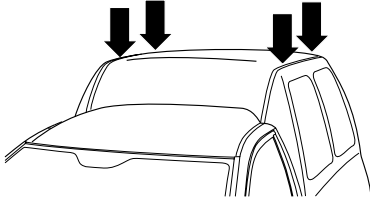
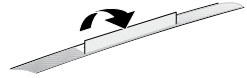

VW Caddy (Mk.II),
3-dr Van, 96-03
VW Caddy (Mk.II),
3-dr Estate, 96-03
SEAT Inca (Mk.II),
3-dr Van, 96-03
SEAT Inca (Mk.II),
3-dr Estate, 96-03

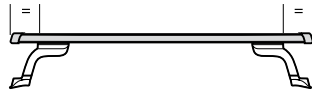
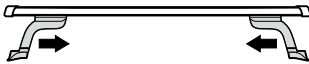
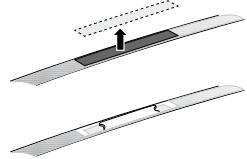

A

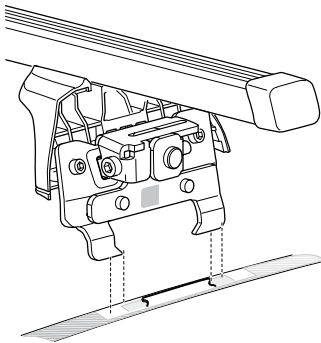

B

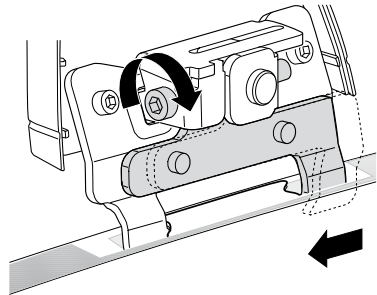

C

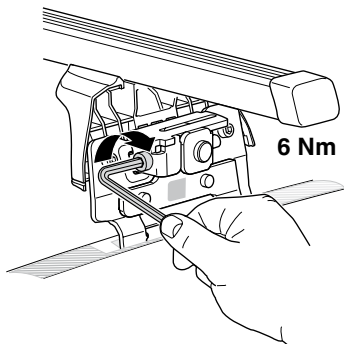

D

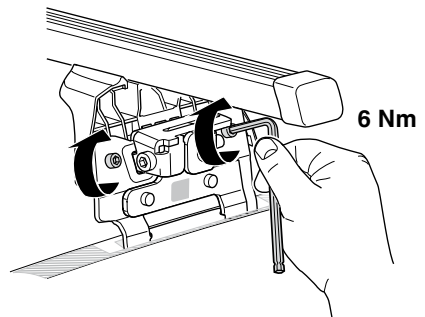

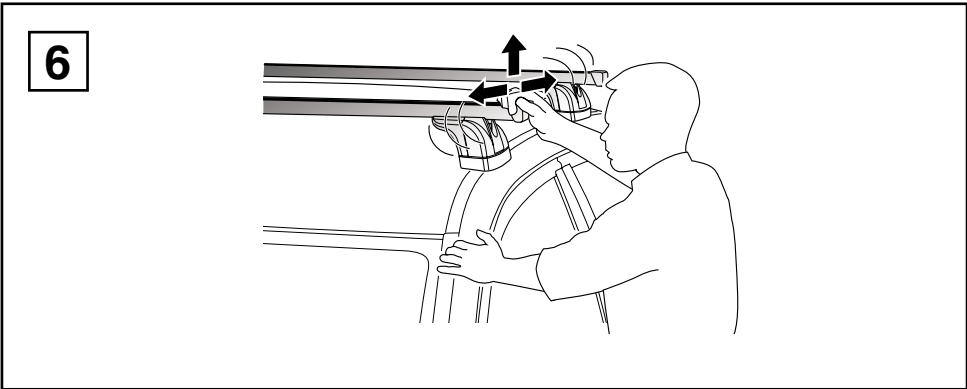
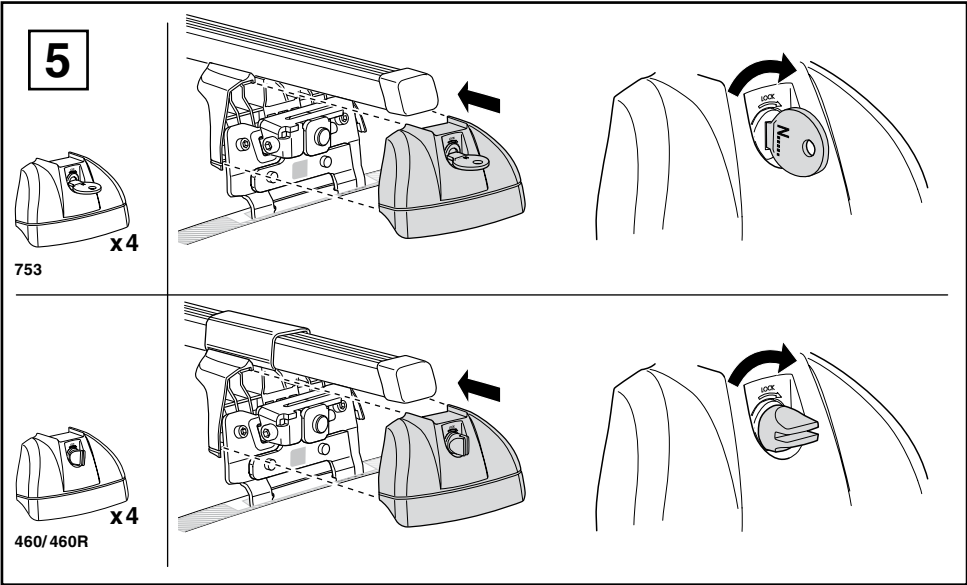
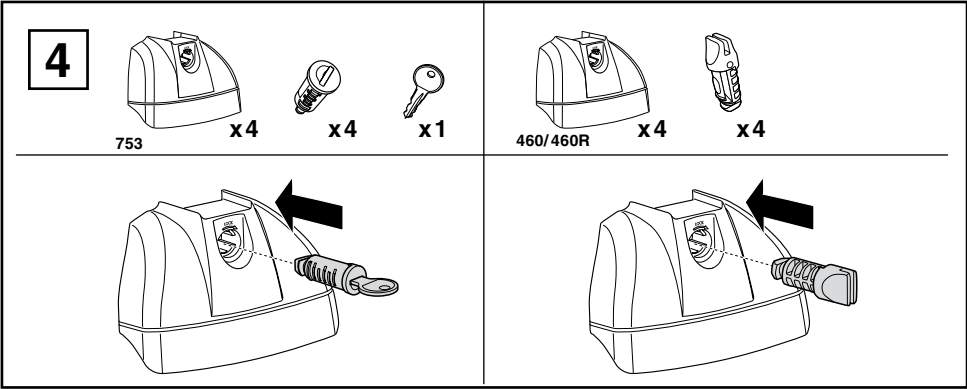

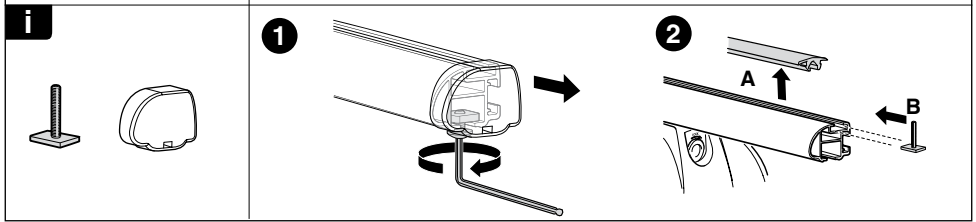
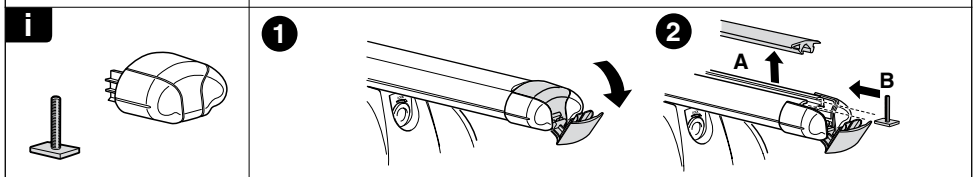
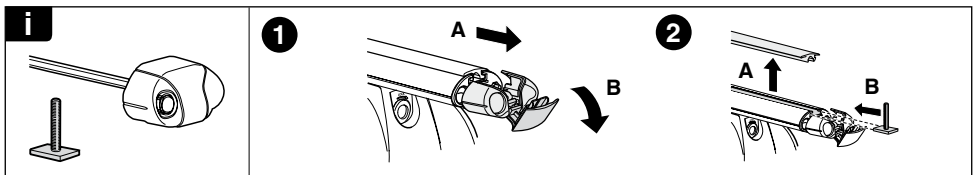
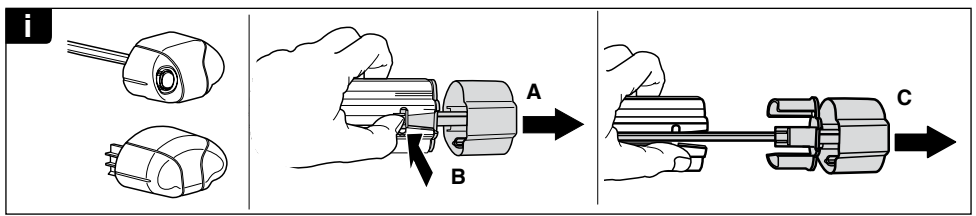
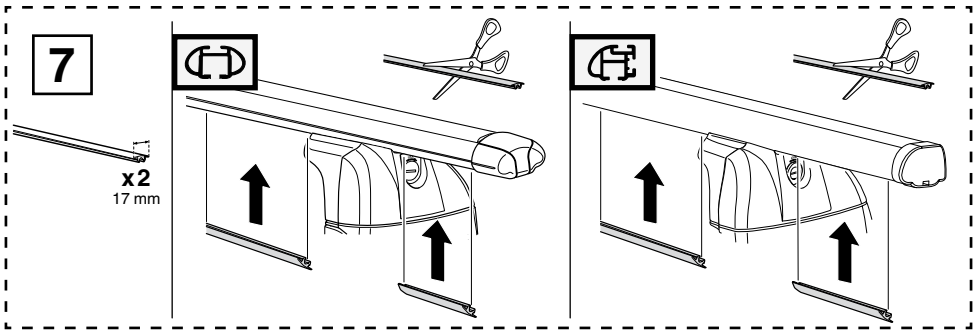

THULE
SWEDEN

**ONE
KEY
SYSTEM**

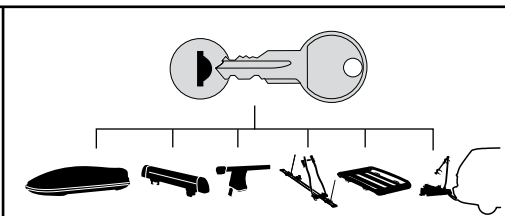

- 544 (x4)
- 596 (x6)
- 588 (x8)
- 510 (x10)
- 510 (x10)
- 452 (x12)