

# Kit 1447

FIAT Linea, 4-dr Sedan, 07-

480R  
754

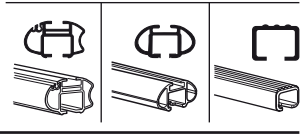
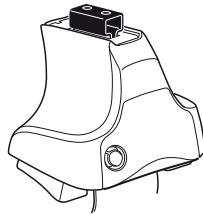

480

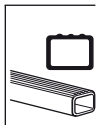
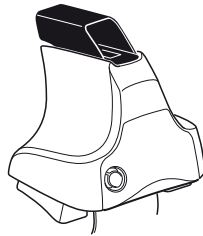

750

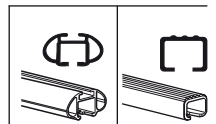
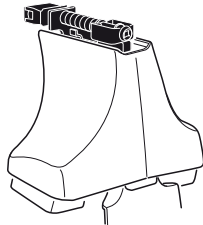

x2 x2 x2 x2 x4	x2	x2 x2 x4 x4	x2 x2	x2

				x1

**Kit**



**3**

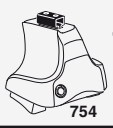

754

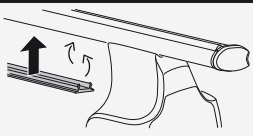
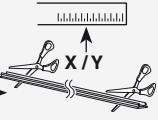

750

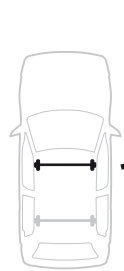

**1**

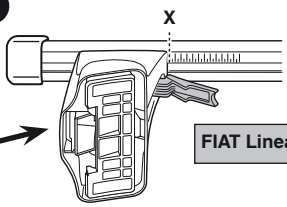

**2**



FIAT Linea, 4-dr Sedan, 07-

X
30,5

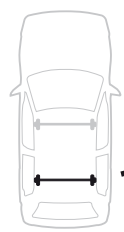

**1**

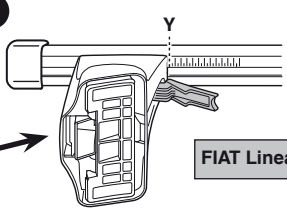

**2**

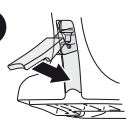

FIAT Linea, 4-dr Sedan, 07-

Y
25



480R



480

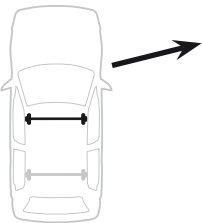

**1**

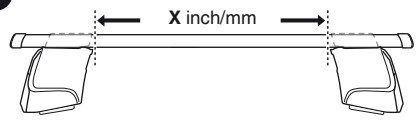

**2**



FIAT Linea, 4-dr Sedan, 07-

X inch	X mm
37 7/8"	956 mm

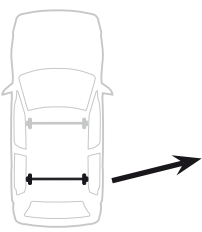

**1**

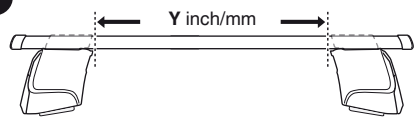

**2**

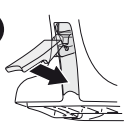

FIAT Linea, 4-dr Sedan, 07-

Y inch	Y mm
35 1/2"	901 mm

4

FIAT Linea, 4-dr Sedan, 07-

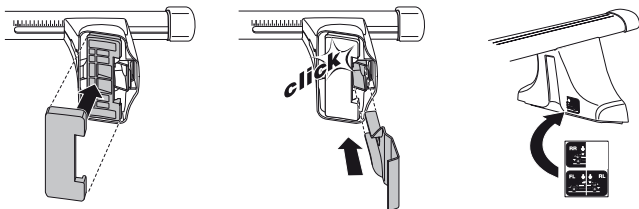
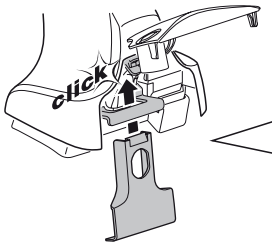
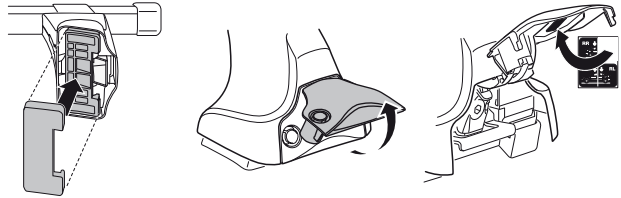
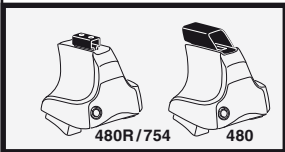
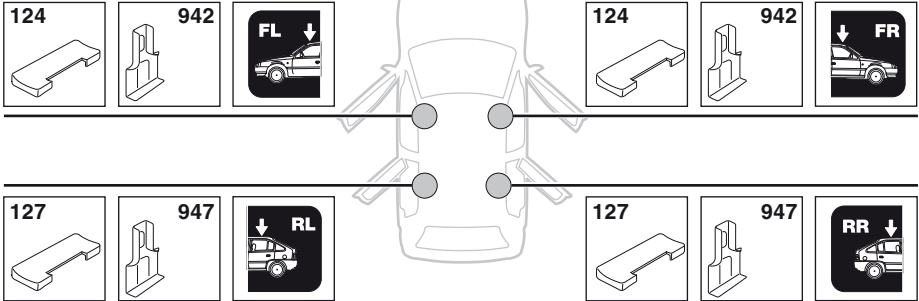

5

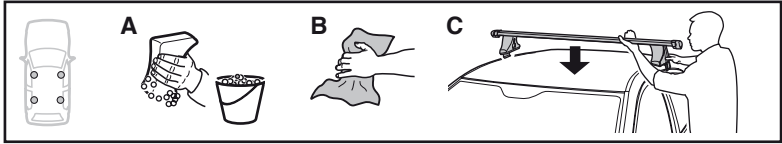

	X mm	Y mm	X inch	Y inch
FIAT Linea, 4-dr Sedan, 07-	250 mm	795 mm	9 7/8"	31 1/4"

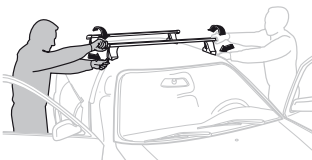
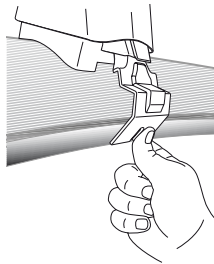
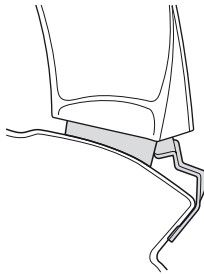
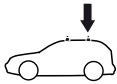
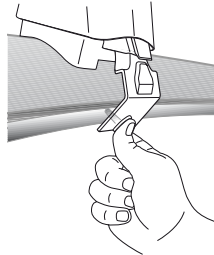
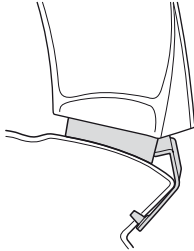
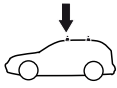
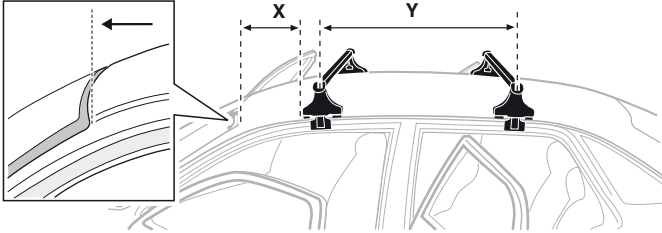

- GB/US** Tighten alternately
- D** Die Schrauben abwechselnd anziehen
- F** Serrer alternativement chaque côté
- NL** Afwisselend aan de linker- en de rechterkant aandraaien
- I** Alternare il serraggio delle viti
- E** Apretar alternativamente
- PT** Aperte alternadamente
- S** Dra åt växelvis
- FIN** Kierrä vuorotellen
- EST** Pinguldage vaheldumisi
- LAT** Pievelciēt pamišus
- LIT** Užsukinėkite pakaitomis
- PL** Śruby dokręcaj naprzemiennie
- RU** Затягивайте попеременно

- CZ** Pokrétla bagażnika dokręcaj dokręcaj naprzemiennie.
- SK** Doťahujte striedavo
- SLO** Privijajte izmenično.
- HR** Naizmjenično zategnite
- HU** Egy mástól függetlenül szorítandó
- GR** Σφιγγετε εναλλάξ
- TR** Dönüşümlü sıkın

**中文** 交替拧紧

**한국어** 번갈아 가며 조이십시오.

**日本語** 交互に締め付けてください。

**ไทย** ชั้สลับไปสลับ

6



480R/754



480

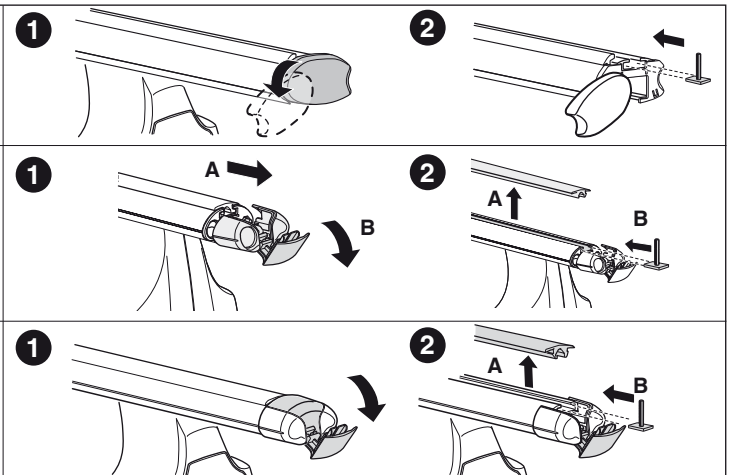
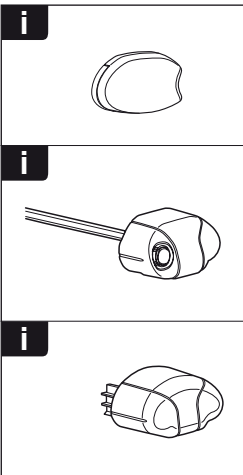
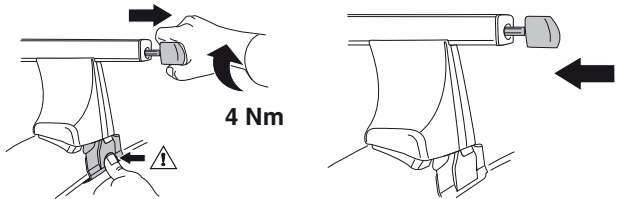
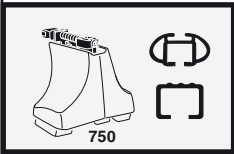
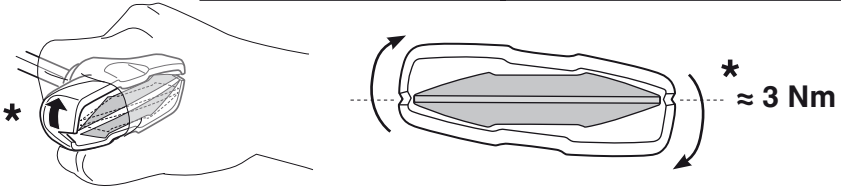
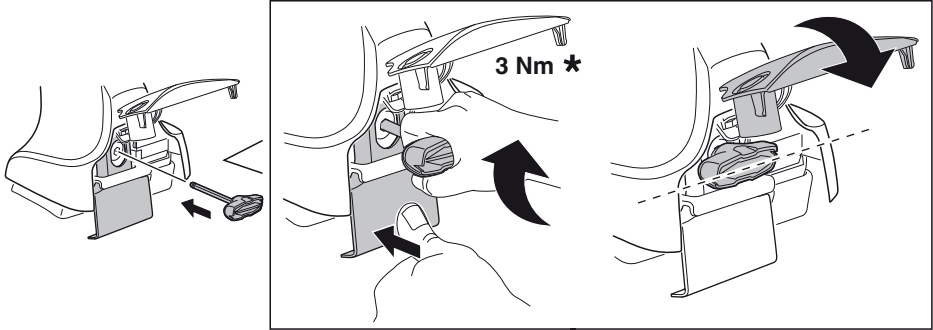



**THULE**  
SWEDEN  
**ONE  
KEY  
SYSTEM**

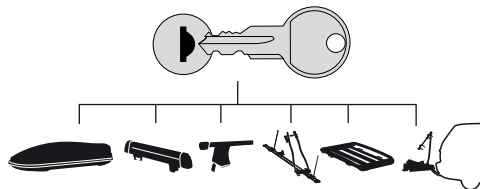

- 544 (x4)
- 596 (x6)
- 588 (x8)
- NA 510 (x10)
- EUR 452 (x12)
- ASIA

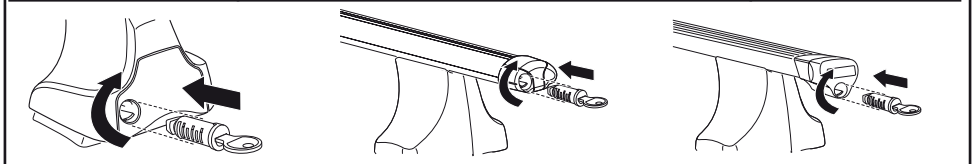

WW ▶ Thule Sweden AB, Box 69, 330 33 Hillerstorp, SWEDEN  
NA ▶ Thule Inc., 42 Silvermine Road, Seymour, Connecticut 06483, USA

info@thule.com  
customer.service@thule.com

www.thule.com