

Kit 3088

CHEVROLET Combo, 4-dr Van, 12–

FIAT Doblo, 4-dr Van, 10–

OPEL Combo, 4-dr Van, 12–

VAUXHALL Combo, 4-dr Van, 12–

This Kit is only for vehicles with fixpoint mounting.

460R
753

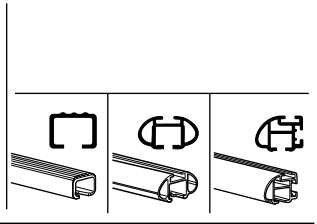
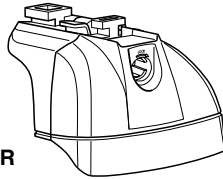

460

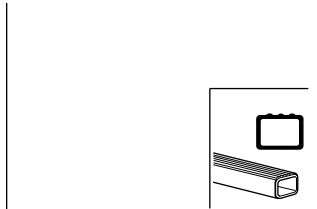
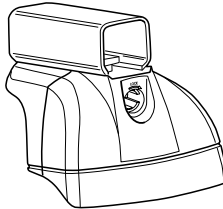

751

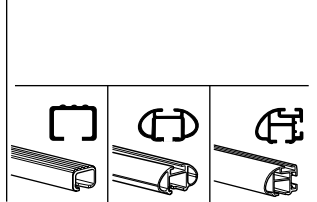
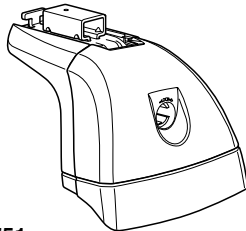

THULE[®]
SWEDEN

6 kg / 13 lbs + xx kg / xx lbs =

Max. 100 kg
Max. 220 lbs

9 kg / 20 lbs + xx kg / xx lbs =

Max. 150 kg
Max. 330 lbs

THULE Kit XXXX

instructions

THULE

80 km/h 130 km/h
50 Mph 80 Mph

40 km/h 25 Mph

km/h Mph

A **B** **C**

Kit

04 x 4

50596 x 8

x 4

x 1

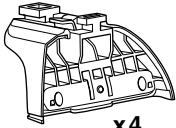

753

x4



x4



x4



16 mm
x8



5 mm
x1



x4



x1

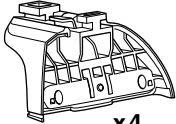

460R

x4



x4



x4



16 mm
x8



5 mm
x1



x4

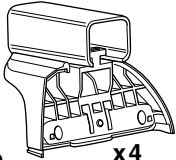

460

x4

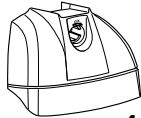

x4



x4



16 mm
x8



5 mm
x1



x4

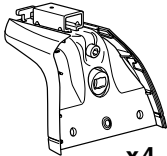

751

x4



x4



x4



12 mm
x8



5 mm
x1



x4



x1

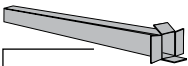

x2



x1

17 mm



x2

23 mm



x2

23 mm



x2



x2

17 mm

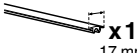
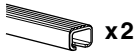

x2

23 mm

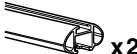

x2



x2

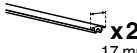

x2

25 mm



x2



x4

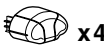

x4



x4



x2

x2

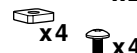

x4

x4



x1
5 mm

1

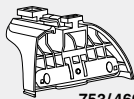

753/460R

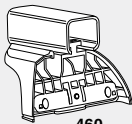

460

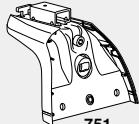

751

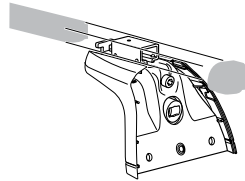
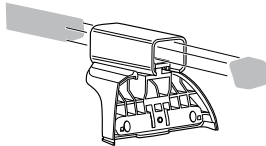
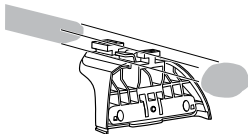

x4

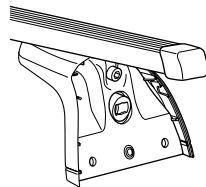
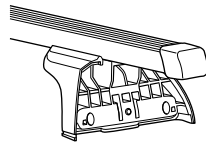
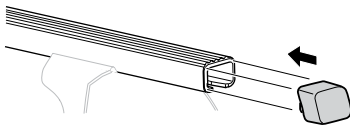

x4

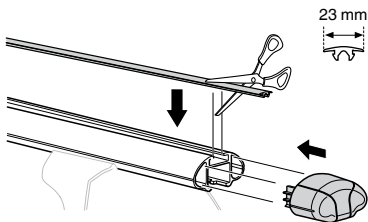

23 mm

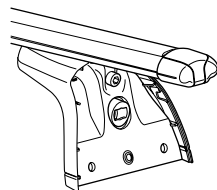
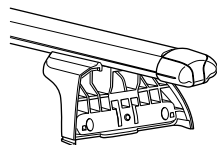
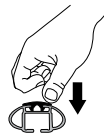



x4

x4

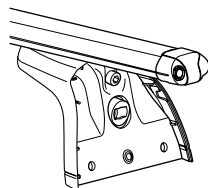
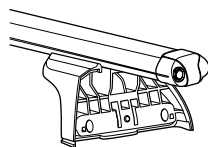
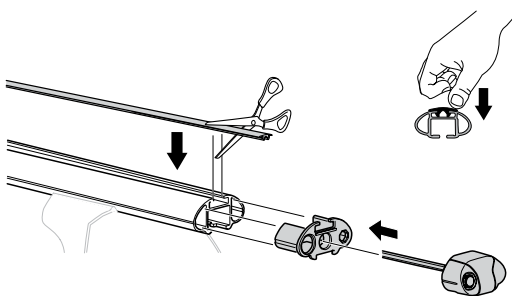

x4

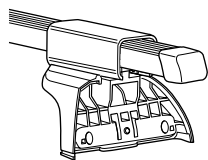
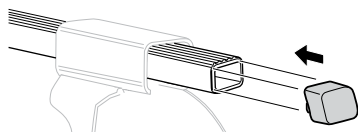

x2

x2

x4

x4

x1
5 mm

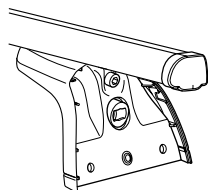
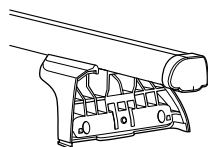
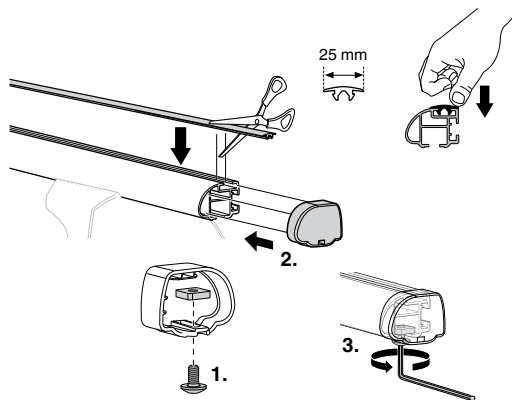

2

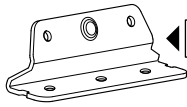

04 x 4

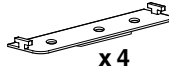

x 4



16 mm

x 8



x 1

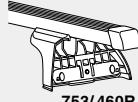

753/460R

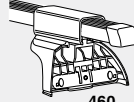

460

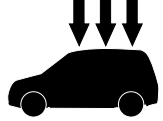

04

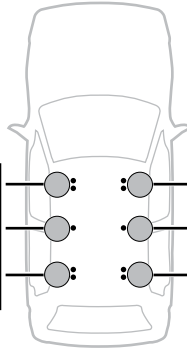
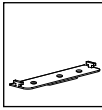
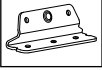

04

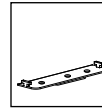
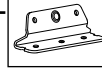

04

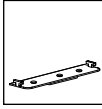
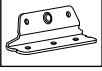

04

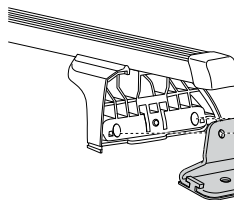
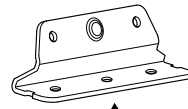
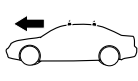
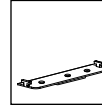
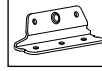

i

i

- GB** Only a few turns
D Nur wenige Umdrehungen
F Quelques tours uniquement
NL Slechts enkele slagen
I Solo qualche giro
E Sólo algunas vueltas
PT Noções básicas
S Endast några varv
FIN Vain muutama kierros
EST Ainult mõni pööre
LAT Tikai daži apgriezieni
LIT Tik keli pasukimai
PL Wystarczy kilka obrotów
RU Достаточно нескольких оборотов
CZ Pouze několik otáček
SK Len niekoľko otáčok
SLO Le nekaj obratov

- HR** Samo nekoliko okreta
HU Csak néhány fordítás
GR Μόνο μερικές στροφές
TR Yalnız birkaç kez çevirm
中文 只有几个转向
한국어 두 세번만
日本語 数回転のみ
ไทย หมุนเพียงไม่กี่รอบ

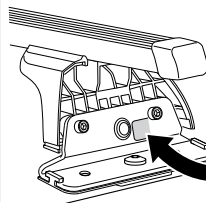

2

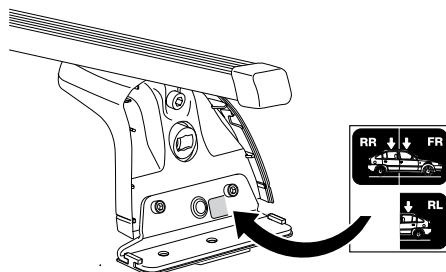
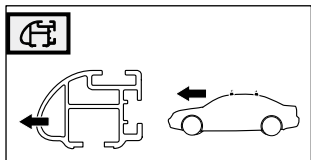
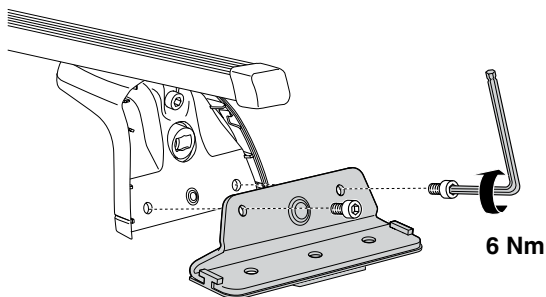
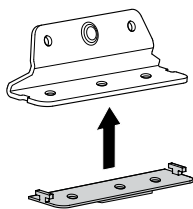
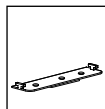
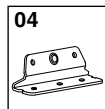
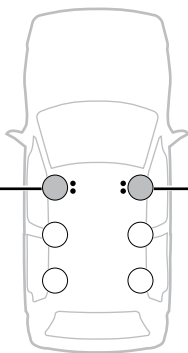
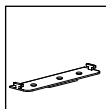
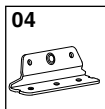
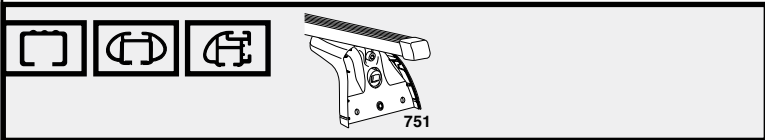
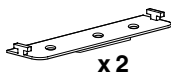
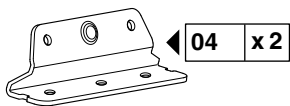

3

 **x6**
(x8)

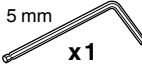
5 mm  **x1**

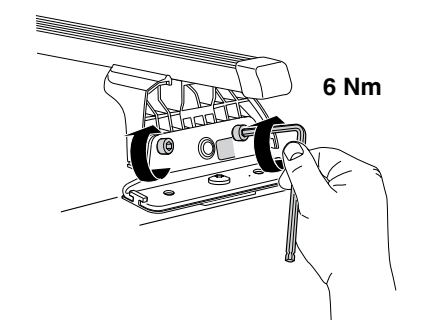
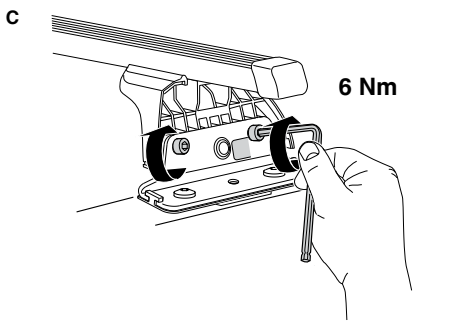
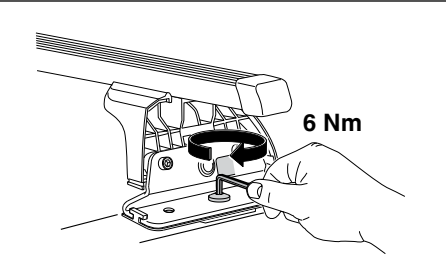
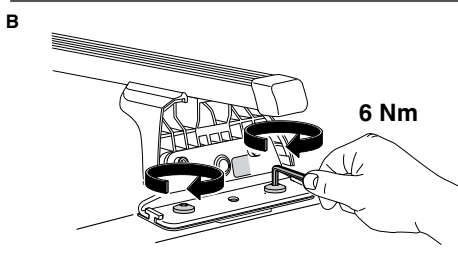
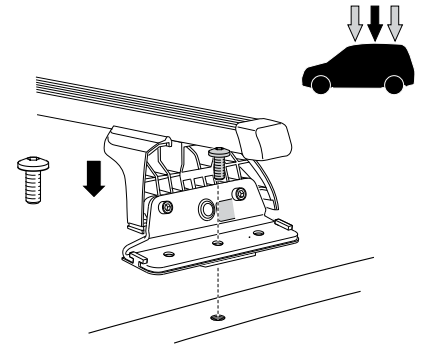
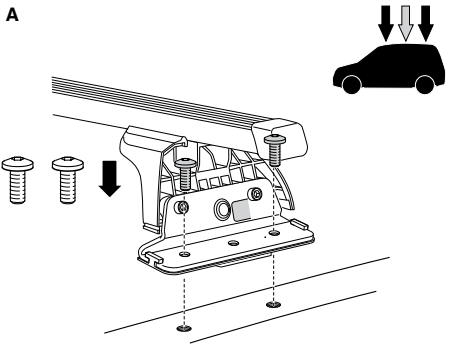
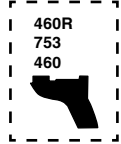
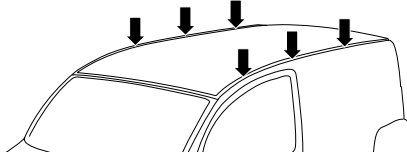
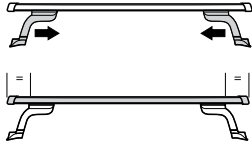

3

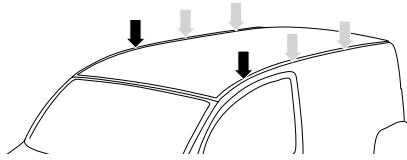
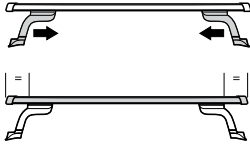
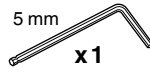

A

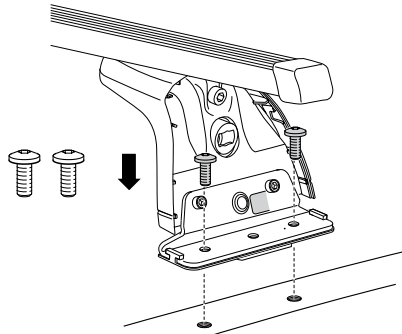
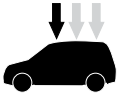

B

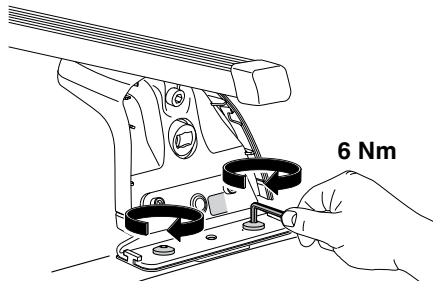

C

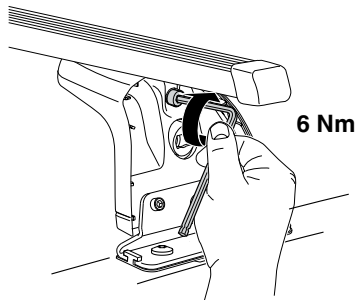

4



x4

753



x4



x1

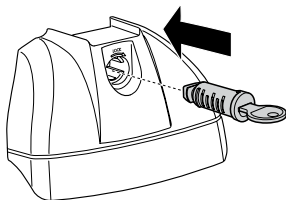

x4

460/460R



x4

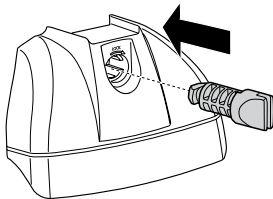

x4

751



x4



x1

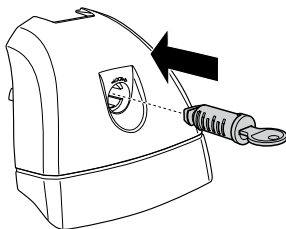

5



753 x4

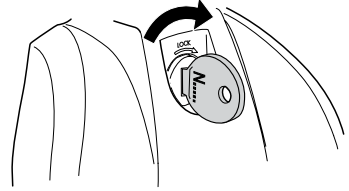
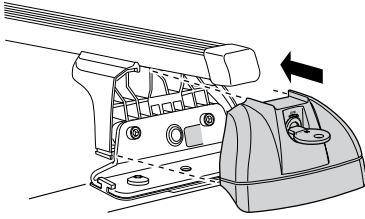

460/460R x4

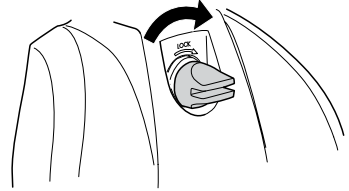
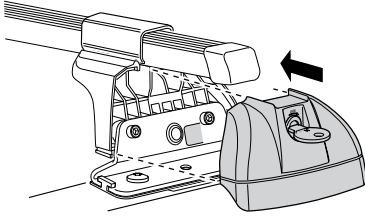

5 mm



x1

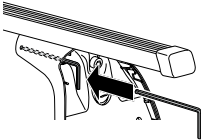

751 x4

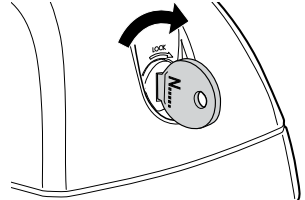
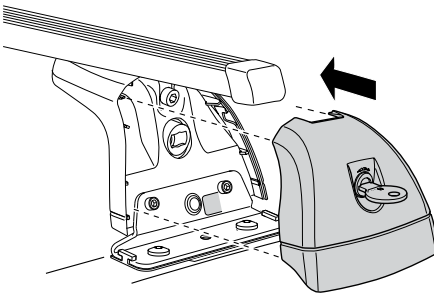

6

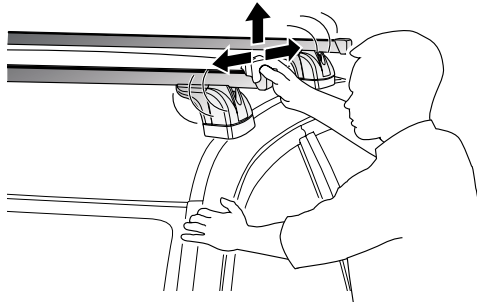

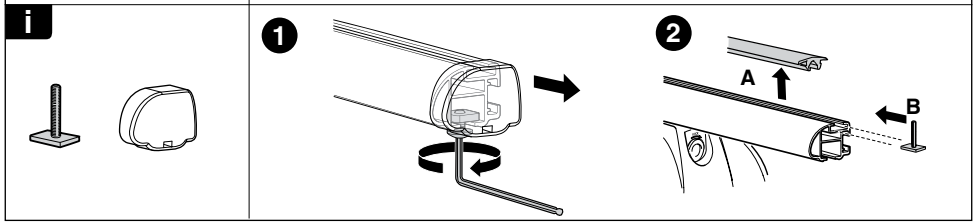
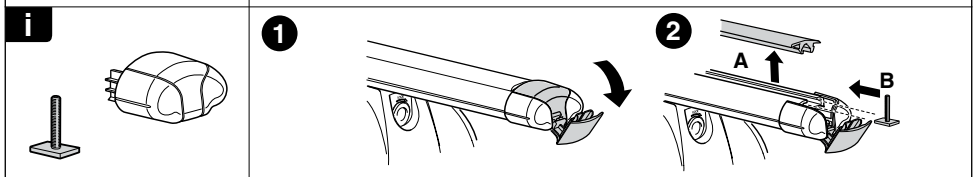
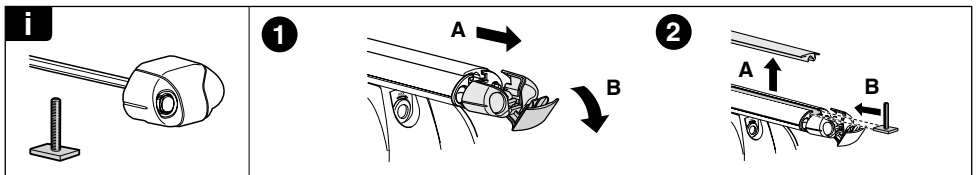
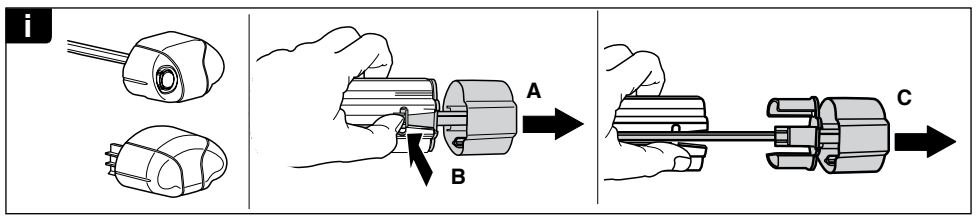
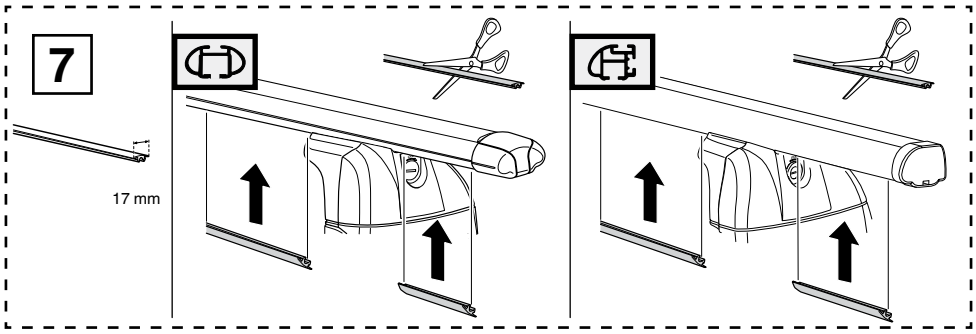

THULE
SWEDEN
**ONE
KEY
SYSTEM**

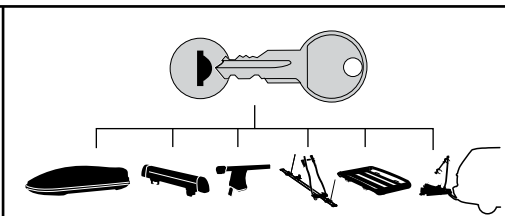

- 544 (x4)
- 596 (x6)
- 588 (x8)
- NA 510 (x10)
- EUR ASIA 452 (x12)