

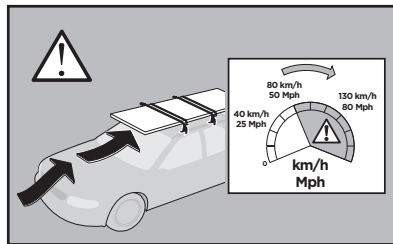

Thule Rapid System Kit 1562

> Instructions

HONDA Insight, 5-dr Hatchback, 09-

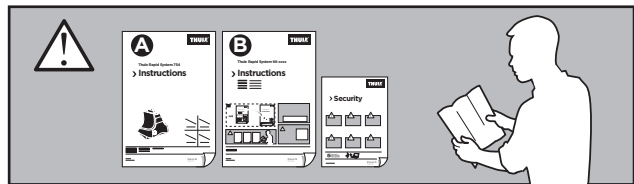
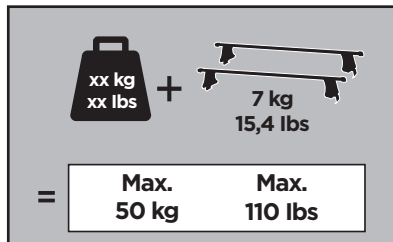

ISO 11154-E

141562

C.20130703
519-1562-02

Bring your life
thule.com



999 x2

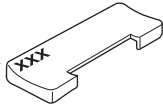

140 x2



x1

1041 x2

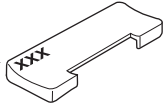

141 x2



x1

1

	X (scale)	X (mm)	X (inch)
HONDA Insight, 5-dr Hatchback, 09-	40	1060	41 ³ / ₄

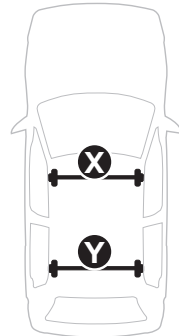
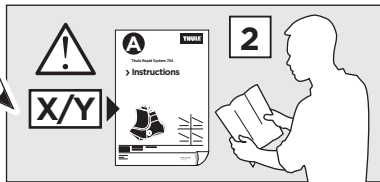
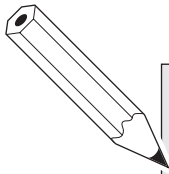

	Y (scale)	Y (mm)	Y (inch)
HONDA Insight, 5-dr Hatchback, 09-	38	1035	40 ³ / ₄

2

HONDA Insight, 5-dr Hatchback, 09-

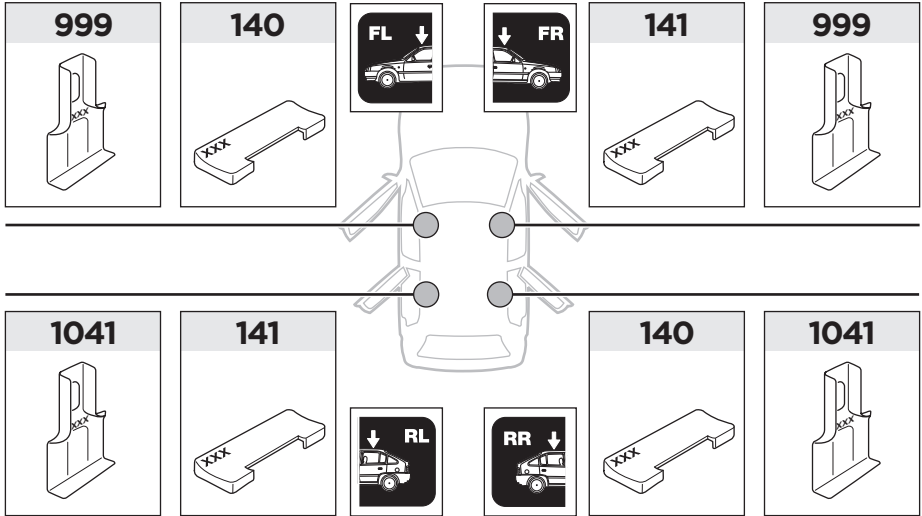

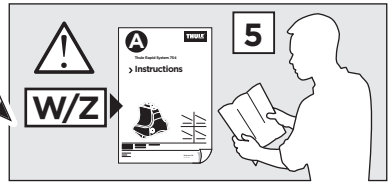
3

	W (mm)	Z (mm)	W (inch)	Z (inch)
HONDA Insight, 5-dr Hatchback, 09-	325	750	12 ³/₄	27 ¹/₂

