

Kit 1521

FORD F-150, 4-dr Super Cab, 09–
FORD F-150, 4-dr Super Crew Cab, 09–

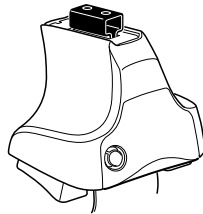

754 Rapid System
480R Rapid Traverse (North America)

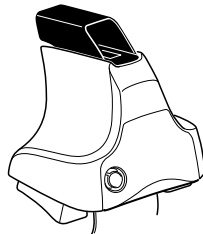
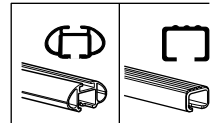

480 Traverse (North America)

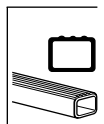

1



2



754 Rapid System
480R Rapid Traverse
(North America)

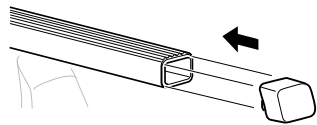
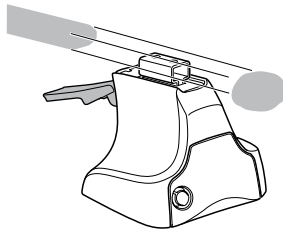

x4

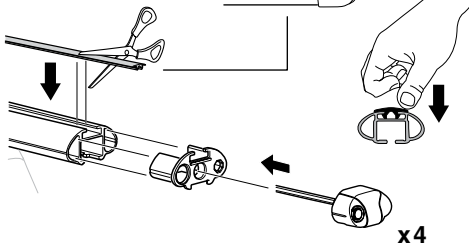
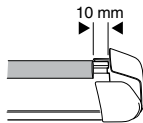

x4

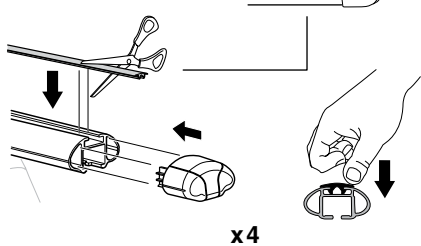
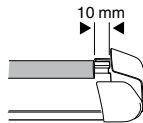
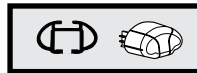

x4



480 Traverse
(North America)

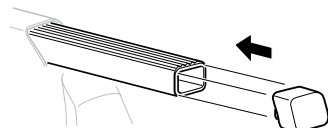
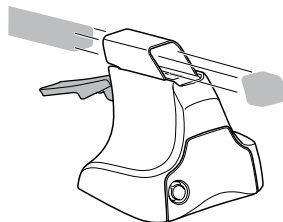

x4

3



754 Rapid System

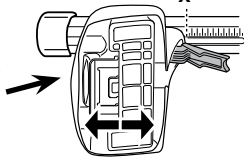

	X
FORD F-150, 4-dr Super Cab, 09–	57,5
FORD F-150, 4-dr Super Crew Cab, 09–	57,5

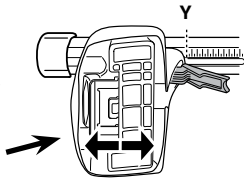

	Y
FORD F-150, 4-dr Super Cab, 09–	57,5
FORD F-150, 4-dr Super Crew Cab, 09–	57,5

3



480R Rapid Traverse



480 Traverse

(North America)

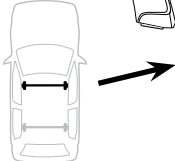
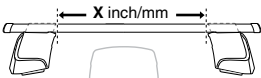

	X inch	X mm
FORD F-150, 4-dr Super Cab, 09–	48 1/4"	1226 mm
FORD F-150, 4-dr Super Crew Cab, 09–	48 1/4"	1226 mm

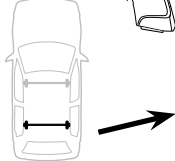

	Y inch	Y mm
FORD F-150, 4-dr Super Cab, 09–	48 1/4"	1226 mm
FORD F-150, 4-dr Super Crew Cab, 09–	48 1/4"	1226 mm

4

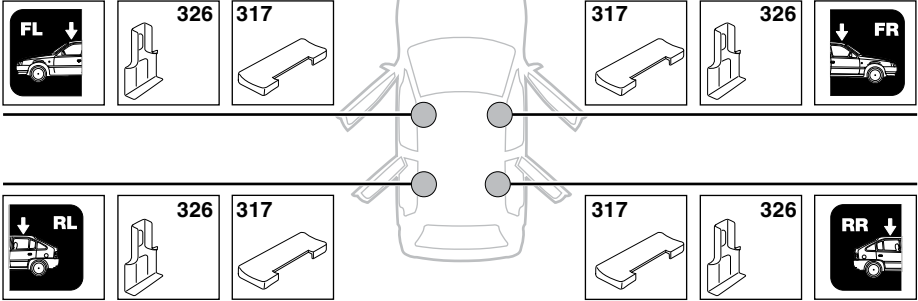

5**FORD F-150, 4-dr Super Cab, 09–**
FORD F-150, 4-dr Super Crew Cab, 09–

6

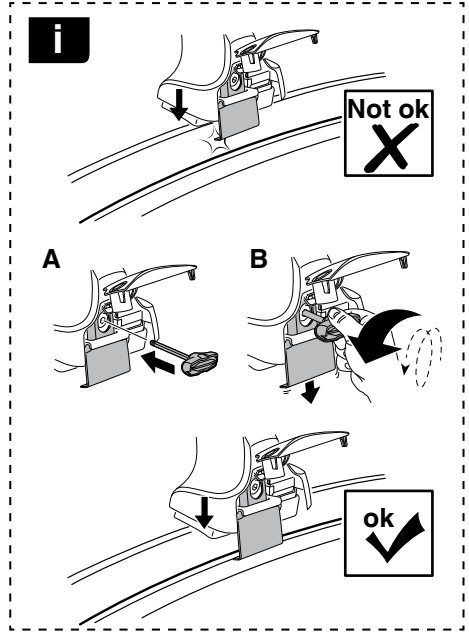

	X mm	Y mm	X inch	Y inch
FORD F-150, 4-dr Super Cab, 09-	255 mm	760 mm	10"	30"
FORD F-150, 4-dr Super Crew Cab, 09-	255 mm	760 mm	10"	30"

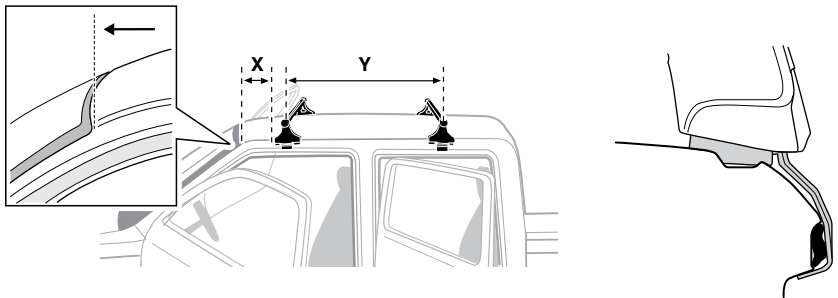

7

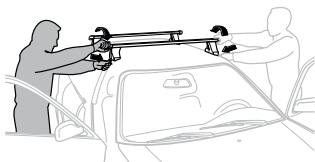

GB/US Tighten alternately
D Die Schrauben abwechselnd anziehen
F Serrer alternativement chaque côté
NL Afwisselend aan de linker- en de rechterkant aandraaien
I Alternare il serraggio delle viti
E Apertar alternativamente
PT Aperte alternadamente
S Dra åt växelvis
FIN Kierrä vuorotellen
EST Pinguldage vaheldumisi
LAT Pieļieciet pamišus
LIT Užsukinėkite pakaitomis
PL Śruby dokręcaj naprzemiennie
RU Затягивайте попеременно

CZ Pokręťta bagażnika dokręcaj naprzemiennie.
SK Dofahajte striedavo
SLO Privijajte izmenično.
HR Naizmjenočno zategnite
HU Egymástól függetlenül szorítandó
GR Σφιγίγτες εναλλάξ
TR Dönüşümlü sıkın

中文 交替拧紧

한국어 번갈아 가며 조이십시오.

日本語 交互に締め付けてください。

ไทย ชันในแบบสลับ

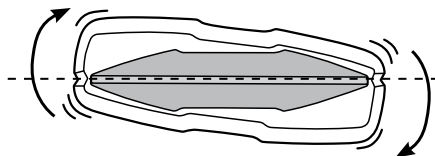
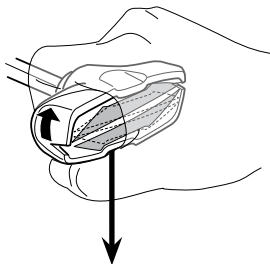
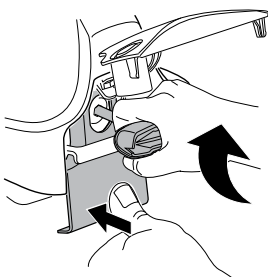
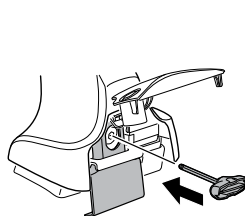

≈ 3 Nm

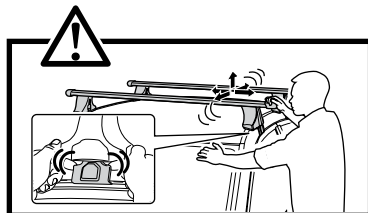
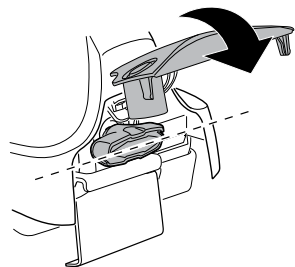

8



x1
17 mm

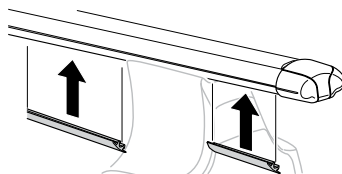
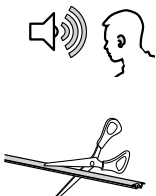



THULE
SWEDEN
**ONE
KEY
SYSTEM**



		(x4)
		(x6)
		(x8)
NA		(x10)
EUR		(x12)
ASIA		



WW ▶ Thule Sweden AB, Box 69, 330 33 Hillerstorp, SWEDEN
NA ▶ Thule Inc., 42 Silvermine Road, Seymour, Connecticut 06483, USA

info@thule.com
customer.service@thule.com

www.thule.com