

# instructions

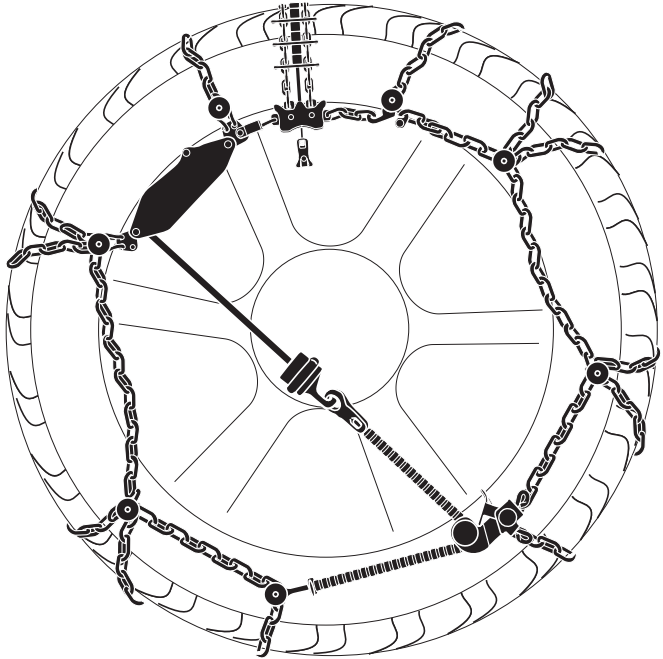

---

**19 800 383**

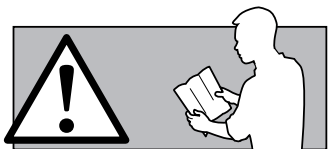

Optional

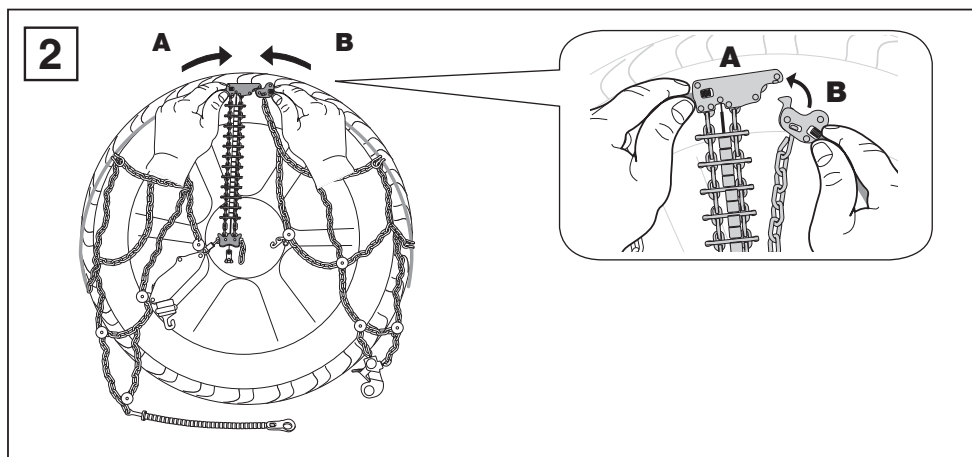
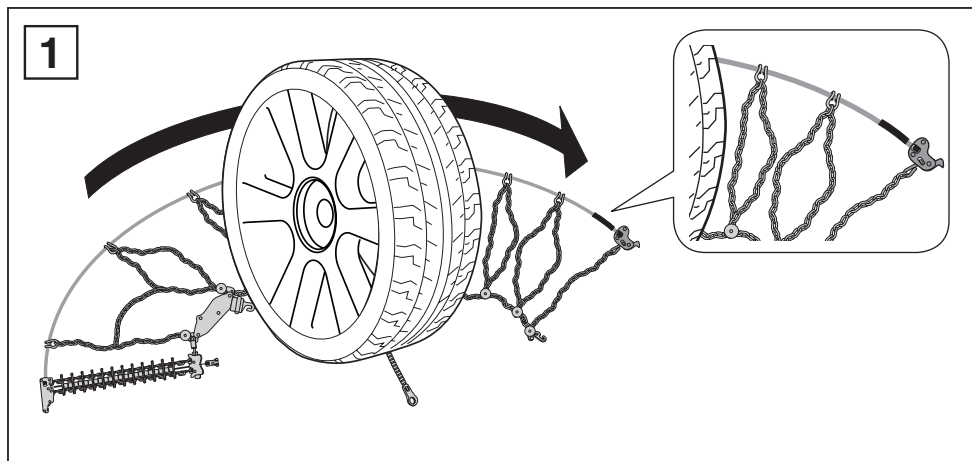
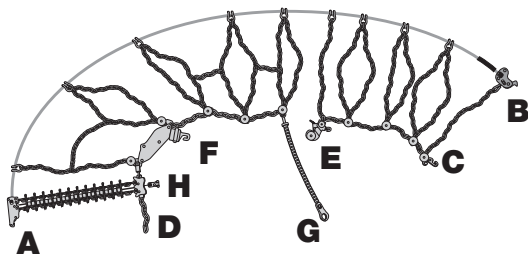
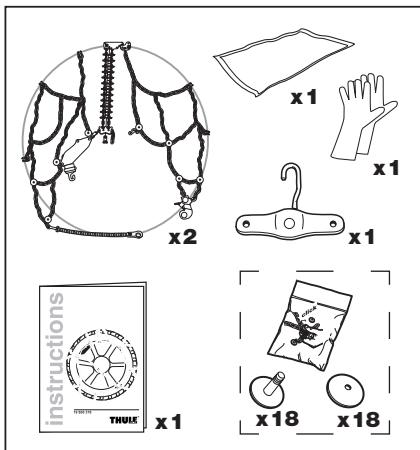
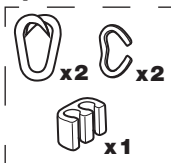

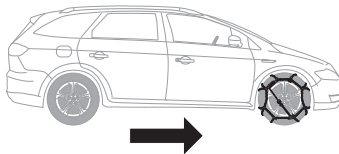
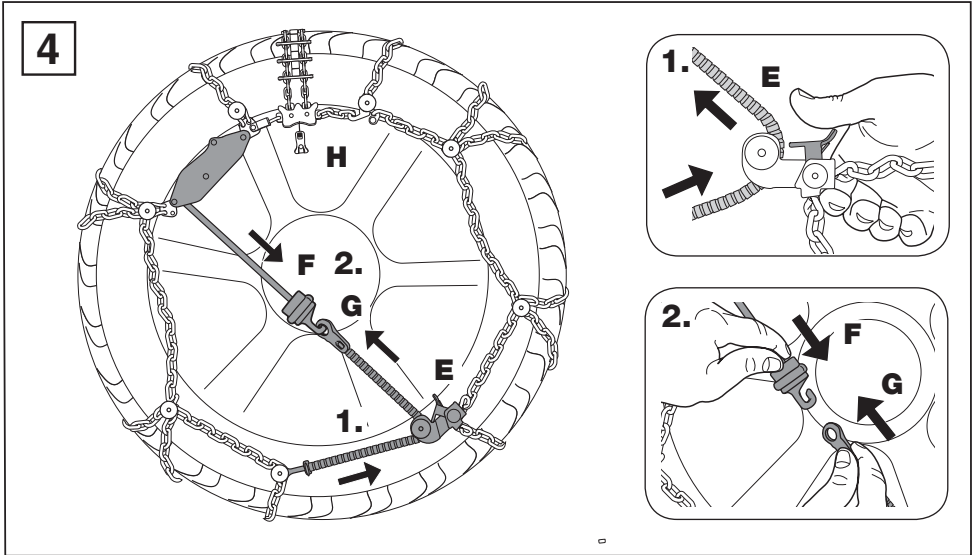
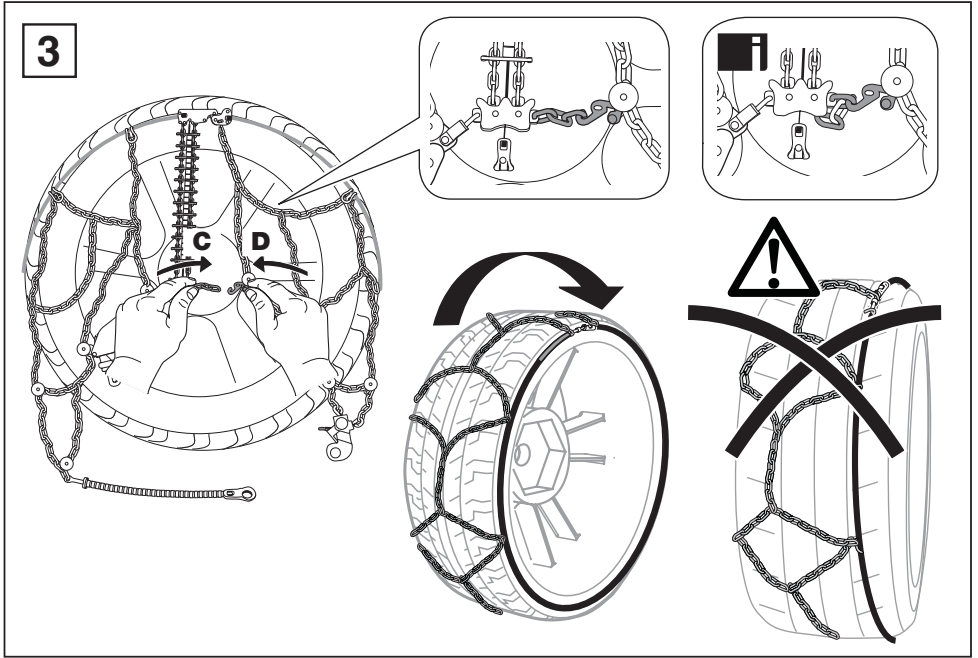

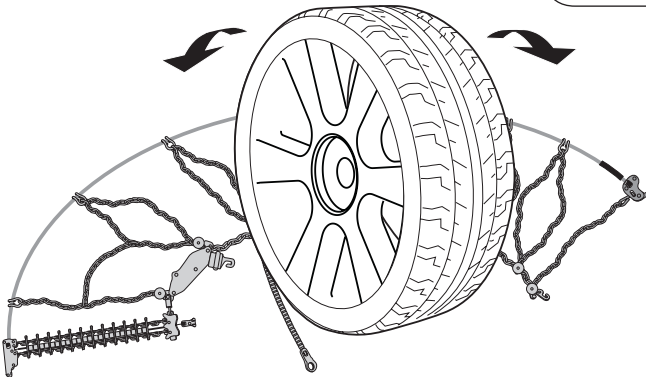
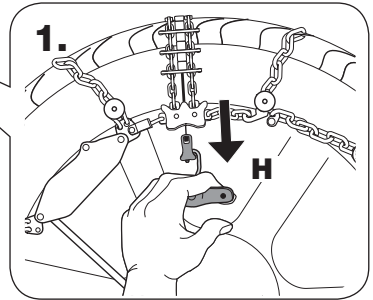
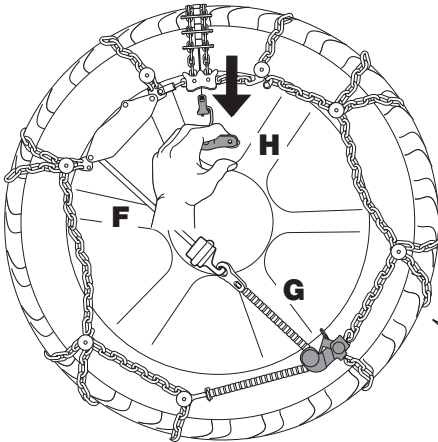
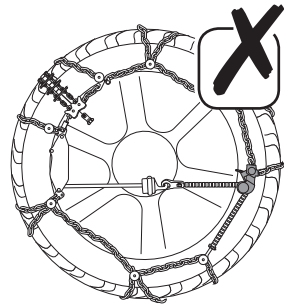
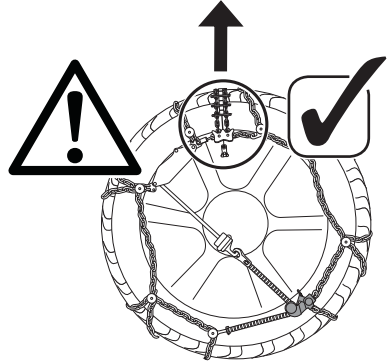
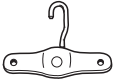
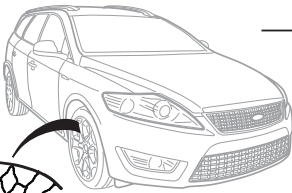

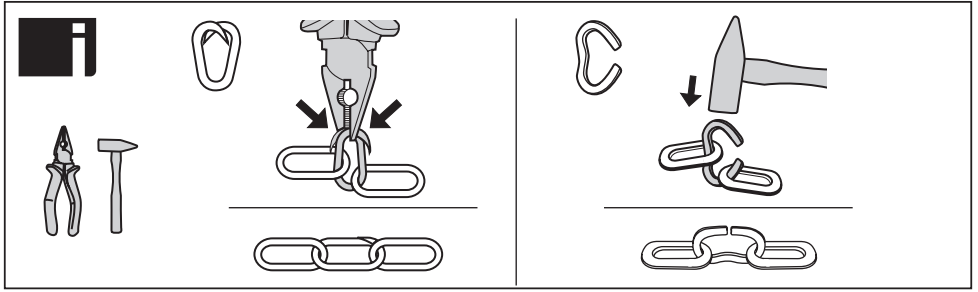

## OPTIONAL

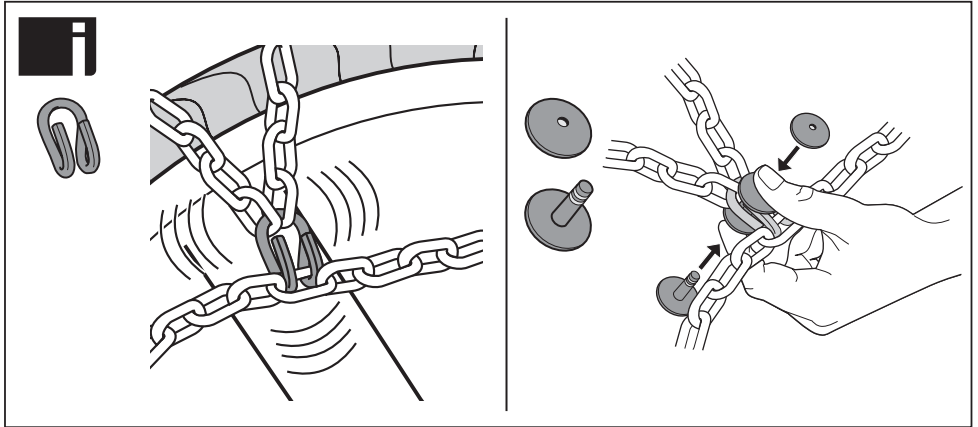



# INSTRUCTIONS AND RECOMMENDATIONS FOR USE

1.

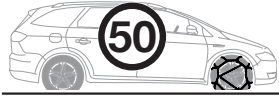

2.



4a

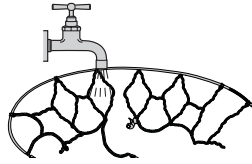

4b

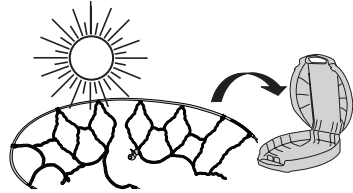

3.

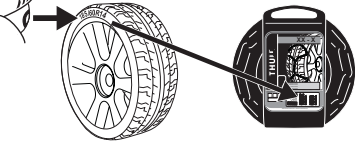

5.

**5** *års garanti*  
*years warranty*  
**Jahre Garantie**  
*ans de garantie*

6.

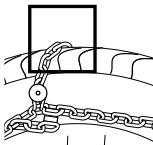

45%







Thule S.p.A Viale Lombardia, 8  
23847 Molteno - ITALY  
[www.thule.com](http://www.thule.com)