

# Kit 3022

- VOLKSWAGEN Caddy, 4-dr Van, 04-
- VOLKSWAGEN Caddy, 5-dr Van, 04-
- VOLKSWAGEN Caddy, 4-dr Estate, 04-
- VOLKSWAGEN Caddy, 5-dr Estate, 04-
- VOLKSWAGEN Caddy Maxi, 4-dr Van, 08-
- VOLKSWAGEN Caddy Maxi, 5-dr Van, 08-

This Kit is only for vehicles with fixpoint mounting.

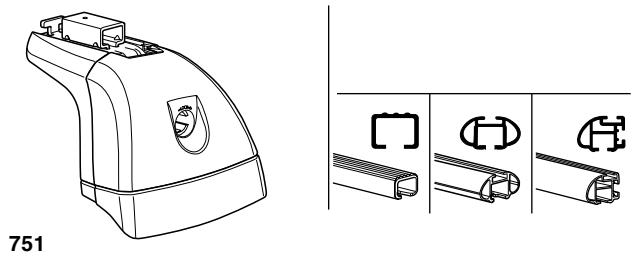
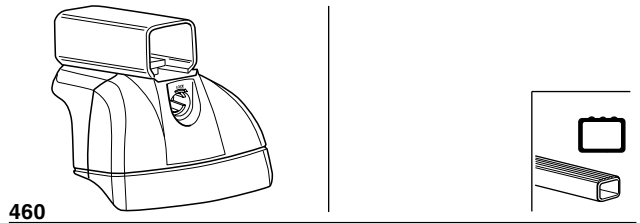
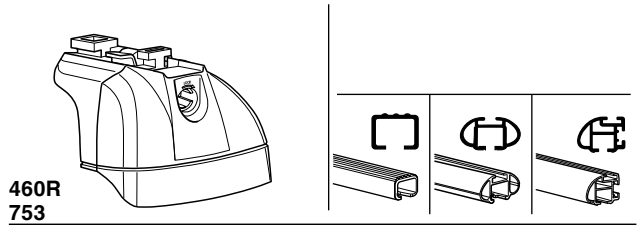

6 kg / 13 lbs + xx kg / xx lbs = Max. 100 kg / Max. 220 lbs

9 kg / 20 lbs + xx kg / xx lbs = Max. 150 kg / Max. 330 lbs

THULE Kit XXXX instructions

40 km/h 25 Mph 80 km/h 50 Mph 130 km/h 80 Mph

km/h Mph

A B C

21 x 4

07 x 4

50603 40 mm x 4

51346 x 4

50229 6 mm x 1

RR FR FL RL x 1

**Kit**

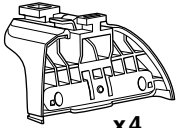
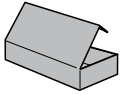

753

x4



x4



x4



16 mm  
x8



5 mm  
x1



x4



x1

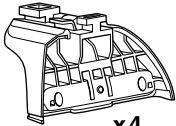

460R

x4



x4



x4



16 mm  
x8

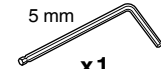

5 mm  
x1



x4

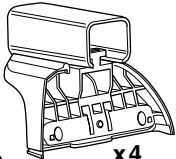

460

x4



x4



x4



16 mm  
x8



5 mm  
x1



x4

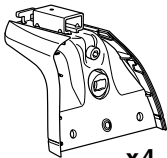

751

x4



x4



x4



12 mm  
x8

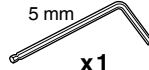

5 mm  
x1



x4



x1

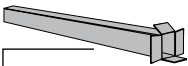

x2

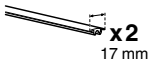

x2

17 mm

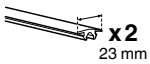

x2

23 mm

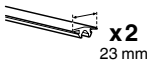

x2

23 mm

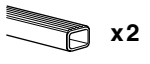

x2

23 mm

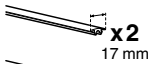

x2

17 mm

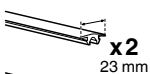

x2

23 mm

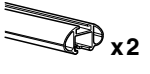

x2

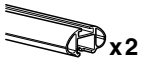

x2

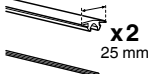

x2

25 mm

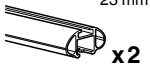

x2



x4

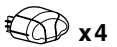

x4



x4



x2

x2



x4

x4



x1  
5 mm

1

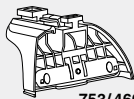

753/460R

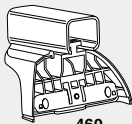

460

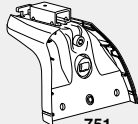

751

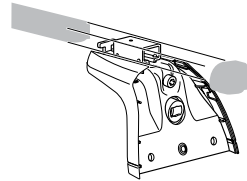
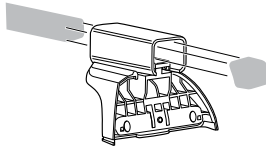
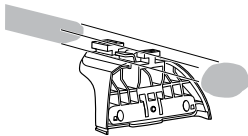

x4

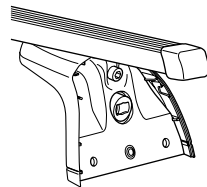
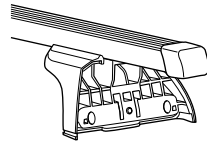
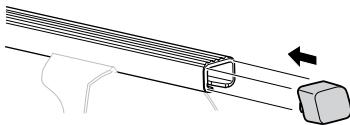

x4

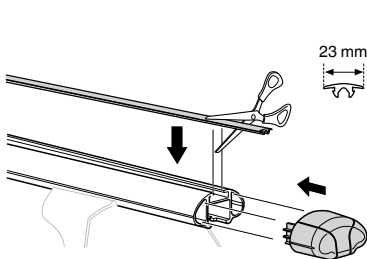

23 mm

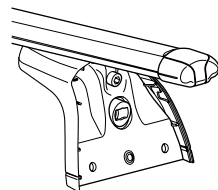
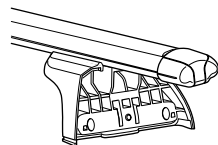
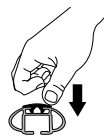



x4

x4

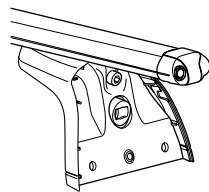
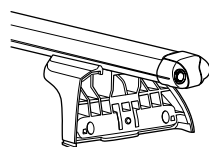
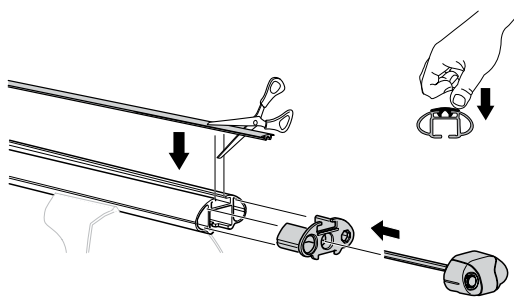

x4

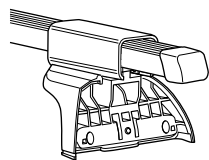
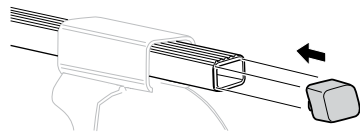

x2

x2

x4

x4

x1  
5 mm

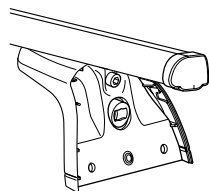
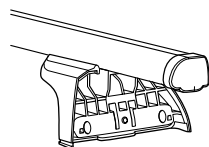
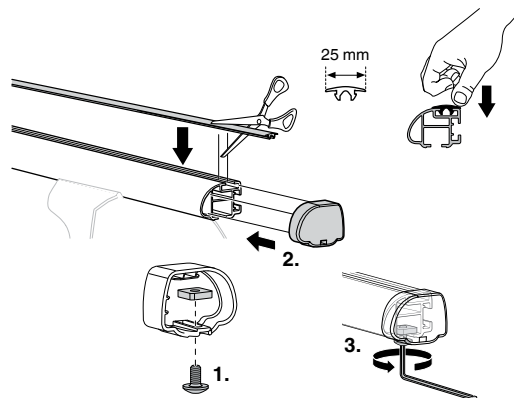

2

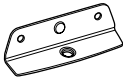

21 x 4

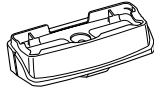

07 x 4



x 8



x 1

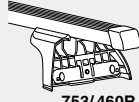

753/460R

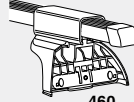

460

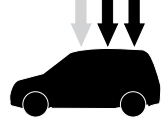

21



07



21

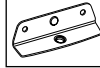

07

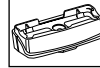

21



07



21

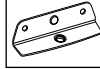

07

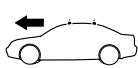
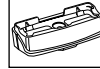

i

- GB** Only a few turns  
**D** Nur wenige Umdrehungen  
**F** Quelques tours uniquement  
**NL** Slechts enkele slagen  
**I** Solo qualche giro  
**E** Sólo algunas vueltas  
**PT** Noções básicas  
**S** Endast några varv  
**FIN** Vain muutama kierros  
**EST** Ainult mõni pööre  
**LAT** Tikai daži apgriezieni  
**LIT** Tik keli pasukimai  
**PL** Wystarczy kilka obrotów  
**RU** Достаточно нескольких оборотов  
**CZ** Pouze několik otáček  
**SK** Len niekoľko otáčok  
**SLO** Le nekaj obratov

- HR** Samo nekoliko okreta  
**HU** Csak néhány fordítás  
**GR** Μόνο μερικές στροφές  
**TR** Yalnız birkaç kez çevirm  
**中文** 只有几个转向  
**한국어** 두 세번만  
**日本語** 数回転のみ  
**ไทย** หมุนเพียงไม่กี่รอบ

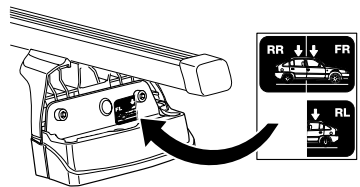
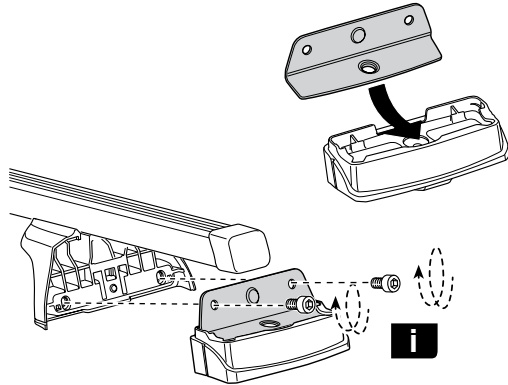

2

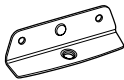

21 x 2

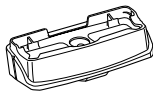

07 x 2

12 mm  
x 8

x 1

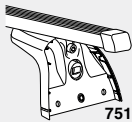

751

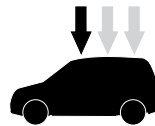

21



07



21



07

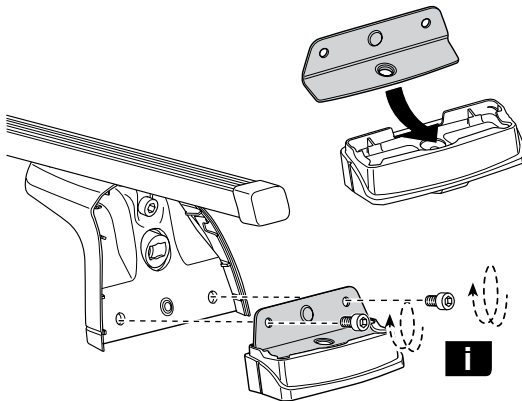
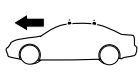
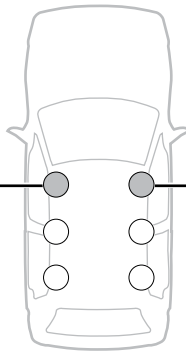
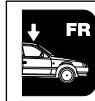
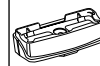

i

- GB** Only a few turns  
**D** Nur wenige Umdrehungen  
**F** Quelques tours uniquement  
**NL** Slechts enkele slagen  
**I** Solo qualche giro  
**E** Sólo algunas vueltas  
**PT** Noções básicas  
**S** Endast några varv  
**FIN** Vain muutama kierros  
**EST** Ainult mõni pööre  
**LAT** Tikai dažī apgriezieni  
**LIT** Tik keli pasukimai  
**PL** Wystarczy kilka obrotów  
**RU** Достаточно нескольких оборотов  
**CZ** Pouze několik otáček  
**SK** Len niekoľko otáčok  
**SLO** Le nekaj obratov

- HR** Samo nekoliko okreta  
**HU** Csak néhány fordítás  
**GR** Μόνο μερικές στροφές  
**TR** Yalnız birkaç kez çevirm  
**中文** 只有几个转向  
**한국어** 두 세번만  
**日本語** 数回転のみ  
**ไทย** หมุนเพียงไม่กี่รอบ

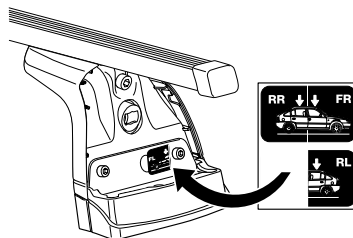

**3**

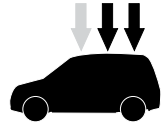
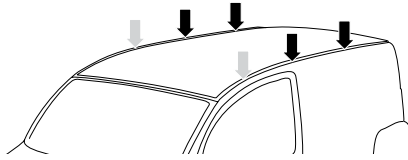
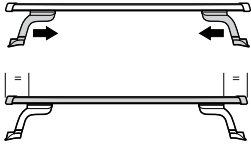
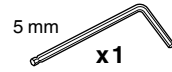
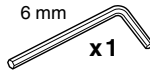
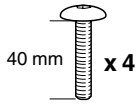

**A**

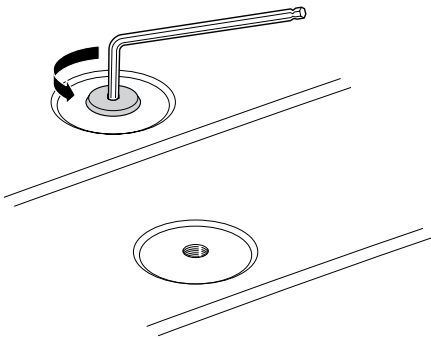

**B**

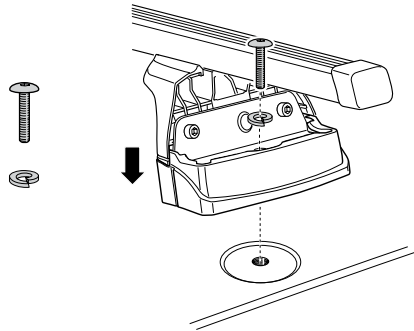

**C**

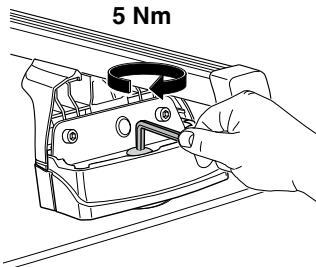

**D**

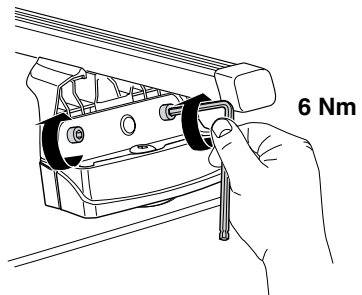

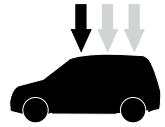
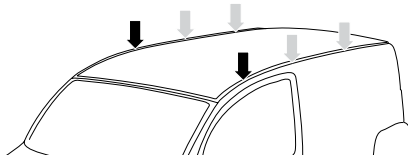
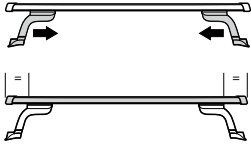
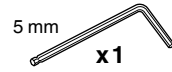
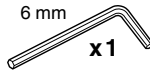
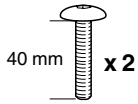
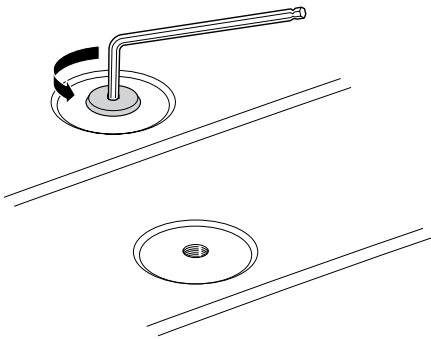

**3****A****B**

751

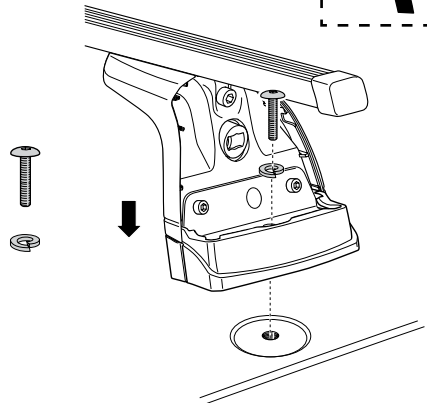
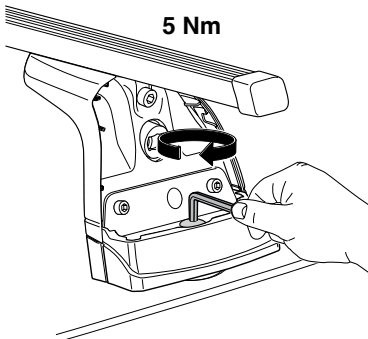
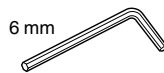
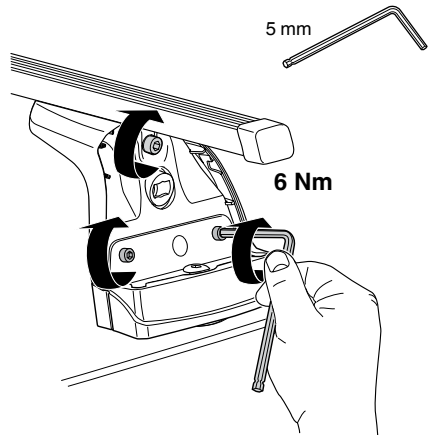
**C****D**

**4**



**x4**

753



**x4**



**x1**

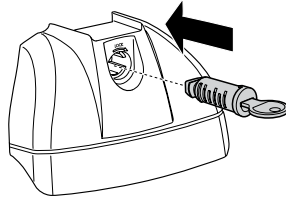

**x4**

460/460R



**x4**

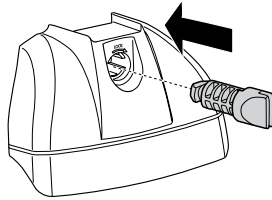

**x4**

751



**x4**



**x1**

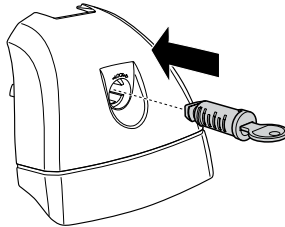

**5**



753

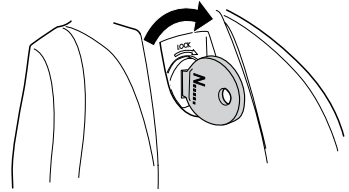
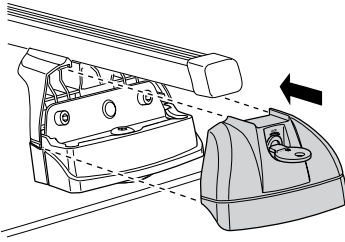

460/460R

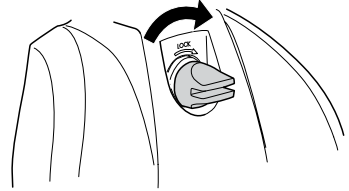
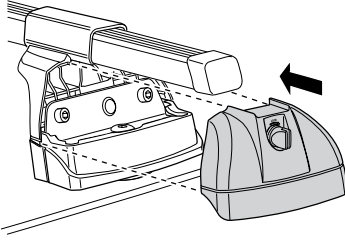

5 mm

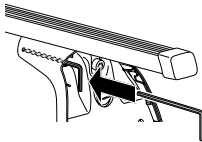

751

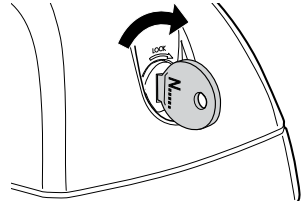
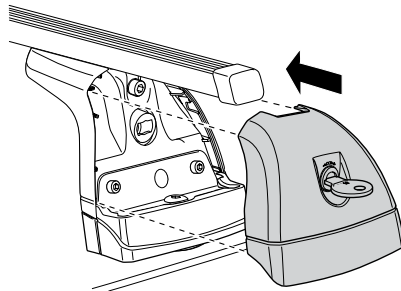

**6**

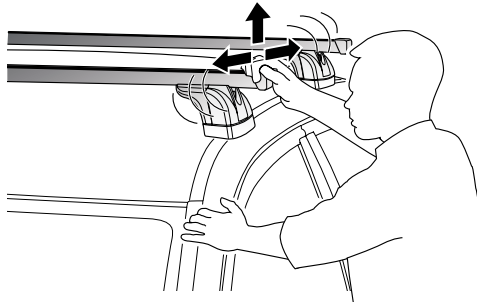

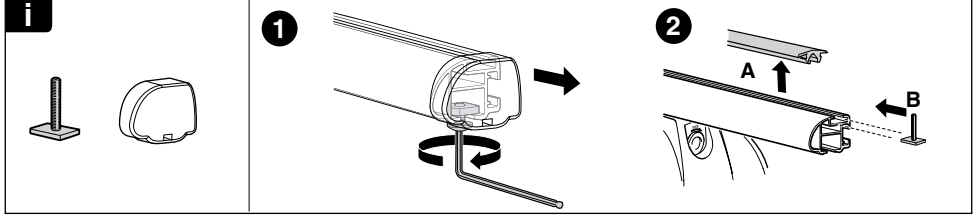
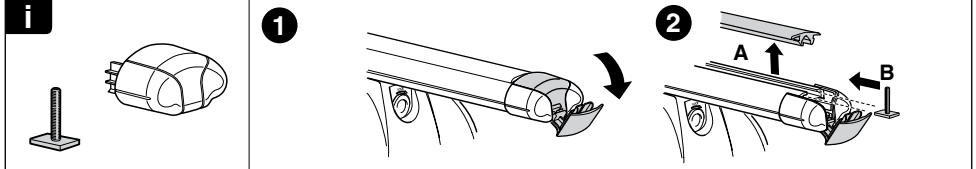
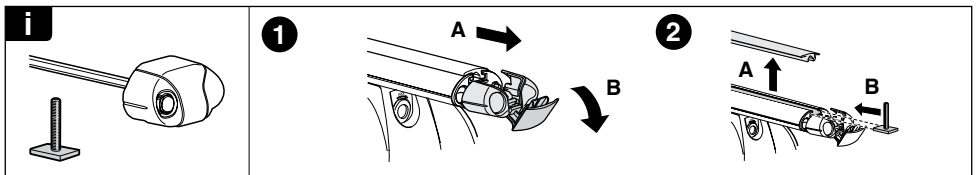
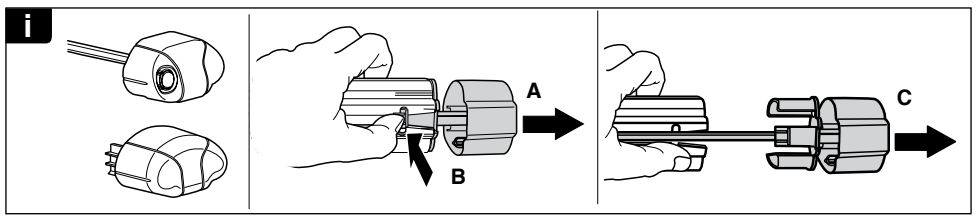
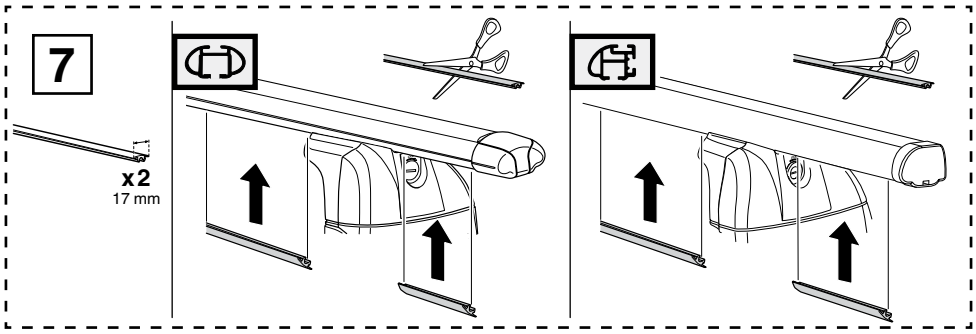

**THULE**  
SWEDEN  
**ONE  
KEY  
SYSTEM**

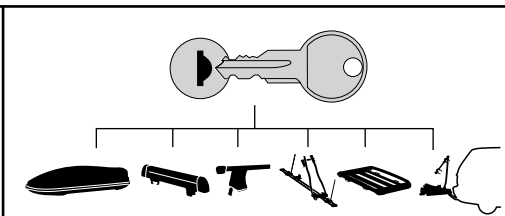

- 544 (x4)
- 596 (x6)
- 588 (x8)
- NA 510 (x10)
- EUR 452 (x12)
- ASIA